

MAHLE

VÁLVULAS, GUIAS E SEDES DE VÁLVULAS

VALVES, GUIDES AND VALVE SEATS

VÁLVULAS, GUÍAS Y ASIENTOS DE VÁLVULAS



Aftermarket 2019 / 2020

WWW.MAHLE-AFTERMARKET.COM

 **MAHLE**[®]
METAL
LEVE[®]

Índice

P

Catálogos adicionais	Página	3
Informações técnicas		
Tipos e termos técnicos	Página	4
Função	Página	5
Recomendações de montagem	Página	6
Dimensões	Página	7
Uso do catálogo		
Estrutura da página e decodificação dos códigos das peças	Página	8
Relação das válvulas por ordem alfabética de fabricante de motor ou veículo ..	Página	25-71
Lista de conversão	Página	72-126
Guias de Válvulas		
Introdução	Página	128
Informações técnicas		
Tipos e termos técnicos	Página	129
Função	Página	130
Uso do catálogo		
Estrutura da página e decodificação dos códigos das peças	Página	131
Relação das guias de válvulas por ordem alfabética de fabricante de motor ou veículo ..	Página	140-161
Lista de conversão	Página	162-172
Sedes de Válvulas		
Introdução	Página	174
Informações técnicas		
Tipos e termos técnicos	Página	175
Função	Página	175
Uso do catálogo		
Estrutura da página e decodificação dos códigos das peças	Página	176
Relação das sedes de válvulas por ordem alfabética de fabricante de motor ou veículo ..	Página	183-191
Lista de conversão	Página	192-199
P Sobre este catálogo	Página	1-8
EN About this catalogue	Page	9-16
ES Acerca de este catálogo	Página	17-24

**OS PRODUTOS DA MAHLE POSSUEM
CERTIFICAÇÃO COMPULSÓRIA**

JOGOS DE ANÉIS
PISTON RING SETS
JUEGOS DE ANILLOS



FILTROS
FILTERS
FILTROS



Aftermarket 2019/2020
WWW.MAHLE-AFTERMARKET.COM

MAHLE
METAL LEVE

MAHLE
METAL LEVE

Catálogos adicionais

Além deste catálogo*, a MAHLE Metal Leve disponibiliza o seguinte material informativo:

- Catálogo de Pistões, Camisas, Kits e Bronzinas;
 - Catálogo de Jogos de Anéis;
 - Catálogo de Filtros;
- Catálogos de Juntas Linha Pesada e Linha Leve.
- Você pode encontrar uma versão mais atualizada de nossos catálogos em nossa página web (www.mahle-aftermarket.com).

OS PRODUTOS DA MAHLE POSSUEM CERTIFICAÇÃO COMPULSÓRIA

Os produtos MAHLE que possuem certificação compulsória do INMETRO, de acordo com as portarias 301/11, 275/12, 16/13 e 29/15, são: pistões de liga leve de alumínio (Ciclo Otto e Diesel), pinos de pistão, anéis de pistão, bronzinas planas, bronzinas com flange, buchas e arruelas de encosto. A MAHLE coloca dois canais de contato exclusivos à disposição de seus parceiros que desejam saber mais sobre a Certificação Compulsória para Componentes Automotivos: acesse www.certificacaomahle.com.br ou envie sua mensagem para duvidas.certificacao@br.mahle.com.

*TODOS OS DIREITOS RESERVADOS PARA A MAHLE METAL LEVE S.A. Proibida a comercialização e/ou reprodução total ou parcial desta obra, por qualquer meio ou processo, especialmente por sistemas gráficos, microfílmicos, fotográficos, reprográficos, fonográficos e videográficos. Vedada a memorização e/ou a recuperação total ou parcial, bem como a inclusão de qualquer parte desta obra em qualquer sistema de processamento de dados. Essas proibições também aplicam-se às características gráficas da obra e à sua editoração. A violação dos direitos autorais é punível com crime (art. 184 e parágrafos do Código Penal), com pena de prisão e multa, busca e apreensão e indenizações diversas (arts. 101 a 110 da Lei 9.610 de 19.02.1998, Lei dos Direitos Autorais).

Tipos e termos técnicos

Válvulas monometálicas

São produzidas eficientemente por processo de extrusão a quente ou por estampagem.

SH = Válvula com sede temperada

N = Válvula nitretada

CP = Válvula com haste cromada

Válvulas bimetálicas

Tornam possível o uso da combinação ideal de materiais tanto na haste como na cabeça.

Válvulas ocas

Servem de um lado para reduzir o peso e, de outro, a temperatura. Preenchidas com sódio (ponto de fusão a 97,5°C), o efeito do movimento do sódio líquido faz com que o calor possa se deslocar da cabeça da válvula à sua haste, conseguindo assim uma redução da temperatura de 80°C a 150°C.

Materiais

CS = Aço baixo carbono para válvulas de admissão, também utilizado como material da haste em válvulas bimetálicas

M = Aço cromo cílio para válvulas de admissão e de escape em serviços moderados, também utilizado na haste, em válvulas bimetálicas

MN = Aço cromo silício níquel para válvulas de admissão com grande resistência à corrosão e às altas temperaturas

MV = Aço cromo molibdênio vanádio para válvulas de admissão com alta resistência ao desgaste, à corrosão e às altas temperaturas

A = Aço austenítico cromo níquel manganês para válvulas de escape resistentes a severas condições de operação

AN = Aço austenítico cromo níquel para válvulas de escape resistentes a severas condições de operação

AB = Aço austenítico cromo níquel manganês para válvulas de escape resistentes a severas condições de operação

X = Superligas para válvulas de escape altamente solicitadas

ST = Altas ligas para blindagem da sede de válvula com alta resistência à oxidação, ao desgaste e à corrosão

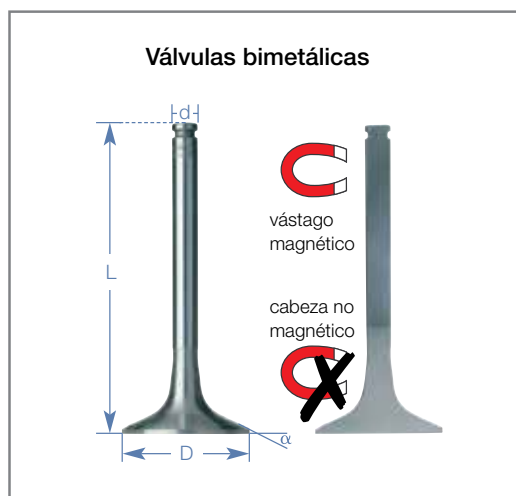
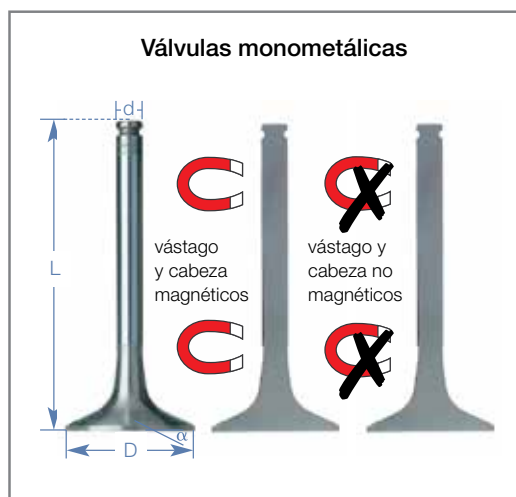

Função

Válvulas são autopeças de alta precisão que precisam executar quatro tarefas importantes no motor:

- vedar as áreas de fluxo;
- controlar a troca de gases;
- selar os cilindros do exterior;
- dissipar o calor absorvido dos gases de escape da combustão, transferindo-o para o anel de assento de válvula e para a guia de válvula.

Trabalhando a temperaturas acima de 800°C, cada válvula abre e fecha até 70 vezes por segundo e durante a vida do motor está sujeita a uma média de 300 milhões de alternâncias de carga.

Existe uma diferença genérica entre válvulas de admissão e de escape:

Válvulas de admissão

As válvulas de admissão – que são refrigeradas pelos gases não queimados – necessitam resistir a tensões mecânicas elevadas, especialmente em seu contato com o assento de válvula.

Válvulas de escape

Além das grandes demandas mecânicas a que estão submetidas, as válvulas de escape também têm que suportar altas tensões térmicas e corrosão química. Por isso, elas requerem materiais especiais e processos de produção mais complexos durante a sua fabricação.

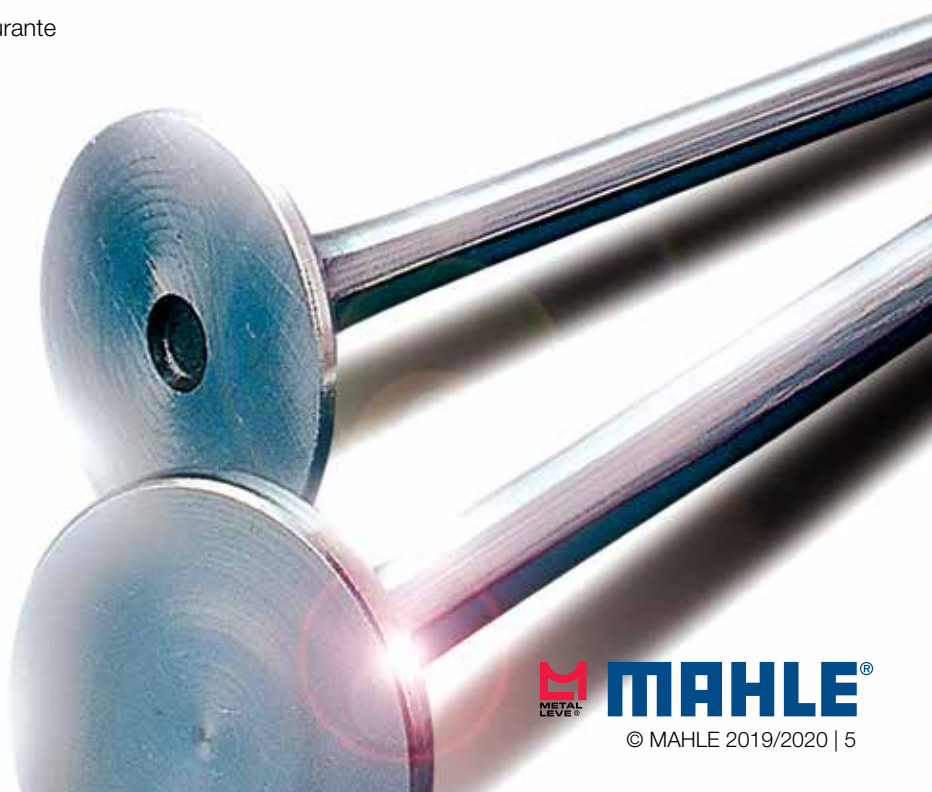
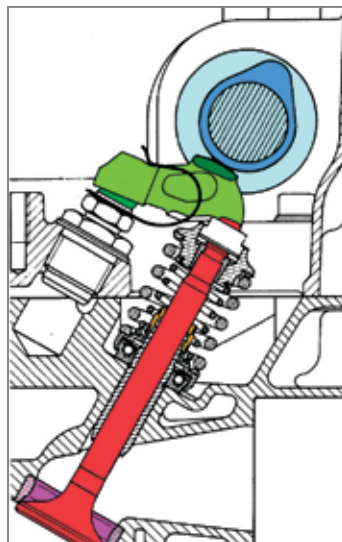

Recomendações de montagem

As válvulas são componentes de motores sujeitos às maiores tensões térmicas e mecânicas. Sua vida útil – e, por consequência, a vida útil do motor – dependem grandemente de sua instalação correta.

As válvulas MAHLE Original e Metal Leve são fornecidas em embalagem individual, prontas para ser instaladas.

Verifique as válvulas antes de instalá-las a fim de se certificar de que não foram danificadas (por exemplo, se não sofreram impactos, etc.). Nunca instale válvulas danificadas ou tortas. Tenha a certeza de estar usando as válvulas corretas para o seu motor.

Válvulas MAHLE Original e Metal Leve somente deverão ser usadas nas aplicações para as quais foram projetadas. Em nenhuma circunstância, elas deverão ser trabalhadas ou modificadas mecanicamente.

As informações e instruções de instalação do fabricante do motor devem ser observadas em todos os casos.

Antes de instalar a válvula, verifique o interior da cabeça da mola de válvula para ver se ela está gasta ou danificada. Observe também se a força da mola de válvula está dentro dos valores prescritos pelo fabricante do motor.



Assegure-se de usar novos cliques e selos de haste de válvula quando instalar a válvula.

A haste de válvula deve ser lubrificada adequadamente com óleo limpo de motor antes da sua inserção.

Dimensões

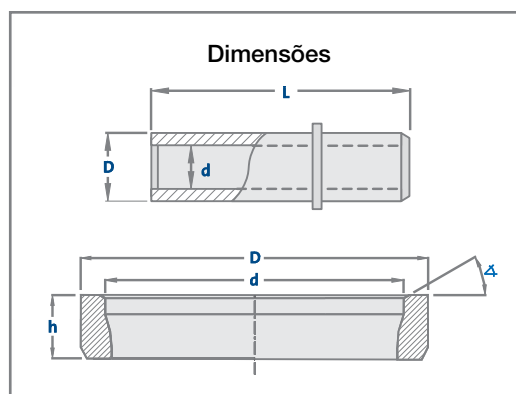
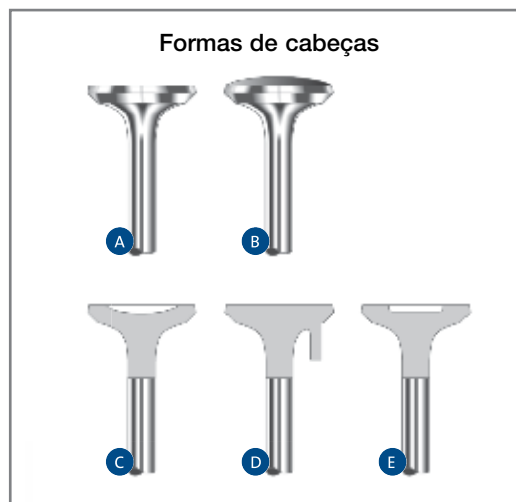
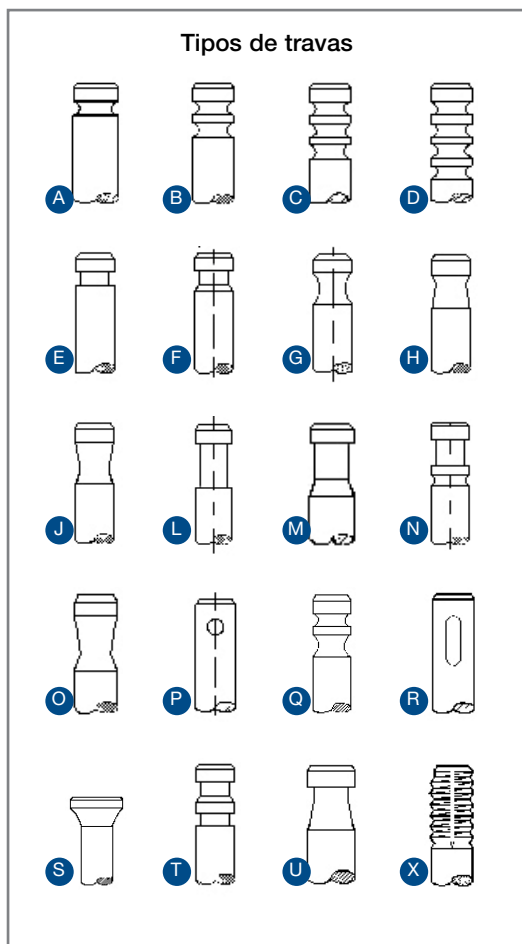
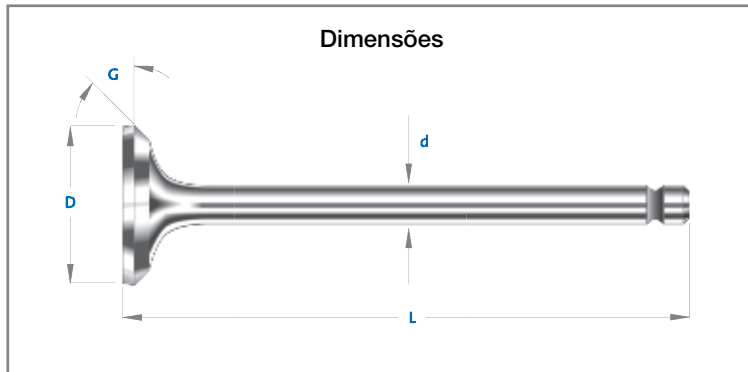

Estrutura da página e decodificação dos códigos das peças

1 FIAT		MAHLE							
		Nº CIL.	TIPO TYPE						
2	3	4	5	6	7	8	9	10	
127,147, Spazio, Vivace, Uno, Duna, Fiorino (1100-1300) - GNC	4	IN	36.00 x 7.98 x 108.50	M/CP	45°30'	A	A	VA0250060	
	EX	33.13 x 7.98 x 108.95	A/CP/ST	Stellit 44°30'	A	A	VE0250059		
128, 147, Spazio, Vivace, Uno, Duna, Fiorino (1100-1300) - Nafta / GNC	4	EX	31.00 x 7.98 x 109.00	A/ST/CP	44°30'	A	A	VE0250053	
	IN	36.00 x 7.98 x 108.50	M/CP	45°30'	A	A	VA0250060		
128, Motor 1500cc.	4	IN	36.00 x 7.98 x 108.50	M/CP	45°30'	A	A	VA0250060	
147, UNO, PREMIO, ELBA, MILLE - 1000/1050/1300	4	IN	34.03 x 7.97 x 110.15	A/M/CP	44°30'	A	A	VA0250002	
147, Uno, Premio, Elba, Mille, Brio Motor 1000-1050-1300-1500cc.	4	IN	34.03 x 7.97 x 110.15	A/M/CP	44°30'	A	A	VA0250002	
	EX	28.98 x 7.98 x 110.60	A/CP	44°30'	A	A	VE0250001		
147, Uno, Spazio, Vivace, Duna Motor Tipo 1400-1600cc. 1378N (Nafta / GNC)	4	EX	31.00 x 7.98 x 109.00	A/ST/CP	44°30'	A	A	VE0250053	
	IN	30.05 x 6.98 x 113.15	A/M/CP	45°30'	D	A	VA0250160		
Brava, Bravo, Marea 2000cc. 20v.	4	EX	26.10 x 6.97 x 108.58	A/CP/M/ST	45°30'	D	A	VE0250161	
	IN	30.40 x 6.99 x 102.50	M/CP	44°30'	A	C	VA0250165		
Bravo, Palio, Siena, Marea Motor 1580cc. 16v. injeção (Nafta / GNC)	4	EX	29.90 x 6.99 x 102.35	A/CP/ST	45°30'	A	C	VE0250164	
	IN	36.45 x 7.98 x 110.20	M/CP	45°	A	A	VA0250018		
Duna, Uno, Fiorino, 1.3 MPI - Nuevo Palio 1.3 MPI 8v.	4	IN	26.90 x 5.99 x 95.20	M/CP/SH	44°30'	C	C	VA0250166	
Fire 16v. 1.0l. Palio - 1.3lts. 80CV Dobló, Dobló Cargo - GNC	4	IN	26.90 x 5.99 x 95.20	M/CP/SH	44°30'	C	C	VA0250166	
	EX	22.40 x 5.98 x 96.18	AB/M/ST	45°	C	A	VE0250163		
Fire 16v. Palio 1000cc.- Palio, Siena, Strada, Dobló, Dobló Cargo 1300cc. 80CV	4	IN	31.40 x 6.99 x 97.00	M/CP/SH	45°50'	A	C	VA0250162	
	EX	27.35 x 6.99 x 97.20	A/ST/CP	44°30'	A	A	VE0250167		
Fire 8v. 65CV-Mille(Uno), Palio, Palio Nuevo, Siena 1.3lts. 67CV, Palio Weekend, Siena, Uno Furgão, Fiorino Furgão, Picape Strada - GNC	4	IN	31.40 x 6.99 x 97.00	M/CP/SH	45°50'	A	C	VA0250162	
	EX	27.35 x 6.99 x 97.20	A/ST/CP	44°30'	A	A	VE0250167		
Fire 8v. 65CV-Mille(Uno), Uno Furgão, Fiorino Furgão, Strada, Palio, Palio Weekend, Siena 1300cc.	4	IN	31.40 x 6.99 x 97.00	M/CP/SH	45°50'	A	C	VA0250162	

1 Fabricante

2 Nome do motor

Dados do motor

Veículos

Ano de fabricação

3 Número de cilindros

4 Função

IN = Admissão

EX = Escape

IN - EX = Comum

5 Dimensões da válvula em mm

6 Materiais da válvula/Revestimento da válvula

Ex.: A/M/ST/CP

Revestimento

Material de construção

7 Revestimento do assento de válvula/Ângulo do assento de válvula

8 Identificação da forma da haste da válvula

9 Forma da cabeça

10 Número de artigo da válvula

Ex.: VA0250002

Número sequencial

Linha motora

Overview

EN

english

Additional catalogues	Page	11
Technical information		
Types and technical terms	Page	12
Function	Page	13
Fitting recommendations	Page	14
Dimensions	Page	15
Catalogue applications		
Page structure and decoding of part numbers	Page	16
List of valves in alphabetical order of engine or vehicle manufacturer	Page	25-71
Cross reference	Page	72-126
Valve Guides		
Introduction	Page	132
Technical information		
Types and technical words	Page	133
Purpose	Page	134
Catalogue applications		
Page structure and part code decoding	Page	135
List of valve guides in alphabetical order of engine or vehicle manufacturer	Page	140-161
Cross reference	Page	162-172
Valve Seats		
Introduction	Page	177
Technical information		
Types and technical words	Page	178
Purpose	Page	178
Catalogue applications		
Page structure and part code decoding	Page	179
List of valve seats in alphabetical order of engine or vehicle manufacturer	Page	183-191
Cross reference	Page	192-199
P Sobre este catálogo	Página	1-8
EN About this catalogue	Page	9-16
ES Acerca de este catálogo	Página	17-24

MAHLE PRODUCTS HAVE MANDATORY CERTIFICATION

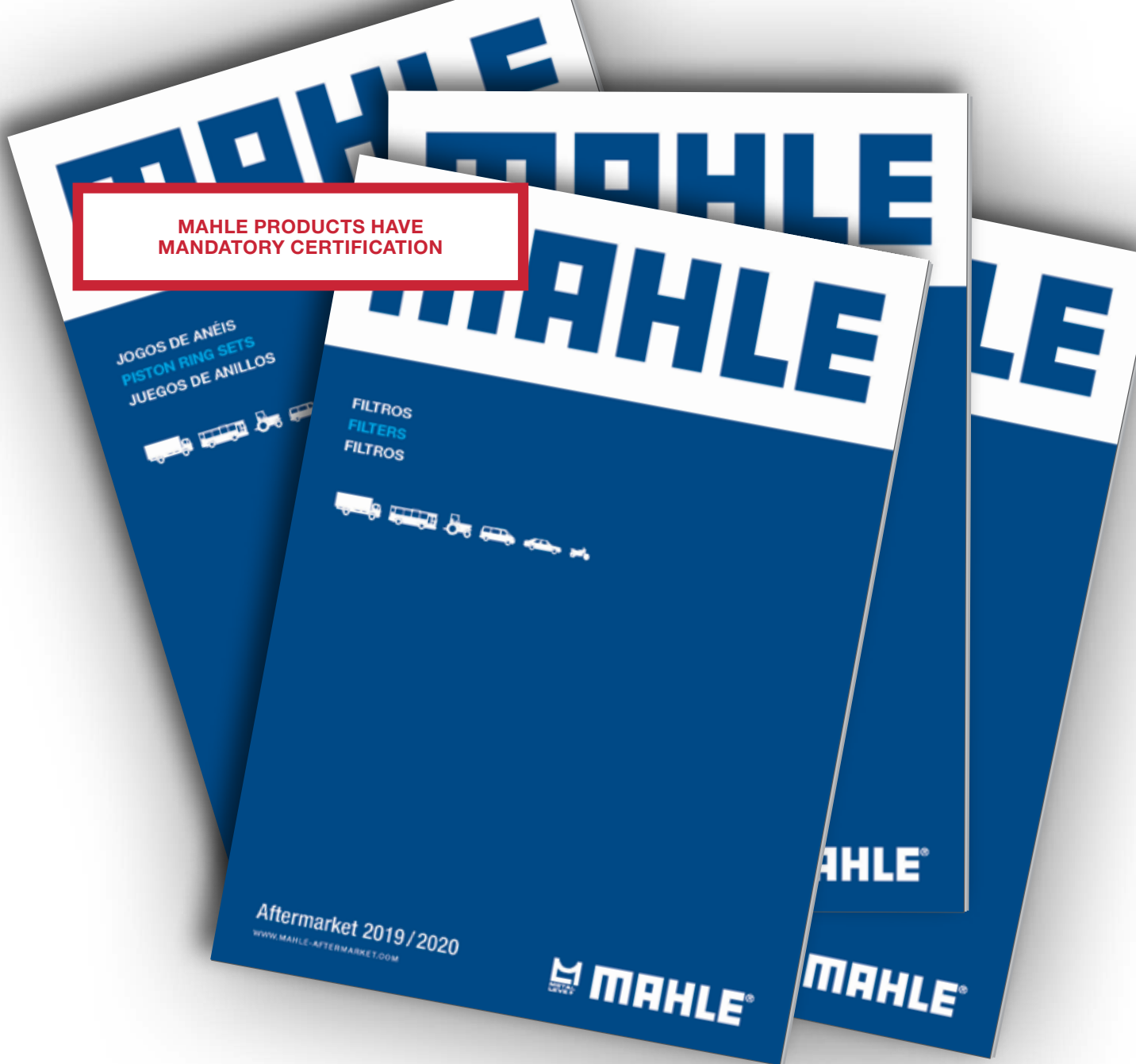

Additional catalogues

In addition to this catalogue*, the following information material is available from MAHLE Metal Leve:

- Valves, Guides and Valve Seats Catalogue
 - Catalogue for Filters
 - Catalogue for Piston, Cylinders, Kits and Bearings
 - Catalogue for Piston Ring Sets
- You can find an updated version of our catalogs on our website (www.mahle-aftermarket.com).

MAHLE'S PRODUCTS HAVE COMPULSORY CERTIFICATION

MAHLE's products with the INMETRO compulsory certification, according to Ordinances 301/11, 275/12, 16/13 and 29/15, include: lightweight aluminum alloy pistons (Otto and Diesel Cycle), piston pins, piston rings, plain bearings, flanged bearings, bushings, and thrust washers. MAHLE provides two unique contact channels for its partners who wish to learn more about the Compulsory Certification for Automotive Components. Please visit www.certificacaomahle.com.br or send your message to duvidas.certificacao@br.mahle.com.

*ALL RIGHTS RESERVED TO MAHLE METAL LEVE S.A. It is strictly prohibited any trading and/or total or partial copying of this work, by any way or process, mainly by graphic systems, microfilm, photographic, reprographics, phonographs and video graphics. Forbidden memorization and/or total or partial recover, as well the inclusion of any part of this work at any data processing system. These prohibitions also apply for graphics characteristics of this work and its publishing. Violation of authorial rights is punished as criminal (art. 184 and paragraphs of Penal Code), prison punishment and fine, search and attachment and indemnity (arts. 101 to 110 of Law 9.610 of 19.02.1998, Law of Authorial Rights).

Types and technical terms

Mono-metallic valves

Are produced efficiently in a warm-extruded process or in an upsetting process.

- SH = Seat hardening
- N = Nitriding
- CP = Chrome plating

Bi-metallic valves

Make it possible to use the ideal combination of materials both for the shaft and the head.

Hollow valves

Serve on the one hand to reduce weight, and on the other hand to reduce the temperature. Filled with sodium (melting point 97.5° C), the shaker effect of the liquid sodium means that heat can travel from the valve head to the valve shaft and a temperature reduction of between 80° and 150° C can be achieved.

Materials

- CS = Low alloy carbon steel alloys for intake valves also used as stem materials in bi-metallic valves
- M = High alloyed chrome-silicon steel for intake and exhaust valves in medium services, also used as stem material in bi-metallic valves
- MN = High alloyed chrome-silicon-nickel steel for intake valves with strong resistance against corrosion and high temperatures
- MV = High alloyed chrome-molybdenum-vanadium steel for intake valves with strong resistance against wear, corrosion and high temperatures
- A = Austenitic chromium-manganese-nickel steel for exhaust valves resistant to severe operating conditions
- AN = Austenitic chromium-nickel steel for exhaust valves resistant to severe operating conditions
- AB = Austenitic chromium-manganese-nickel steel for exhaust valves resistant to severe operating conditions
- X = Super alloys for exhaust valve application in extreme conditions
- ST = High alloys for facing on the valve seat with high resistance to oxidation, wear and corrosion

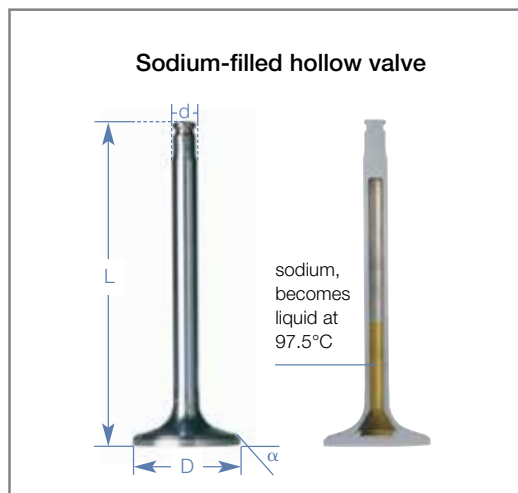
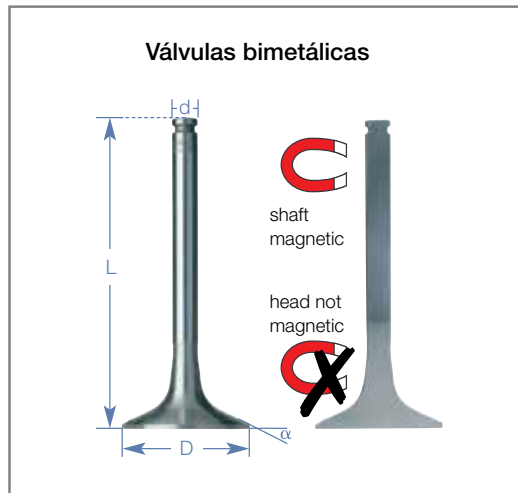
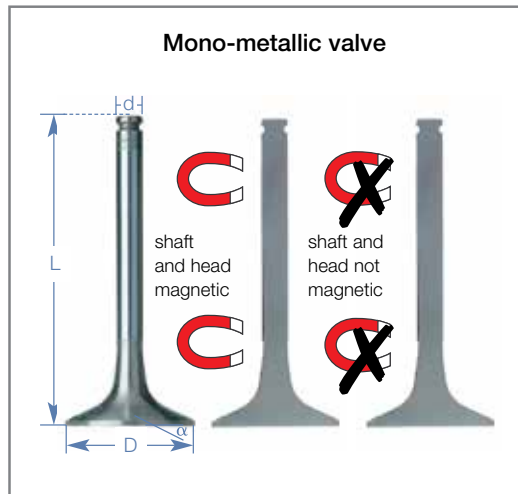

Function

Valves are precision engine parts and they have to perform four important tasks in the operation of the engine:

- Blocking flow areas
- Controlling gas exchange
- Sealing the cylinders to the outside
- Dissipating the heat absorbed by the exhaust gases from combustion to the valve seat ring and to the valve guide.

At temperatures of up to 800° C, each valve opens and closes up to 70 times per second and during the life of the engine it is subjected to an average of 300 million changes of load.

A distinction is generally made between intake valves and exhaust valves.

Intake valves

The valves – which are cooled by the circulation of unburnt gases – have to withstand high mechanical loads, especially upon contact with the valve seat.

Exhaust valves

In addition to the great mechanical demands made on them, exhaust valves are subjected to high thermal stresses and chemical corrosion. Therefore, other materials and more complex production processes are used when they are manufactured.

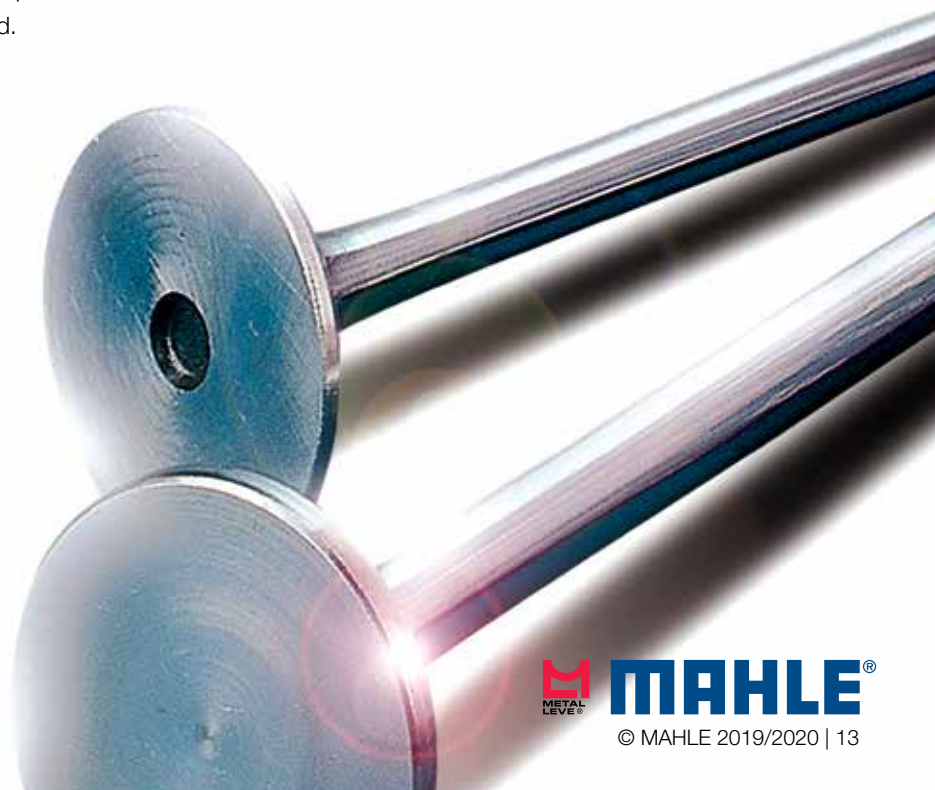
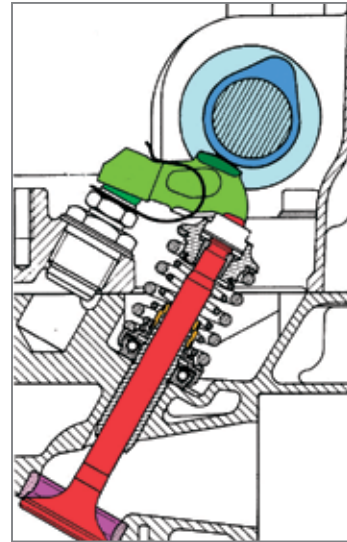

Fitting recommendations

Valves are some of the components in the engine that are subjected to the greatest thermal and mechanical stresses. Their working life – and thus the working life of the engine – is strongly dependent on their being installed correctly.

MAHLE Original and Metal Leve valves are supplied ready for installation and individually packed.

Check the valves before installation to see if they have been damaged (for example, if they have been knocked etc.). Never install damaged or bent valves. Make sure that the valves are the right size for your engine.

MAHLE Original and Metal Leve valves are only to be used in the application for which they were designed; under no circumstances may they be mechanically processed or changed.

Information and installation guidelines from the engine manufacturer must be observed in all cases.

Before installing the valve, check the inner core of the valve spring head to see if it is worn or damaged. Check also whether the valve spring power is still within the values prescribed by the engine manufacturer.



Be sure to use new valve collets and valve shaft seals when installing the valve.

The valve shaft must be lubricated sufficiently with clean engine oil before it is inserted.

Dimensions

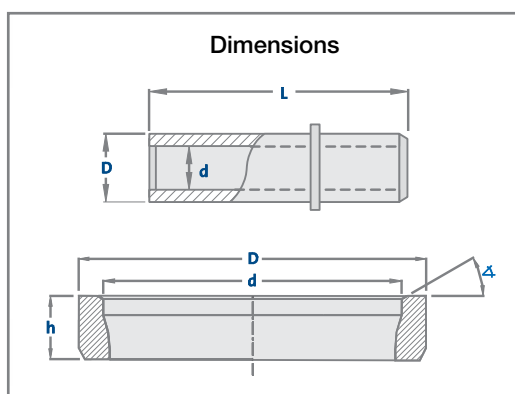
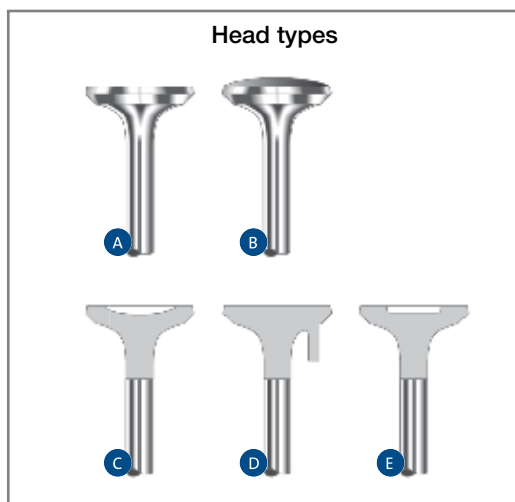
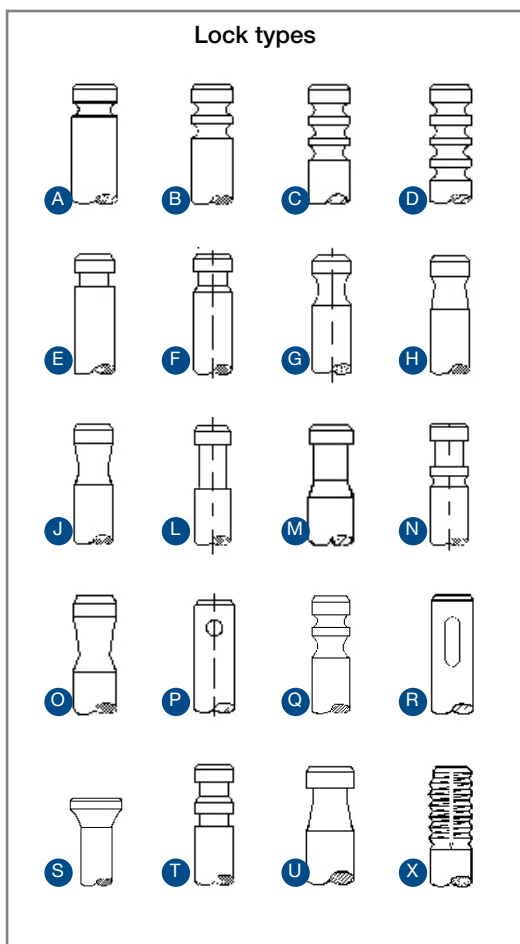
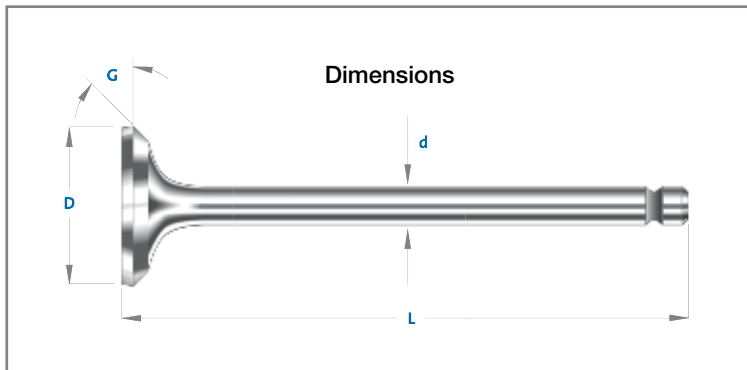

Page structure and decoding of part numbers

1 FIAT		MAHLE							
		N° CIL.	TIPO TYPE						
2		3	4	5	6	7	8	9	10
127, 147, Spazio, Vivace, Uno, Duna, Fiorino (1100-1300) - GNC	4	IN	36.00 x 7.98 x 108.50	M/CP	45°30'	A	A		VA0250060
		EX	33.13 x 7.98 x 108.95	A/CP/ST	Stellit 44°30'	A	A		VE0250059
128, 147, Spazio, Vivace, Uno, Duna, Fiorino (1100-1300) - Nafta / GNC	4	EX	31.00 x 7.98 x 109.00	A/ST/CP	44°30'	A	A		VE0250053
		IN	36.00 x 7.98 x 108.50	M/CP	45°30'	A	A		VA0250060
128, Motor 1500cc.	4	IN	36.00 x 7.98 x 108.50	M/CP	45°30'	A	A		VA0250060
147, UNO, PREMIO, ELBA, MILLE - 1000/1050/1300	4	IN	34.03 x 7.97 x 110.15	A/M/CP	44°30'	A	A		VA0250002
147, Uno, Premio, Elba, Mille, Brio Motor 1000-1050-1300-1500cc.	4	IN	34.03 x 7.97 x 110.15	A/M/CP	44°30'	A	A		VA0250002
		EX	28.98 x 7.98 x 110.60	A/CP	44°30'	A	A		VE0250001
147, Uno, Spazio, Vivace, Duna Motor Tipo 1400-1600cc. 1378N (Nafta / GNC)	4	EX	31.00 x 7.98 x 109.00	A/ST/CP	44°30'	A	A		VE0250053
		IN	30.05 x 6.98 x 113.15	A/M/CP	45°30'	D	A		VA0250160
Brava, Bravo, Marea 2000cc. 20v.	4	EX	26.10 x 6.97 x 108.58	A/CP/M/ST	45°30'	D	A		VE0250161
		IN	30.40 x 6.99 x 102.50	M/CP	44°30'	A	C		VA0250165
Bravo, Palio, Siena, Marea Motor 1580cc. 16v. injeção (Nafta / GNC)	4	EX	29.90 x 6.99 x 102.35	A/CP/ST	45°30'	A	C		VE0250164
		IN	36.45 x 7.98 x 110.20	M/CP	45°	A	A		VA0250018
Duna, Uno, Fiorino, 1.3 MPI - Nuevo Palio 1.3 MPI 8v.	4	IN	26.90 x 5.99 x 95.20	M/CP/SH	44°30'	C	C		VA0250166
Fire 16v. 1.0l. Palio - 1.3lts. 80CV Dobló, Dobló Cargo - GNC	4	IN	26.90 x 5.99 x 95.20	M/CP/SH	44°30'	C	C		VA0250166
		EX	22.40 x 5.98 x 96.18	AB/M/ST	45°	C	A		VE0250163
Fire 8v. 65CV-Mille(Uno), Palio, Palio Nuevo, Siena 1.3lts. 67CV, Palio Weekend, Siena, Uno Furgão, Fiorino Furgão, Picape Strada - GNC	4	IN	31.40 x 6.99 x 97.00	M/CP/SH	45°50'	A	C		VA0250162
		EX	27.35 x 6.99 x 97.20	A/ST/CP	44°30'	A	A		VE0250167
Fire 8v. 65CV-Mille(Uno), Uno Furgão, Fiorino Furgão, Strada, Palio, Palio Weekend, Siena 1300cc.	4	IN	31.40 x 6.99 x 97.00	M/CP/SH	45°50'	A	C		VA0250162

- 1 Manufacturer
- 2 Engine name
Engine data
Vehicles
Year of construction
- 3 Cylinder number
- 4 Function
IN = Intake
EX = Exhaust
IN - EX = Common
- 5 Valve dimensions in mm
- 6 Valve materials/Valve coating
Ex.: A/M/ST/CP

- 7 Valve seat coating/Valve seat angle
- 8 Identification of shaft end
- 9 Head shape
- 10 Valve article number

Ex.: VA0250002

Sequential number

Engine manufacturer codification

Sumario

ES

Catálogos adicionales	Página	19
Informaciones técnicas		
Tipos y conceptos técnicos	Página	20
Función	Página	21
Recomendaciones de montaje	Página	22
Dimensiones	Página	23
Uso del catálogo		
Configuración de las páginas y claves de los números de artículos	Página	24
Lista de válvulas por orden alfabético según fabricante de motor o vehículo ...	Página	25-71
Tabla de conversión	Página	72-126
Guías de Válvulas		
Prefacio	Página	136
Informaciones técnicas		
Tipos y conceptos técnicos	Página	137
Función	Página	138
Uso del catálogo		
Configuración de las páginas y claves de los números de artículos	Página	139
Lista de guías de las válvulas por orden alfabético según fabricante de motor o vehículo ..	Página	140-161
Tabla de conversión	Página	162-172
Asientos de Válvulas		
Prefacio	Página	180
Informaciones técnicas		
Tipos y conceptos técnicos	Página	181
Función	Página	181
Uso del catálogo		
Configuración de las páginas y claves de los números de artículos	Página	182
Lista de asientos de válvulas por orden alfabético según fabricante de motor o vehículo ..	Página	183-191
Tabla de conversión	Página	192-199
P Sobre este catálogo	Página	1-8
EN About this catalogue	Page	9-16
ES Acerca de este catálogo	Página	17-24

LOS PRODUCTOS DE MAHLE TIENEN
CERTIFICACIÓN OBLIGATORIA

JOGOS DE ANÉIS
PISTON RING SETS
JUEGOS DE ANILLOS

FILTROS
FILTERS
FILTROS

Aftermarket 2019/2020
WWW.MAHLE-AFTERMARKET.COM

MAHLE®

MAHLE®

español

Catálogos adicionales

Para completar el presente catálogo*, MAHLE Metal Leve ■ Catálogo de Juntas
también ofrece los siguientes materiales de consulta:

- Catálogo de Pistones, Camisas, Kits y Cojinetes
- Catálogo de Aros
- Catálogo de Filtros

Usted puede encontrar una versión más actualizada de nuestros catálogos en nuestra página web (www.mahle-aftermarket.com).

LOS PRODUCTOS DE MAHLE TIENEN CERTIFICACIÓN OBLIGATORIA

Los productos MAHLE que tienen certificación obligatoria del INMETRO, de acuerdo con las resoluciones 301/11, 275/12, 16/13 y 29/15, son: pistones de aleación liviana de aluminio (Ciclo Otto y Diesel), pernos de pistón, aros de pistón, cojinetes planos, cojinetes con axial, bujes y arandelas de empuje. MAHLE ofrece dos canales de contacto exclusivos a disposición de sus aliados que desean saber más sobre la Certificación Obligatoria para Componentes Automotrices, ingrese a www.certificacaomahle.com.br o envíe su mensaje a duvidas.certificacao@br.mahle.com.

*MAHLE METAL LEVE SE RESERVA DE TODOS LOS DERECHOS, prohibida la comercialización y/o reproducción total o parcial de esta obra, por cualquier medio o proceso, especialmente por sistemas gráficos, fotográficos, reprográficos, fonográficos, videográficos y de microfilmes. Prohibida la memorización y/o la recuperación total o parcial, así como la inclusión de cualquier parte de la obra en cualquier sistema de procesamiento de datos. Estas prohibiciones se aplican también a las características gráficas de la obra y a su edición. La violación de los derechos del autor reservados constituye un crimen (artículo 184 y párrafos del Código Penal de Brasil), con pena de prisión y multa, busca y aprehensión e indemnizaciones diversas (artículo 101 a 110 de la ley 9.610 de 19/02/1998, Ley de los Derechos Reservados del Autor de Brasil).

Válvulas monometálicas

Fabricadas racionalmente mediante proceso de extrusión en caliente o proceso de recalcado.

Válvulas bimetálicas

Hacen posible la combinación ideal de materiales tanto para el vástago como para la cabeza.

Válvulas huecas

Sirven por un lado para la reducción de peso y por otro para la disminución de temperatura. Rellena de sodio (punto de fusión 97,5° C), puede transportar calor desde la cabeza de la válvula hasta el vástago, a través del efecto agitador del sodio líquido, y lograr una disminución de la temperatura entre 80° hasta 150° C.

Materiales

- CS = Acero bajo carbono para válvulas de admisión también utilizada como material del vástago en válvulas bimetálicas
- M = Acero cromo silicio para válvulas de admisión y de escape en servicios moderados, aún utilizados como material del vástago en válvulas bimetálicas
- MN = Acero cromo níquel silicio para válvulas de admisión con gran resistencia a la corrosión y temperaturas elevadas
- MV = Acero cromo molibdeno vanadio para válvulas de admisión con alta resistencia al desgaste, corrosión y altas temperaturas
- A = Acero austenítico cromo níquel manganeso para válvulas de escape resistentes a pesadas condiciones de operación
- AN = Acero austenítico cromo níquel para válvulas de escape resistentes a severas condiciones de operación
- AB = Acero austenítico cromo níquel manganeso para válvulas de escape resistentes a pesadas condiciones de operación
- X = Super aleaciones para válvulas de escape fuertemente solicitadas
- ST = Altas aleaciones de blindaje del asiento de válvulas de alta resistencia a la oxidación,

desgaste y corrosión

SH = Válvula con asiento temperado

N = Válvula nitretada

CP = Válvula con vástago cromado

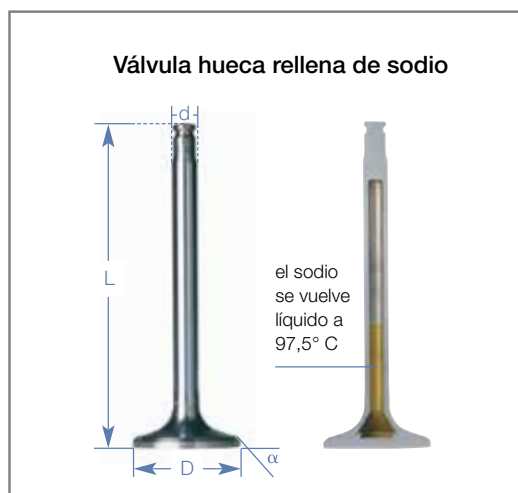
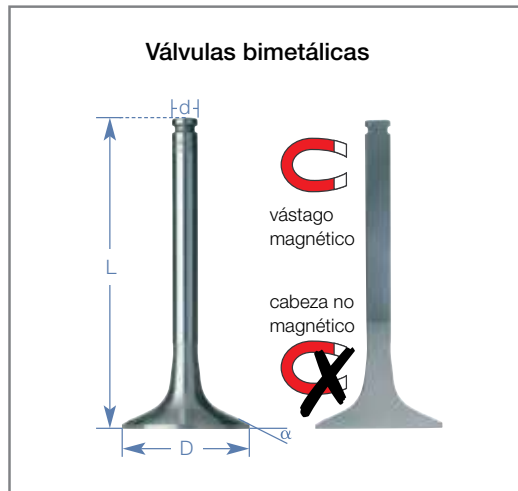
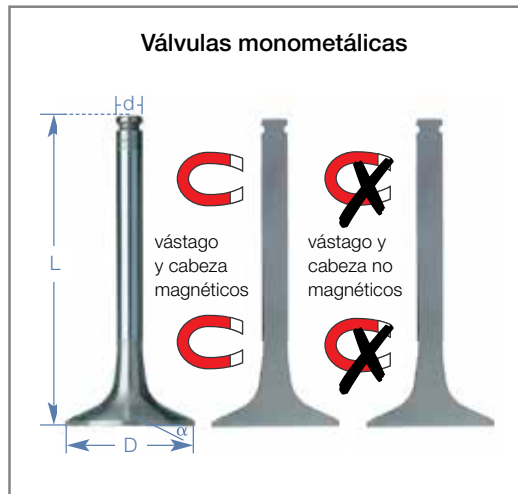

Función

Las válvulas son piezas de precisión del motor y cumplen cuatro tareas muy importantes en el funcionamiento motriz:

- Bloqueo de secciones del flujo
- Control del intercambio de gases
- Cierre hermético de los cilindros
- Disipación del calor absorbido de los gases de escape de la combustión, transfiriéndolo hacia los insertos de asiento de válvulas y hacia las guías de válvulas.

A temperaturas de hasta 800° Celsius cada válvula se abre y se cierra hasta 70 veces por segundo y durante la vida útil del motor soporta, como término medio, 300 millones de recambios de la carga.

Por lo general se distingue entre válvulas de admisión y de escape.

Válvulas de admisión

Como consecuencia de la circulación de los gases frescos, las válvulas de admisión enfriadas deben soportar elevadas cargas mecánicas sobre todo en el contacto con el asiento de la válvula.

Válvulas de escape

Adicionalmente a las elevadas sollicitaciones, las válvulas de escape están expuestas a elevadas cargas térmicas y corrosión química. Por ello, se emplean materiales especiales y procesos de producción más complejos durante su fabricación.

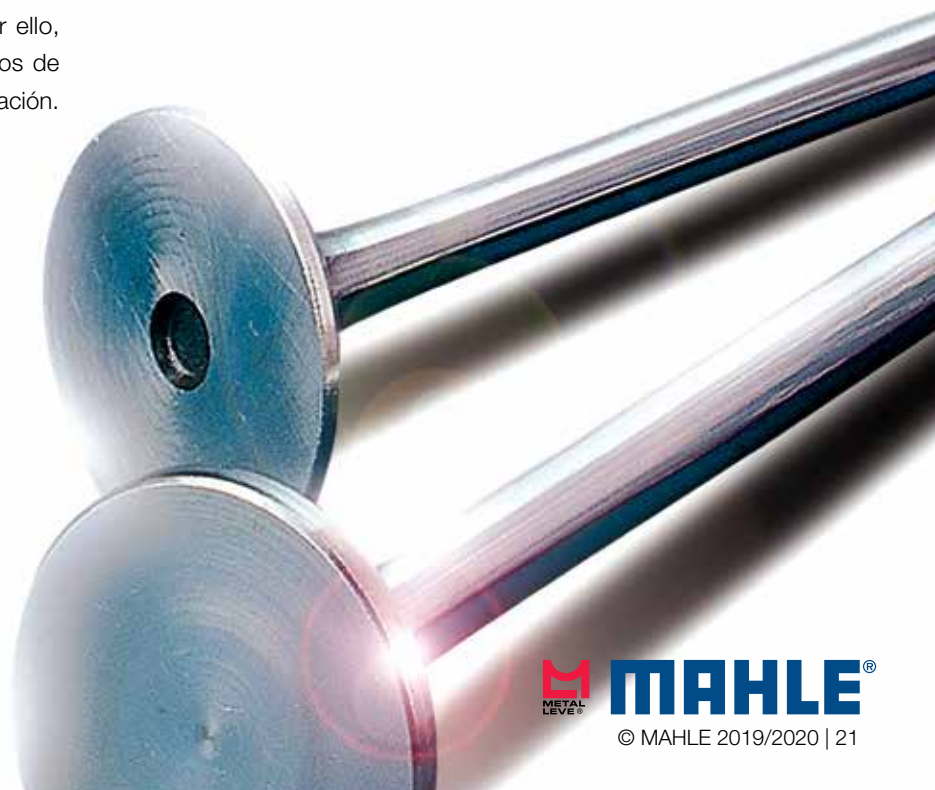
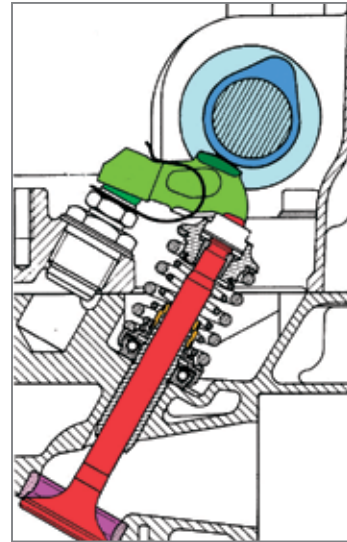

Recomendaciones de montaje

Las válvulas son componentes de motores, sujetos a las mayores tensiones térmicas y mecánicas. Su vida útil, y por consecuencia la vida útil del motor, depende fundamentalmente de su correcto montaje.

Las válvulas MAHLE Original y se suministran listas para el montaje y envasadas individualmente.

Antes del montaje, compruebe si existen eventuales daños en las válvulas (Ej.: por caída, etc.). Nunca lleve a cabo el montaje de válvulas dañadas o torcidas. Asegúrese de que las válvulas son las apropiadas para su motor.

Las válvulas MAHLE Original y solamente deben ser usadas en las aplicaciones para las cuales han sido diseñadas. No está permitido en ningún caso su adaptación o modificación.

Deben ser observados, en todos los casos, los datos e instrucciones de montaje del fabricante del motor.

Antes del montaje de la válvula compruebe que no existe desgaste o daños en el cono interior de la tapa del resorte de la válvula. Asimismo, compruebe si la fuerza del resorte de la válvula se encuentra dentro de los valores indicados por el fabricante del motor.



En el montaje de las válvulas siempre utilice trabas o chavetas y retenes nuevos.

Antes de su introducción en la guía, el vástago de la válvula debe lubricarse lo suficiente con aceite nuevo para motor.

Dimensiones

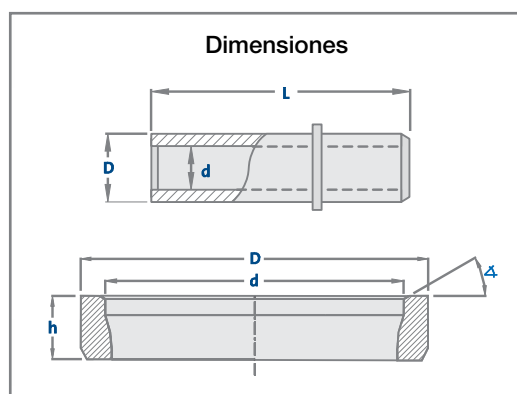
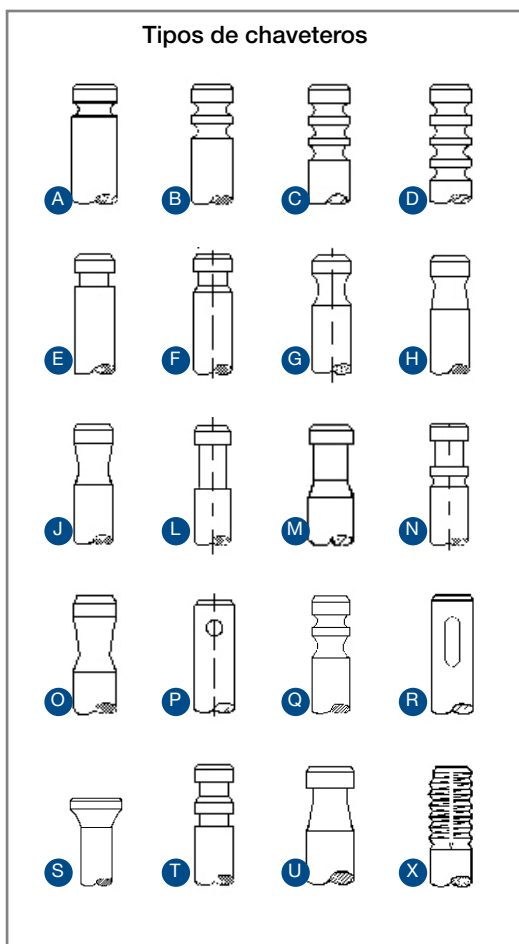
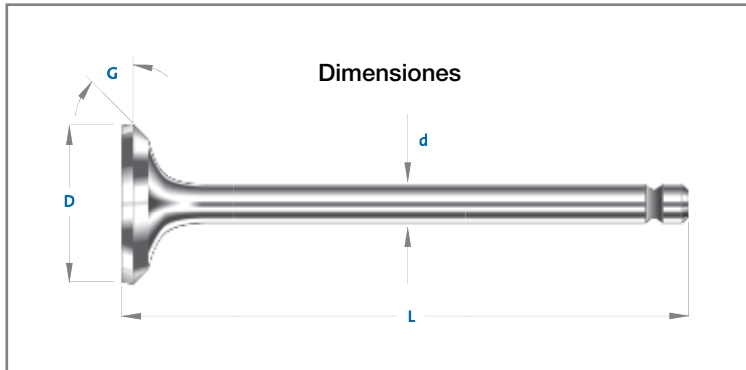

Configuración de las páginas y códigos de artículos

1 MERCEDES-BENZ						MAHLE		
2	3	4	5	6	7	8	9	
								Nº CIL.
Mot. OM 447 LA/449 LA Motor Maxion Sprinter 2.5l.	5/6	IN - EX	GC0480030	STD	18,04 x 12,00 x 67,00	FG	A-2	
	4	IN - EX	GC0570056	STD	14,05 x 8,01 x 49,00 0,1 14,15 x 8,01 x 49,00	FG	F	
Motor OM 321 L1112-LS1112-LO1112	6	IN	GA0480007	STD	15,04 x 9,00 x 78,00	FG	A-3	
Motor OM 352, OM 352A, OM 314 Con Cámara Interior	6	IN	GA0480007	STD	15,04 x 9,00 x 78,00	FG	A-3	
Motor OM 352, OM 352A, OM 314-1114 (mod.'84 en ad.)	6	EX	GE0480026	STD	15,04 x 10,00 x 67,00	FG	A	
Motor OM 352, OM 352A, OM 314A/ Turbo L508D-L608D-L1113-L1114-L1413-LK1517	6	IN	GA0480007	STD	15,04 x 9,00 x 78,00	FG	A-3	
		EX	GE0480031	STD	15,03 x 10,00 x 73,00	FG	A	
Motor OM 355 L1521-L1526, OM 346, OM 355 Turbo	5/6	IN	GA0480013	STD	15,04 x 9,01 x 67,50	FG	A-1	
		EX	GE0480014	STD	15,04 x 9,01 x 86,50	FG	A-1	
Motor OM 366, OM 366 Turbo	6	IN	GA0480033	STD	15,04 x 9,00 x 72,00	FG	A-1	
		EX	GE0480035	STD	15,04 x 10,00 x 67,00	FG	A-2	
				STD	15,09 x 10,00 x 67,00	FG	A-1	
Motor OM 447, OM 449 1633	6	IN - EX	GC0480030	STD	18,04 x 12,00 x 67,00	FG	A-2	
Motor OM 457 LA	6	IN - EX	GC0480053	STD	15,04 x 9,00 x 61,10	FG	F-1	
Motor OM 904LA 12v., OM 906LA 712, 1721 18v.	4/6	IN - EX	GC0480068	STD	14,04 x 8,00 x 60,00	FG	P	
Motores OM 352 e 321	6	IN	GA0480007	STD	15,04 x 9,00 x 78,00	FG	A-3	
Motores OM 352A c/ quebra carvão-Mercedes Benz	6	EX	GE0480044	STD	15,04 x 10,01 x 67,00	-	A-6	
Motores OM 366, OM 352A- Mercedes Benz	6	IN	GA0480001	STD	15,03 x 9,01 x 72,00	-	A-1	
		EX	GE0480002	STD	15,03 x 10,01 x 67,00	-		

1 Fabricante

2 Descripción del motor
Datos del motor
Vehículos
Año de construcción

3 Número de cilindros

4 Función
IN = Admisión
EX = Escape
IN - EX = Común

5 Medidas de la válvula en mm

6 Materiales de la válvula/Revestimiento de la válvula

Ej.: A/M/ST/CP

Revestimiento
Material de construcción

7 Asiento bonificado de la válvula/Ángulo del asiento de la válvula



8 Modelo de acabado del vástago

9 Forma de la cabeza



10 Número de artículo de la válvula

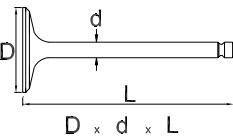
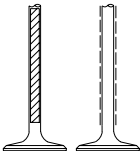
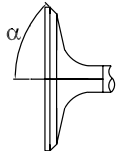

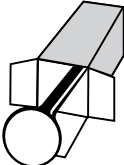
Ex.: VA0250002

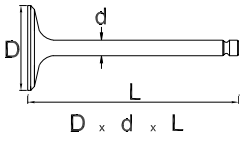
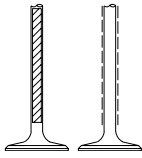
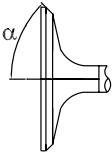
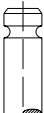

Número secuencial
Línea motora

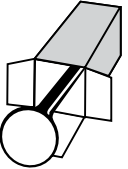

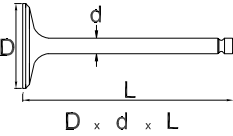
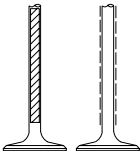
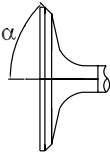
	Nº CIL.	TIPO TYPE						
Motor M70 / M73	1	IN - EX	30.30 x 6.95 x 74.80	M	45°	A	A	VC0060905*
Motor M80 - Diesel	1	IN	34.10 x 7.95 x 121.55	M	45°	L	A	VA0060902*
		EX	31.00 x 7.95 x 121.45	M	45°	L	A	VE0060906*
Motor M85 / 90 / 93 - Trator 4100 - Diesel	1	IN	41.05 x 7.96 x 120.85	M	45°	L	A	VA0060903*
		EX	35.00 x 7.95 x 121.40	M	45°	L	A	VE0060323*
Motor M790 - Trator T440, 4200 - Diesel	2	IN	39.10 x 8.95 x 131.95	M	45°	A	A	VA0060904
		EX	35.00 x 8.95 x 131.95	M	45°	A	A	VE0060907

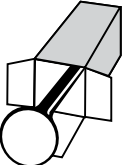
(*) Item sob consulta

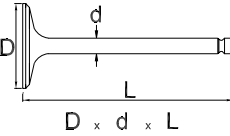
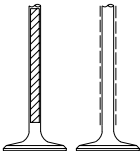
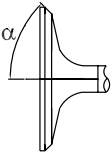

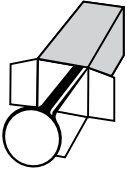
	N° CIL.	TIPO TYPE						
Motor 1.6i / 1.8i / 2.0i 16v AR67203 - Alfa 145, 146, 155, 156 TS	4	IN	33.55 x 6.98 x 113.36	M/CP	45°30'	C	A	VA0250168
		EX	28.10 x 6.96 x 108.49	A/CP/M/ST	45°30'	C	A	VE0250169

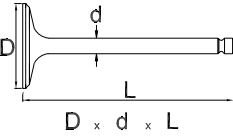
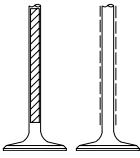
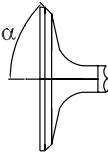

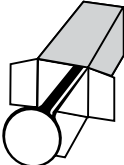
	Nº CIL.	TIPO TYPE						
Motor 800cc - Towner - Gasolina	3	IN EX	36.00 x 6.94 x 101.78 33.00 x 6.94 x 101.70	CS A/CP/M	45° 45°	A A	C E	VA0720156 VE0720157
Motor 2.7 - Topic - Diesel	4	IN EX	40.50 x 7.94 x 114.60 36.10 x 7.92 x 114.90	M/N A/M/N	45° 60°	A A	C E	VA0720154 VE0720155

	Nº CIL.	TIPO TYPE						
Motor 1.8 20v AGN Aspirado - Audi A3, A4 - Gasolina	4	IN	27.00 x 5.97 x 105.00	M/ST	45°15'	C	C	VA0700242
Motor 1.8 20v AGU Turbo - Audi A3, A4 - Gasolina	4	IN	27.00 x 5.97 x 105.00	M/ST	45°15'	C	C	VA0700242
		EX	29.90 x 5.95 x 104.00	AB/M/ST/CP	45°15'	C	A	VE0700243

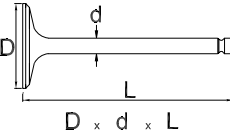
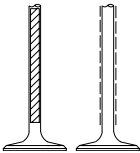
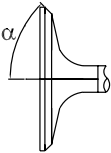

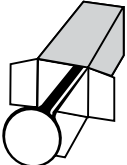
	Nº CIL.	TIPO TYPE						
Motor 1.8 16v - 318i / Motor 2.5 24v - 323i, 325i, 525i - Gasolina	4-6	IN	32.87 x 5.97 x 106.10	M/CP/SH	44°30'	C	A	VA1401226*
		EX	30.30 x 5.95 x 105.70	A/M/CP	44°30'	C	A	VE1400820*

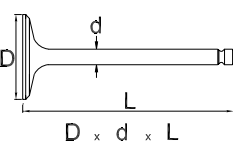
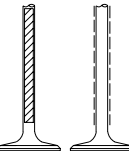
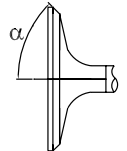

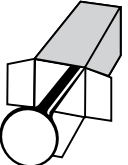
(*) Item sob consulta

	Nº CIL.	TIPO TYPE						
Motor Série 30 Genesis - Aspirado / Turbo	4-6	IN	46.60 x 9.44 x 145.90	A/M/CP	29°30'	D	E	VA1961403
		EX	43.00 x 9.41 x 146.44	A/M/CP	44°30'	D	E	VE1961404

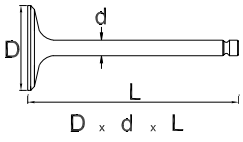
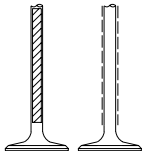
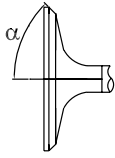
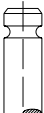

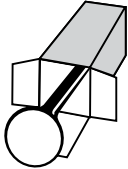
	Nº CIL.	TIPO TYPE						
Cilindro 5.75 pol. (Ø 146,1 mm) 2v/Cil.	4-6	IN	59.50 x 12.60 x 236.09	AN/CS	45°45'	J	A	VA0110140
		EX	57.96 x 12.60 x 235.30	AN/CS	45°45'	J	A	VE0110141
Motor D330C, D333C, 1673C, 3304, 3306 - Aspirado	4-6	IN	51.30 x 9.43 x 139.91	M	60°45'	B	C	VA0110143
		EX	48.10 x 9.43 x 138.92	M	60°45'	B	C	VE0110142
Motor D330C, D333C, 1673C, 3304, 3306 - Turbo	4-6	EX	48.10 x 9.43 x 139.13	AN/CS/ST	60°45'	B	C	VE0110144
Motor 3046	4	IN	44.00 x 7.96 x 120.00	A/N	60°15'	E	E	VA0111415
		EX	35.00 x 7.94 x 120.00	A/N	60°15'	E	E	VE0111416
Motor 3056E - Série 356	4-6	IN	43.00 x 8.97 x 122.85	A/M/CP	60°	A	C	VA0111407
		EX	41.00 x 8.97 x 122.85	A/M/CP	60°	A	C	VE0111408
Motor 3064 / 3066	4-6	IN	44.00 x 7.96 x 134.00	A/N	60°	E	A	VA0111409
		EX	37.00 x 7.95 x 134.00	A/N	60°	E	A	VE0111410
Motor 3114 4400cc - 924F / Motor 3116 6600cc Turbo - 960F, 950F, 325, 325L - Chevrolet Kodiak	4-6	IN	47.00 x 8.00 x 177.18	A/M	60°45'	A	C	VA0110232
		EX	40.00 x 8.00 x 176.72	AN/CS/ST/CP	45°15'	A	C	VE0110233
Motor 3114 / 3116 - C9	6	IN	36.00 x 9.45 x 184.50	AN/CS/CP	Eatonite 65°45'	B	C	VA0111411
		EX	36.00 x 9.45 x 183.00	CS/X/CP	45°45'	C	C	VE0111412
Motor 3208	8	IN	53.20 x 9.46 x 144.78	M	60°15'	B	E	VA0110235*
		EX	45.74 x 9.44 x 144.35	A/M	45°15'	B	C	VE0110234*
Motor 3304 - 120G, 130G, 140G, D4E / Motor 3306 - 814B, 815B, 816B, 235, 14G, 12G, D6D	4-6	EX	47.98 x 9.44 x 134.75	AN/CS/ST	60°45'	B	C	VE0110146
Motor 3304NA Injeção Direta - D4E / Motor 3306 - D5B, 12G, 561D	4-6	IN	51.28 x 9.44 x 136.35	M	60°45'	B	A	VA0110145
		EX	47.98 x 9.44 x 134.75	M	29°30'	B	A	VE0111243
Motor 3304NA (Com pré-câmara) - D4D, D5	4-6	IN	51.30 x 9.43 x 139.91	M	60°45'	B	C	VA0110143
Motor 3306NA (Com pré-câmara) - D6C, D7E	4-6	EX	48.10 x 9.43 x 138.92	M	60°45'	B	C	VE0110142
Motor 3306TC (Com pré-câmara) - D6C, D7E	4-6	EX	48.10 x 9.43 x 139.13	AN/CS/ST	60°45'	B	C	VE0110144
Motor 3306TC Injeção Direta - D6D, D6E, D6E SR, D5E (Turbo Opcional), 330, 330L, 140G / Motor 3306 - 814B, 815B, 816B, 235, 14G, 12G, D6D	4-6	EX	47.98 x 9.44 x 134.75	AN/CS/ST	60°45'	B	C	VE0110146
Motor 3508 / 3512	8-12	IN	56.00 x 9.45 x 219.00	M/CP	71°	B	C	VA0111413
		EX	56.00 x 12.58 x 219.00	AN/CS/CP	Eatonite 45°36'	E	C	VE0111414

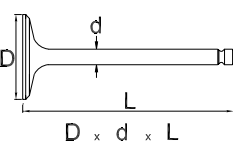
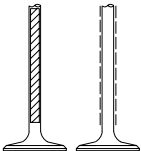
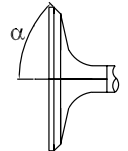
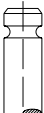
(*) Item sob consulta

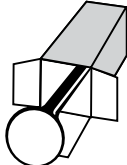

	N° CIL.	TIPO TYPE						
Motor 1.1 16v Acteco (SQR472F) - Chery QQ - 2011-> - Gasolina	4	IN	24.50 x 4.97 x 78.28	M/N	45°30'	A	C	VA3481577
		EX	21.00 x 4.96 x 78.89	A/N	45°30'	A	C	VE3481578

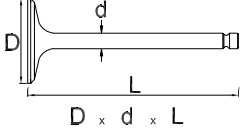
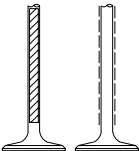
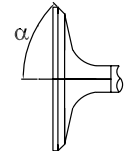

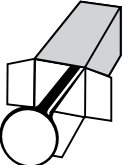
	N° CIL.	TIPO TYPE						
Motor 1.0 8v - TU9K, TU9M, TU9A - 106, 205, Audace, Escape, AX10E, Saxo - Gasolina	4	IN	34.70 x 6.97 x 112.77	M	30°	A	C	VA0440572
		EX	27.80 x 6.97 x 112.60	A/M/CP	45°	A	C	VE0440593
Motor 1.3 / 1.4 TU3FJ2K - Saxo, Xsara / Motor 1.4 TU5J2 - 106, 206, 306 / Motor 1.6 TU5JP - Gasolina	4	IN	39.30 x 6.97 x 111.50	M/SH	30°	C	C	VA0440575
		EX	31.35 x 6.97 x 111.75	A/M/CP	45°	C	C	VE0440596
Motor 1.4 8v - C2, C3 - Flex	4	IN	36.66 x 6.98 x 112.70	M/CP	45°	A	C	VA0441091
		EX	29.15 x 6.98 x 112.57	M/CP	45°	A	C	VE0440588
Motor 1.5 8v TU4M - Aircross, C3 Picasso, C3 - Flex	4	IN	37.65 x 5.98 x 112.31	M	Stellite 45°	A	C	VA0441689*
		EX	30.20 x 5.96 x 112.61	A/M	Stellite 45°	A	C	VE0441690*
Motor 1.6 16v TU5JP4 - 206, C3, Picasso, 307 - Gasolina	4	IN	31.30 x 5.98 x 103.80	M	45°	A	C	VA0440578
			24.50 x 5.96 x 104.40	A/M/CP	45°	A	E	VE0440598
Motor 1.6 16v TU5JP4 Aspirado - 2008, 206, 207, 208, 307, 308, Hoggar, Partner, Aircross, C3, C4, Xsara - Flex	4	IN	31.30 x 5.98 x 103.80	M	45°	A	E	VA0441701
		EX	24.50 x 5.96 x 104.40	A/M	45°	A	E	VE0441702
Motor 1.6 16v / 1.9 16v - Visa GT, GTI BX19TRS - Gasolina	4	IN	41.58 x 7.97 x 108.74	M/SH	44°50'	A	A	VA0440551
		EX	34.48 x 7.97 x 108.32	A/M/CP	44°22'	A	A	VE0440585
Motor 1.8 16v XU7JP4 - Xantia, Xsara - Gasolina	4	IN	34.60 x 6.98 x 106.40	M/SH	44°30'	C	C	VA0440571
		EX	29.50 x 6.98 x 105.77	A/M/CP	44°30'	C	C	VE0440590
Motor 2.0 16v EW10A - C4, C4 Pallas - 2008-> - Gasolina / Flex	4	IN	33.20 x 5.97 x 106.20	M/SH	44°30'	A	C	VA0440579
		EX	29.07 x 5.96 x 103.60	A/M/ST/CP	44°30'	A	A	VE0441603 (VE0440599)
Motor 2.0 16v EW10J4 - Picasso	4	IN	33.20 x 5.97 x 106.20	M/SH	44°30'	A	C	VA0440579
		EX	29.07 x 5.96 x 103.60	A/M/ST/CP	44°30'	A	A	VE0441603 (VE0440599)
Motor 2.8 Aspirado - Jumper - Diesel	4	IN	43.35 x 7.99 x 121.80	AB/M/CP	60°	A	C	VA0250513
		EX	35.90 x 7.99 x 121.95	A/M/CP	44°30'	A	A	VE0010212

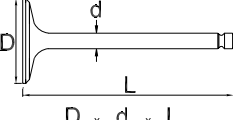
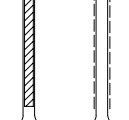
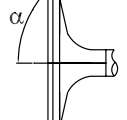

(*) Item sob consulta

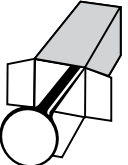
	Nº CIL.	TIPO TYPE						
Motor B 5.9L / BTA 5.9L / BTAA 5.9L	4-6	IN	44.98 x 7.97 x 129.05	M/CP	30°	A	A	VA0210151
		EX	42.03 x 7.96 x 128.96	A/CP	45°	A	A	VE0210150
Motor ISB 4.5L / 6.7L Euro 5 - Ford Cargo	4-6	IN	33.00 x 7.00 x 124.65	M/CP	30°	A	C	VA0210442
		EX	33.00 x 7.00 x 124.28	A/M/CP	45°	A	C	VE0210443
Motor ISM, QSM, L10, M11 Eletrônico	6	IN	42.55 x 9.63 x 195.45	M	30°	A	C	VA0210237
		EX	42.42 x 9.62 x 195.45	A/M/ST/CP	30°	A	C	VE0210236
Motor ISF 2.8 16v - F350, F4000, Delivery 4150, 6160 - 2014-> - Diesel	4	IN	32.65 x 6.10 x 106.00	M/LCP	60°	A	C	VA0211732*
		EX	29.00 x 6.10 x 105.65	A/M/LCP	45°	A	C	VE0211733*
Motor L10 Mecânico	6	IN	42.38 x 9.63 x 176.35	M/CP	30°	A	C	VA0210446
		EX	42.43 x 9.63 x 176.30	AN/CS/ST/CP	30°	A	C	VE0211261
Motor C 8.3L / CT 8.3L / CTA 8.3L / CTAA 8.3L	6	IN	52.00 x 9.49 x 151.18	M/CP	60°	A	A	VA0210153
		EX	46.06 x 9.49 x 150.94	A/M/CP	45°	A	A	VE0210152
Motor Série C Eletrônico	6	IN	38.00 x 7.98 x 137.75	A/M/CP	60°	A	C	VA0211427
		EX	38.00 x 7.98 x 137.77	A/M/CP	45°	A	C	VE0211428
Motor 505 CI, Serie ISC Turbo 8.3L 24v	6	IN	38.00 x 7.98 x 137.76	M/CP	30°	A	A	VA0211371
		EX	38.03 x 7.97 x 137.73	A/M/CP	45°	A	A	VE0211372
Motor N855 / NT855 / NTA855 / NH-NHE 220 / 225 / 230 / 250 / NHCT / NTA 370 / 380 / 420	6-12	IN	47.60 x 11.43 x 179.30	M/SH	30°	B	A	VA0210147
Motor NTA855 / NTA855 - (Big Cam) - Marítimo	6-12	EX	47.50 x 11.46 x 179.42	AN/CS	60°	B	A	VE0210148
		EX	47.50 x 11.46 x 179.42	A/CS	60°	B	A	VE0210149
Motor G5.9 / B4.5 / QSB5.9 / ISBe / GB / B5.9 / QSB4.5 / QSB3.9 - Turbo Eletrônico Ecológico	4-6	IN	33.00 x 7.00 x 124.65	M/CP	30°	A	C	VA0210442
		EX	33.00 x 7.00 x 124.28	A/M/CP	45°	A	C	VE0210443
Motor ISF 3.8 8V / 16v SOHV L4 Euro 5 - Delivery 5150, 8160, 9150, 10160 Pus, Agrale Chassi MA 8.7	4	IN	33.00 x 7.00 x 124.65	M/CP	30°	A	C	VA0210442
		EX	33.00 x 7.00 x 124.28	A/M/CP	45°	A	C	VE0210443
Motor ISL 8.9L 24v - Constellation 19330 Tractor	6	IN	38.00 x 7.98 x 137.76	M/CP	30°	A	A	VA0211371
		EX	38.03 x 7.97 x 137.73	A/M/CP	45°	A	A	VE0211372
Motor Série K	6	IN	56.32 x 12.58 x 191.75	M/CP	60°	E	E	VA0211465
		EX	56.41 x 12.56 x 191.76	AN/CS/ST/CP	60°	E	E	VE0211466

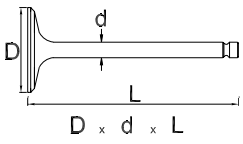
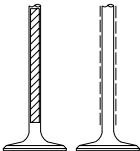
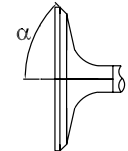

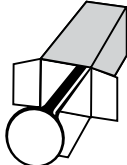
(*) Item sob consulta

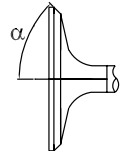

	N° CIL.	TIPO TYPE						
147, Uno, Spazio, Vivace, Duna Motor Tipo 1400-1600cc. 1378N (Gasolina)	4	EX	31.00 x 7.98 x 109.00	A/ST/CP	44°30'	A	A	VE0250053
127,147, Spazio, Vivace, Uno, Duna, Fiorino (1100-1300)	4	IN	36.00 x 7.98 x 108.50	M/CP	45°30'	A	A	VA0250060
		EX	33.13 x 7.98 x 108.95	A/CP/ST	Stellite 44°30'	A	A	VE0250059
128, 147, Spazio, Vivace, Uno, Duna, Fiorino (1100-1300)	4	IN	36.00 x 7.98 x 108.50	M/CP	45°30'	A	A	VA0250060
		EX	31.00 x 7.98 x 109.00	A/ST/CP	44°30'	A	A	VE0250053
Motor 1.0 / 1.050 / 1.3 / 1.5 - Carburado / 1 bico - 147, Uno, Prêmio, Elba - Gasolina / Álcool	4	IN	34.03 x 7.97 x 110.15	A/M/CP	44°30'	A	A	VA0250002
		EX	28.98 x 7.98 x 110.60	A/CP	44°30'	A	A	VE0250001
Motor 2.0 20v 5cil Aspirado - Marea - Gasolina	4	IN	30.00 x 6.98 x 113.15	A/M/CP	45°30'	D	A	VA0250160
		EX	26.10 x 6.97 x 108.58	A/CP/M/ST	45°30'	D	A	VE0250161
Motor 1.0 MPI / 1.5 MPI - Palio, Palio Weekend - Gasolina	4	IN	36.45 x 7.98 x 110.20	M/CP	45°	A	A	VA0250018
		EX	29.40 x 7.98 x 110.60	A/CP	Stellite 44°30'	A	A	VE0250019
Motor 1.0 16v Fire / 1.3 16v Fire - Doblo, Palio, Siena, Strada - Gasolina	4	IN	26.90 x 5.99 x 95.20	M/CP/SH	44°30'	C	C	VA0250166
		EX	22.40 x 5.98 x 96.18	AB/M/ST	45°	C	A	VE0250163
Motor 1.0 8v Fire / 1.3 8v Fire - Fiorino, Palio, Weekend, Siena, Strada, Uno Mille - Até 2008 - Gasolina / Flex	4	IN	31.40 x 6.99 x 97.00	M/CP/SH	45°50'	A	C	VA0250162
		EX	27.35 x 6.99 x 97.20	A/ST/CP	44°30'	A	A	VE0250167
Motor 1.0 8v Fire Economy - 2009-> - Flex / Motor 1.0 8v Evotec - 2010-> - Flex / Motor 1.0 8v Fire - Mobi - 2016-> - Flex / Motor 1.3 8v Economy - Flex	4	IN	31.40 x 4.99 x 98.10	M/CP	44°30'	C	C	VA0251632
			27.30 x 4.98 x 98.77	A/M/CP	44°45'	C	C	VE0250272
Motor 1.4 8v Fire - Palio, Idea, Siena - 2006-> - Flex	4	IN	33.18 x 4.99 x 98.20	M/CP	44°45'	C	C	VA0250271
		EX	27.30 x 4.98 x 98.77	A/M/CP	44°45'	C	C	VE0250272
Motor 1.4 8v Evotec - 2011-> - Flex	4	IN	33.20 x 4.99 x 99.90	M/CP	44°30'	C	C	VA0251633
		EX	28.00 x 4.99 x 100.46	A/M/CP	45°30'	C	C	VE0251476
Motor 1.5 - 128	4	IN	36.00 x 7.98 x 108.50	M/CP	45°30'	A	A	VA0250060
Motor 1.5 Sevel Argentino - 85cv - Gasolina / Álcool	4	IN	39.50 x 7.98 x 108.50	CP/M	44°30'	A	A	VA0250054
		EX	31.00 x 7.98 x 109.00	A/CP/ST	Stellite 44°30'	A	A	VE0250053
Motor 1.5 Sevel Argentino - 70cv a 82cv - Uno, Premio, Elba, Fiorino	4	IN	36.00 x 7.98 x 108.50	M/CP	45°30'	A	A	VA0250060
		EX	33.13 x 7.98 x 108.95	A/CP/ST	Stellite 44°30'	A	A	VE0250059
Motor 1.6 8v Carburado / 1 bico - Uno, Premio, Duna, Elba, Fiorino, Palio / Motor 1.6 8v IE / MPI - Tipo	4	IN	39.50 x 7.98 x 108.50	CP/M	44°30'	A	A	VA0250054
		EX	31.00 x 7.98 x 109.00	A/CP/ST	Stellite 44°30'	A	A	VE0250053
Motor 1.6 16v - Marea, Palio, Siena - Gasolina	4	IN	30.40 x 6.99 x 102.50	M/CP	44°30'	A	C	VA0250165
		EX	29.90 x 6.99 x 102.35	A/CP/ST	45°30'	A	C	VE0250164
Motor 1.8 16v - Marea, Stilo, Brava - Gasolina	4	IN	33.55 x 6.98 x 113.36	M/CP	45°30'	C	A	VA0250168
		EX	28.10 x 6.96 x 108.49	A/CP/M/ST	45°30'	C	A	VE0250169
Motor 1.6 16v Etorq / 1.8 16v Etorq - Bravo, Doblo, Idea, Linea, Palio, Punto, Siena, Strada - Flex	4	IN	30.77 x 5.94 x 109.52	M/CP	44°30'	C	C	VA0251610
		EX	23.27 x 5.92 x 118.34	AB/M/N	44°30'	C	E	VE0251611

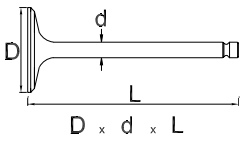
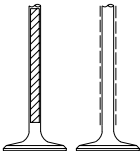
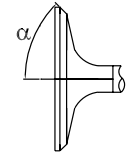

	N° CIL.	TIPO TYPE						
Motor 1.8 8v - Palio (EX, ELX, HLX) 2003->2007, Palio Weekend (EX, ELX, HLX, Stile, Adventure) 2003->2006, Strada (Working, Trekking, Adventure) 2003->2008, Siena (EX, ELX, HLX) 2003->2007 - Gasolina	4	IN	38.00 x 7.00 x 101.50	M/CP	44°	A	C	VA0140086
		EX	31.00 x 6.99 x 101.50	A/ST/CP	44°	A	E	VE0140370
Motor 1.8 8v - Palio (R, ELX, HLX) 2006->2010, Palio Weekend (HLX, Trekking, Adventure) 2006->2010, Strada (Trekking, Adventure) 2006->2012, Siena (HLX) 2006->2010, Doblo, Stilo Até 2011 - Flex	4	IN	37.96 x 5.97 x 101.63	M/CP/SH	44°	C	C	VA0251614
		EX	31.05 x 5.94 x 101.56	A/M/N	44°	C	C	VE0251615
Motor 2.0 8v Injeção - Tempra, Tempra SW, Tipo - Gasolina / Álcool	4	IN	43.50 x 7.98 x 105.52	A/CP	45°30'	A	C	VA0250159
		EX	36.15 x 7.98 x 105.95	A/CP/M	45°30'	A	A	VE0250158
Motor 2.0 16v - Tempra, Tipo - Gasolina	4	IN	34.50 x 7.00 x 127.93	A/M/ST/CP	45°30'	A	A	VA0250052
		EX	28.38 x 6.98 x 125.55	A/CP/M/ST	45°50'	A	C	VE0250051
Motor 2.4 20v Aspirado - Marea - Gasolina	4	IN	33.55 x 6.98 x 113.36	M/CP	45°30'	C	A	VA0250168
		EX	28.10 x 6.96 x 108.49	A/CP/M/ST	45°30'	C	A	VE0250169
Motor 2.8 Aspirado - Ducato - Diesel	4	IN	43.35 x 7.99 x 121.80	AB/M/CP	60°	A	C	VA0250513
		EX	35.90 x 7.99 x 121.95	A/M/CP	44°30'	A	A	VE0010212

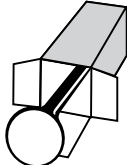

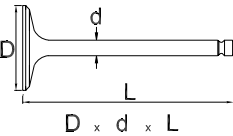
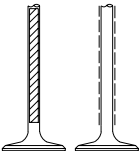
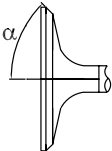
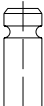
	Nº CIL.	TIPO TYPE						
Motor B 5.9L / BTA 5.9L / BTAA 5.9L - C1215, C1415, C1617	4-6	IN	44.98 x 7.97 x 129.05	M/CP	30°	A	A	VA0210151
		EX	42.03 x 7.96 x 128.96	A/CP	45°	A	A	VE0210150
Motor C 8.3L / CT 8.3L / CTA 8.3L / CTAA 8.3L - C1422, C1622, C2422, C3224, C3530	6	IN	52.00 x 9.49 x 151.18	M/CP	60°	A	A	VA0210153
		EX	46.06 x 9.49 x 150.94	A/M/CP	45°	A	A	VE0210152
Motor 1.0 AE / 1.3 CHT / 1.6 CHT / 1.6 AE - Corcel, Escort, Verona - Gasolina / Álcool	4	IN	32.40 x 6.97 x 96.50	CP/M	45°	L	C	VA0590043
		EX	28.32 x 6.97 x 96.20	A/ST/CP	44°52'	L	C	VE0590042
Motor 1.0 8v Endura Nacional / Espanhol - Fiesta - Gasolina	4	IN	33.00 x 7.03 x 104.05	M/CP	45°	C	C	VA0590181
Motor 1.0 8v / 1.3 8v - Endura Nacional / Espanhol - Fiesta, Ká - Jan/1997->Mai/1999 - Gasolina	4	EX	28.87 x 7.01 x 104.35	A/CP/M/ST	44°52'	C	C	VE0590173
Motor 1.0 8v Zetec Rocan - Ká, Courier, Fiesta - Gasolina	4	IN	32.45 x 5.98 x 111.10	M/CP	45°	C	C	VA0590170
		EX	28.10 x 5.96 x 110.65	A/M/CP/ST	45°	C	C	VE0590171
Motor 1.0 8v Zetec Rocan - Ká, Courier, Fiesta - Flex	4	IN	32.45 x 5.97 x 111.14	M/N	45°	C	C	VA0591474
		EX	28.10 x 5.96 x 110.65	A/M/CP/ST	45°	C	C	VE0590171
Motor 1.0 12v - Ká, Ká + - 2014-> - Flex	3	IN	27.20 x 4.96 x 96.20	M/N	45°	C	C	VA0591722*
		EX	22.95 x 4.95 x 98.50	AB/N	60°30'	C	C	VE0591723*
Motor 1.1 HCS - Escort	4	IN	33.00 x 7.03 x 104.05	M/CP	45°	C	C	VA0590181
		EX	28.87 x 7.01 x 104.35	A/CP/M/ST	44°52'	C	C	VE0590173
Motor 1.3 8v Endura Nacional / Espanhol - Fiesta, Courier - Gasolina	4	IN	34.35 x 7.04 x 104.10	M/CP	45°	C	C	VA0590172
Motor 1.4 16v Zetec - Courier, Fiesta - Gasolina	4	IN	28.10 x 5.96 x 97.35	M/CP/SH	45°30'	C	C	VA0590179
		EX	24.15 x 5.96 x 99.40	A/N	45°30'	C	E	VE0590178
Motor 1.4 - Gasolina / Álcool / Motor 1.6 - Corcel I / II - Álcool	4	IN	32.37 x 6.97 x 89.65	M	45°	L	C	VA0590093
Motor 1.4 / 1.6 - Corcel II, Belina I / II - Gasolina / Álcool	4	EX	28.40 x 7.00 x 89.40	A/M	45°	L	C	VE0590092
Motor 1.5 16v Sigma - New Fiesta, Ká e Ká+ / 1.6 16v Sigma - New Fiesta, Focus, EcoSport - Flex	4	IN	30.10 x 5.97 x 99.00	M/N	44°30'	C	C	VA0591471
		EX	24.10 x 5.96 x 101.40	AB/N	44°30'	C	C	VE0591472
Motor 1.6 AP / 1.8 AP - Injeção - Galaxy, Escort, Orion - Gasolina - Tucho Hidráulico	4	IN	38.00 x 7.96 x 91.40	M/SH	44°30'	C	C	VA0590066
		EX	33.00 x 7.94 x 90.80	A/M/ST	Stellite 45°10'	C	A	VE0590065
Motor 1.6 - Corcel II, Belina II - Gasolina	4	IN	37.90 x 7.00 x 89.70	M	45°15'	L	C	VA0590094
Motor 1.6 CHT / 1.6 AE - Corcel, Escort, Verona - Out/1982->Dez/1996 - Gasolina	4	IN	36.38 x 6.98 x 97.02	CP/M	45°	L	C	VA0590044
Motor 1.6 8v Zetec Rocan - Courier, EcoSport, Fiesta, Focus, Ká - Gasolina	4	IN	40.00 x 5.97 x 109.50	CS/CP	45°30'	C	C	VA0590174
		EX	34.00 x 5.96 x 109.86	A/M/CP/ST	45°15'	C	C	VE0590175
Motor 1.6 8v Zetec Rocan - Courier, EcoSport, Fiesta, Focus, Ká - Flex	4	IN	39.92 x 4.96 x 109.62	M/CP	45°	C	C	VA0591473
		EX	34.00 x 5.96 x 109.86	A/M/CP/ST	45°15'	C	C	VE0590175
Motor 1.8 AP Carburado / Injeção - Del Rey, Belina, Escort, Verona, Versailles, Royale - 1993->1997 - Gasolina / Álcool	4	IN	38.00 x 7.96 x 91.40	M/SH	44°30'	C	C	VA0590066
		EX	33.00 x 7.94 x 90.80	A/M/ST	Stellite 45°10'	C	A	VE0590065
Motor 1.8 16v Zetec / 2.0 16v Zetec - Escort, Focus, Mondeo - Gasolina	4	IN	31.95 x 6.04 x 97.10	M/CP/SH	45°30'	C	A	VA0590180
		EX	27.95 x 6.02 x 96.70	AB/M/CP	45°	C	C	VE0590182

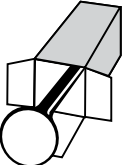

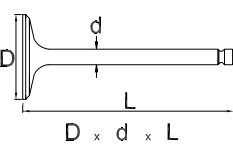
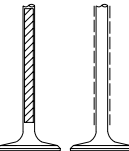
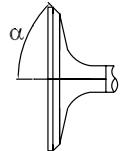
(*) Item sob consulta

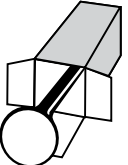
	Nº CIL.	TIPO TYPE						
Motor 2.0 16v Duratec HE - EcoSport, Focus, Mondeo, Ranger - Gasolina / Flex / Motor 2.3 16v - Fusion, Ranger - Gasolina	4	IN	35.00 x 5.48 x 103.40	M/CP	45°15'	A	C	VA0590255
			30.00 x 5.48 x 104.60	A/CP	45°15'	A	C	VE0590256
Motor 2.0 AP Carburado / Injeção - 1991->1997 - Gasolina / Álcool	4	IN	39.98 x 7.96 x 98.70	M/SH	Stellite 45°15'	C	E	VA0590067
		EX	33.00 x 7.94 x 90.80	A/M/ST	Stellite 45°10'	C	A	VE0590065
Motor 2.0 AP Injeção - Galaxy, Escort XR3 - Gasolina - Tucho Hidráulico	4	EX	33.00 x 7.94 x 90.80	A/M/ST	Stellite 45°10'	C	A	VE0590065
Motor 2.5 MPI - Ranger - Gasolina	4	IN	44.07 x 6.98 x 121.60	M/CP	45°	C	C	VA0591461
		EX	38.14 x 6.96 x 122.05	A/CP	45°	C	C	VE0591462
Motor 2.8L HSTD Power Stroke - Ranger - Diesel	4	IN	38.95 x 7.97 x 116.38	A/M/CP	30°	C	A	VA0570250
		EX	36.50 x 7.97 x 116.38	A/M/CP	45°	C	A	VE0570230
Motor 3.0 16v HS TDI Motor International NGD - Ranger, Troller	4	IN	32.00 x 5.94 x 114.19	M/CP	45°	C	C	VA0570231
		EX	29.00 x 5.93 x 114.20	AB/M/CP	45°	C	C	VE0570232
Motor 4.0 V6 EFI 244cv - Ranger, Explorer - Até 2001 - Gasolina	6	IN	43.50 x 8.04 x 103.85	M	45°52'	C	C	VA0590275
	6	EX	34.56 x 8.01 x 104.13	A/M/CP	44°30'	C	C	VE0590276
Motor 4.0 V6 244cv - Ranger, Explorer - 2001-> - Gasolina	6	IN	46.00 x 7.00 x 114.90	M	45°20'	C	C	VA0590221
		EX	39.00 x 7.00 x 114.90	A/N	45°20'	C	C	VE0590222
Motor D229 - F1000, F2000, F4000, F7000, F11000, F12000, F13000, F14000, F19000, F21000 - Diesel	3-4-6	IN	40.98 x 8.96 x 116.95	CP/M	44°30'	C	A	VA0130011
	6	EX	37.98 x 8.96 x 116.95	CP/M	44°45'	C	A	VE0130010
Motor 6357 - Injeção Indireta - F700, F750 - Até 1968 / F11000 - Até 1982	4-6	IN	46.89 x 9.47 x 132.40	CS	45°	A	A	VA0570033
		EX	40.50 x 9.45 x 132.36	M	45°15'	A	C	VE0570034
Motor 6358 - Injeção Direta - F700, F750 1968->1972, F11000, F12000, F13000	6-8	IN	45.22 x 9.47 x 139.45	A/CP	45°	A	A	VA0570111
		EX	38.88 x 9.46 x 139.75	A/ST/CP	45°	A	A	VE0570112

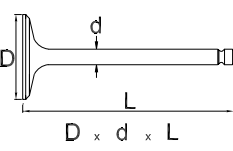
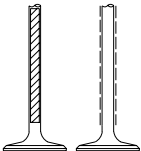
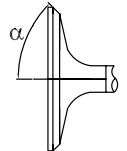
	Nº CIL.	TIPO TYPE						
Motor 2600 e 3000 - Jeep, Rural, Pick up - 1965->	4	IN	44.50 x 9.50 x 115.20	M	45°	L	C	VA0230119
		EX	35.88 x 8.63 x 117.10	A	45°	E	E	VE0230118

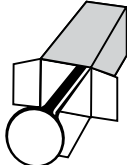

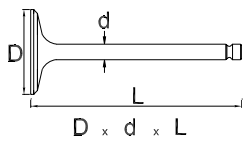
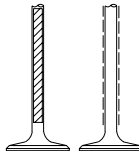
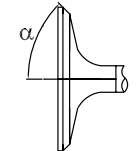
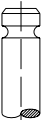
	Nº CIL.	TIPO TYPE						
Motor 151 - Opala, Caravan - 1974->1992 / Motor 153 - 1969->1973 / Motor 230 - 1969->1971	4-6	IN	43.70 x 8.67 x 124.80	M	45°	T	E	VA0140104
Motor 151 - Opala, Caravan - 1974->1979 / Motor 153 - 1969->1973 / Motor 230 - 1969->1971	4-6	IN	43.70 x 8.75 x 124.80	M	45°	T	E	VA0140108
		IN	43.70 x 9.05 x 124.80	M	45°	T	E	VA0140110
Motor 194 / 230 / 234 / 236 / 250G - 1962->1978 / Motor 262 / 267 / 292 / 305 / 327 - 1963->1987 / Motor 250 / 250S	6-8	IN	43.70 x 8.67 x 124.80	M	45°	T	E	VA0140104
		IN	43.70 x 9.05 x 124.80	M	45°	T	E	VA0140110
		EX	38.10 x 8.67 x 125.00	A	45°	T	E	VE0140105
		EX	38.10 x 8.75 x 125.00	A	45°	T	E	VE0140107
		EX	38.10 x 9.05 x 125.00	A	45°	T	E	VE0140109
Motor 250 - Opala, Caravan - 1969->1979 / Motor 151 - C10, Veraneio - 1976->1979 / Motor 292 - C60 - 1980->	4-6	EX	38.10 x 8.67 x 125.00	A	45°	T	E	VE0140105
		EX	38.10 x 8.75 x 125.00	A	45°	T	E	VE0140107
		EX	38.10 x 9.05 x 125.00	A	45°	T	E	VE0140109
Motor 261 - C10, C60, Veraneio - 1964->1979	4-6	IN	47.60 x 8.70 x 162.20	CS	60°	T	E	VA0140106
Motor 327 - 1962->1968 / Motor 350 - 1968->1986 / Motor 400SB	6-8	EX	38.10 x 8.67 x 125.00	A	45°	T	E	VE0140105
		EX	38.10 x 8.75 x 125.00	A	45°	T	E	VE0140107
		EX	38.10 x 9.05 x 125.00	A	45°	T	E	VE0140109
Motor 1.0 16v - Corsa - Gasolina	4	IN	25.00 x 5.96 x 104.12	CP/M	45°15'	C	C	VA0140026
		EX	19.80 x 5.94 x 103.00	A/M/CP	Stellite 44°45'	C	C	VE0140025
Motor 1.0 8v EFI / MPFI - Gasolina / Álcool / Motor 1.0 8v VHC - Gasolina / Flex / Motor 1.4 EFI - Corsa - Até Fev/1996 - Gasolina	4	IN	32.98 x 7.00 x 105.00	CP/M	44°	A	C	VA0140015
			28.98 x 6.99 x 105.00	A/CP	44°	A	A	VE0140014
Motor 1.0 8v - Onix - Flex - 2012-> / Motor 1.0 8v VHCE - Celta, Corsa - Flex	4	IN	33.00 x 5.96 x 104.70	M/LCP	46°	C	C	VA0141431
		EX	29.00 x 5.95 x 104.70	AB/M/N	46°	C	C	VE0141576
Motor 1.4 / 1.6 / 1.6S - Chevette - Gasolina / Álcool	4	IN	38.98 x 7.97 x 98.45	CP/M	44°	A	C	VA0140084
		IN	38.98 x 8.05 x 98.45	CP/M	44°	A	C	VA0140084 0,076
		IN	38.98 x 8.10 x 98.45	CP/M	44°	A	C	VA0140084 0,127
		IN	38.98 x 8.12 x 98.45	CP/M	44°	A	C	VA0140084 0,152
		IN	38.98 x 8.22 x 98.45	CP/M	44°	A	C	VA0140084 0,254
		IN	38.98 x 8.27 x 98.45	CP/M	44°	A	C	VA0140084 0,304
		IN	38.98 x 8.35 x 98.45	CP/M	44°	A	C	VA0140084 0,381
		IN	38.98 x 8.48 x 98.45	CP/M	44°	A	C	VA0140084 0,508
		IN	38.98 x 8.73 x 98.45	CP/M	44°	A	C	VA0140084 0,762
		EX	31.98 x 7.96 x 98.95	A/CS	44°	A	A	VE0140083
		EX	31.98 x 8.03 x 98.95	A/CS	44°	A	A	VE0140083 0,076
		EX	31.98 x 8.08 x 98.95	A/CS	44°	A	A	VE0140083 0,127
		EX	31.98 x 8.11 x 98.95	A/CS	44°	A	A	VE0140083 0,152
		EX	31.98 x 8.21 x 98.95	A/CS	44°	A	A	VE0140083 0,254
		EX	31.98 x 8.26 x 98.95	A/CS	44°	A	A	VE0140083 0,304
		EX	31.98 x 8.34 x 98.95	A/CS	44°	A	A	VE0140083 0,381
		EX	31.98 x 8.46 x 98.95	A/CS	44°	A	A	VE0140083 0,508
Motor 1.4 8v SOHC - Agile, Corsa, Meriva, Montana, Prisma - Bicomustível / Econoflex / Motor 1.4 8v - Onix - 2012-> - Flex	4	IN	38.00 x 5.97 x 104.96	M/CP	44°30'	C	C	VA0141396
		EX	31.00 x 5.94 x 105.00	AB/M/N	46°	C	C	VE0141573

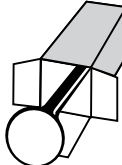
	Nº CIL.	TIPO TYPE						
Motor 1.6 16v - Corsa, Tigra - Gasolina	4	IN	31.00 x 5.96 x 103.15	CP/M	45°	C	A	VA0140076
		EX	27.50 x 5.94 x 102.20	A/CP/M/ST	Stellite 45°	C	A	VE0140075
Motor 1.6 8v C16NZ - Corsa - Gasolina / Motor 1.8 8v - Corsa, Meriva, Montana - Gasolina	4	IN	38.00 x 7.00 x 101.50	CP/M	44°	A	C	VA0140086
		EX	31.00 x 6.90 x 101.50	A/CP/M	46°	A	E	VE0140085
Motor 1.6 16v Ecotec (LFJ) - Sonic - 2012-> - Flex	4	IN	31.20 x 4.98 x 105.71	M/N	45°30'	C	E	VA0141581
		EX	27.50 x 4.96 x 104.84	AB/N	45°30'	C	C	VE0141582
Motor 1.6 / 1.8 - Fase 1 - Monza - Gasolina / Álcool	4	IN	40.98 x 7.98 x 106.45	CP/CS	44°	A	E	VA0140114
		IN	40.98 x 8.05 x 106.45	CP/CS	44°	A	E	VA0140114 0,076
		IN	40.98 x 8.36 x 106.45	CP/CS	44°	A	E	VA0140114 0,381
		IN	40.98 x 8.74 x 106.45	CP/CS	44°	A	E	VA0140114 0,762
		EX	34.98 x 7.96 x 106.10	A/CP	44°	A	E	VE0140113
		EX	34.98 x 8.04 x 106.10	A/CP	44°	A	E	VE0140113 0,076
		EX	34.98 x 8.35 x 106.10	A/CP	44°	A	E	VE0140113 0,381
		EX	34.98 x 8.73 x 106.10	A/CP	44°	A	E	VE0140113 0,762
Motor 1.8 Fase 2 - Monza, Kadett, Ipanema - Gasolina / Álcool	4	IN	41.80 x 7.00 x 104.20	CP/M	44°	A	C	VA0140040
		EX	36.50 x 6.99 x 104.00	AB/M/CP	Stellite 44°	A	A	VE0140039
Motor 1.8 16v Família 1 - Meriva, Stilo - Gasolina	4	IN	31.20 x 5.96 x 101.40	M/CP	44°30'	C	C	VA0140226
		EX	27.50 x 5.94 x 100.76	A/M/ST/CP	45°	C	C	VE0140248
Motor 1.8 8v - Corsa, Meriva, Montana, Spin, Cobalt - Flex	4	IN	37.96 x 5.97 x 101.63	M/CP/SH	44°	C	C	VA0251614
		EX	31.05 x 5.94 x 101.56	A/M/N	44°	C	C	VE0251615
Motor 1.8 16v Ecotec 6 (N18XFF) - Cruze - 2011-> - Flex	4	IN	31.30 x 4.97 x 102.41	M/N	45°30'	C	C	VA0141579
		EX	27.50 x 4.96 x 101.78	AB/N	45°30'	C	C	VE0141580
Motor 1.8 8v - Astra - 1999->2001 - Gasolina / Motor 1.8 8v - Astra - Álcool / Motor 2.0 8v Nacional / 2.2 8v - Astra e Vectra - Gasolina / Álcool / Flex / Motor 2.2 8v / 2.4 8v - S10 - Gasolina / Flex	4	IN	41.80 x 7.00 x 104.20	CP/M	44°	A	C	VA0140040
		EX	36.50 x 6.99 x 104.00	AB/M/CP	Stellite 44°	A	A	VE0140039
Motor 2.0 8v Carburado - Monza, Ipanema, Kadett / Motor 2.0 8v Nacional / 2.2 8v - Astra e Vectra - Gasolina / Álcool	4	IN	43.00 x 7.00 x 104.20	CP/M	46°	A	A	VA0140041
		EX	36.50 x 6.99 x 104.00	AB/M/CP	Stellite 44°	A	A	VE0140039
Motor 2.0 16v - Astra Geração 2 / Motor 2.0 16v / 2.2 16v - Vectra Geração 2 / Motor 2.4 - Blazer, S10 - Gasolina	4	IN	32.00 x 5.90 x 102.10	CP/M	45°20'	C	A	VA0140072
		EX	29.00 x 5.96 x 92.20	A/CP/M/ST	Stellite 44°45'	C	A	VE0140071
Motor 2.4 8v X24XF / N24XF - Blazer, S10 - Flex	4	IN	41.80 x 7.00 x 104.20	M	46°	C	C	VA0141705
		EX	36.50 x 6.98 x 104.00	A/M	46°	C	E	VE0141706
Motor 2.2 HS / HST - S10, Blazer, Silverado - Diesel	4	IN	38.95 x 7.97 x 116.38	A/M/CP	30°	C	A	VA0570250
		EX	36.50 x 7.97 x 116.38	A/M/CP	45°	C	A	VE0570230
Motor 2.4 16v Ecotec - Captiva - 2009-> - Gasolina	4	IN	30.10 x 5.95 x 100.96	AB/CS/CP	45°20'	C	C	VA0141575
		EX	35.00 x 5.96 x 102.40	M/N	45°30'	C	C	VE0141574
Motor 2.8 16v Duramax XLD28 - S10, Trailblazer - Diesel	4	IN	31.75 x 5.96 x 107.60	M	45°30'	C	C	VA0141708
		EX	29.35 x 5.96 x 107.85	AB/M/ST	Stellite 45°30'	C	C	VE0141709
Motor 4.3 V6 Vortec L35 200HP - Blazer, S10 - Gasolina	6	IN	49.20 x 8.67 x 123.95	CP/CS	45°	F	C	VA0140183
		EX	38.10 x 8.67 x 125.00	A/CP	45°	F	C	VE0140184
Motor 4236 - Injeção Indireta - D10	6	IN	44.20 x 9.47 x 122.80	CP/M	45°	A	A	VA0570024
		EX	36.68 x 9.45 x 123.20	A/CP	45°	A	A	VE0570023



	Nº CIL.	TIPO TYPE						
Motor Q20B43 Up-Grade / S4 - D20	4	IN	44.22 x 9.47 x 122.72	CP/M	45°	C	A	VA0570123
Motor Q20B4236 / 4248 / Q20B6354 - D20	4	IN	44.18 x 9.47 x 122.80	A/M/ST/CP	45°	C	C	VE0570122
Motor S4T / S4T Plus 4.0L / P4000 / P4000T - D20	4	IN	44.20 x 9.48 x 122.50	A/M/CP	30°	C	A	VA0570657
Motor 4.07TCA, 4.07TCE, 6.07T, 6.07TCA - Sprint - Silverado, Blazer, S10 - Diesel	4-6	IN	33.00 x 6.96 x 105.10	M/CP	30°	C	A	VA0130277
Motor 3114 4400cc - 924F / Motor 3116 6600cc Turbo - 960F, 950F, 325, 325L - Chevrolet Kodiak	4-6	IN	47.00 x 8.00 x 177.18	A/M	60°45'	A	C	VA0110232
Motor XD3 Turbo - Pick Up C10 - Diesel	4	IN	42.38 x 8.48 x 115.95	M/CP	45°	A	E	VA0440567
Motor XD3 Turbo - Pick Up C10 - Diesel	4	IN	42.38 x 8.48 x 115.95	M/CP	45°	A	E	VA0440567+04
Motor XD3 Turbo - Pick Up C10 - Diesel	4	IN	42.38 x 8.48 x 115.95	M/CP	45°	A	E	VA0440567+08
Motor XD3 Turbo - Pick Up C10 - Diesel	4	EX	35.38 x 8.46 x 116.15	A/CP	45°	A	A	VE0440581
Motor XD3 Turbo - Pick Up C10 - Diesel	4	EX	35.38 x 8.46 x 116.15	A/CP	45°	A	A	VE0440581+04
Motor XD3 Turbo - Pick Up C10 - Diesel	4	EX	35.38 x 8.46 x 116.15	A/CP	45°	A	A	VE0440581+08

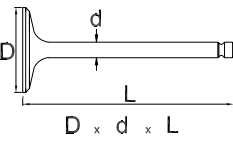
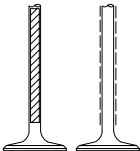
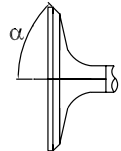

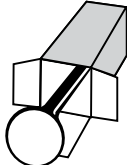
	Nº CIL.	TIPO TYPE						
Motor 100cc - Motocicleta POP, Dream / Biz - 1998->	1	IN	23.00 x 5.00 x 65.90	M	45°30'	A	C	VA0510126
		EX	20.00 x 5.00 x 65.30	A/M/N	45°30'	A	C	VE0510127
Motor 110cc - Motocicleta Lead - Gasolina	1	IN	25.50 x 4.99 x 76.70	M/N	45°15'	A	C	VA0511710*
		EX	21.00 x 4.97 x 74.40	X/M/N	45°15'	A	C	VE0511711*
Motor 110cc - Motocicleta Biz, Pop - Gasolina	1	IN	25.50 x 4.98 x 76.70	M/N	45°15'	A	C	VA0511724*
		EX	21.00 x 4.95 x 74.50	A/M/N	Stellite 45°15'	A	C	VE0511725*
Motor 125cc - Motocicleta Turuna - Até Dez/1982	1	IN	30.00 x 5.50 x 92.00	CP/M	45°15'	A	E	VA0510115
Motor 125cc - Motocicleta Turuna, ML, XL125S, Duty - 1983->	1	IN	30.00 x 5.50 x 92.30	M	45°15'	A	C	VA0510116
Motor 125cc - Motocicleta Turuna / Motocicleta ML, XL125S, Duty - 1983->	1	EX	25.00 x 5.40 x 91.40	A	Stellite 45°30'	A	C	VE0510117
Motor 125cc - Motocicleta CG, ML - Até 1990 / Motor 125cc - Motocicleta CG Today, Cargo - Até 1991	1	IN	29.00 x 5.50 x 93.30	A	45°30'	A	C	VA0510045
		EX	24.00 x 5.40 x 92.60	A	Stellite 45°30'	A	C	VE0510046
Motor 125cc - CH125 - 1993->, Titan, XLR, CG Today, Cargo - 1991->	1	IN	30.00 x 5.43 x 92.88	A	45°15'	A	C	VA0510029
		EX	25.00 x 5.43 x 92.30	A	Stellite 45°15'	A	C	VE0510030
Motor 125cc - Motocicleta Biz - Gasolina	1	IN	24.00 x 5.00 x 72.00	M/CP	45°15'	A	C	VA0510227
		EX	21.00 x 5.00 x 72.00	A/M/CP	45°15'	A	C	VE0510228
Motor 125cc - Motocicleta Titan - 2002->2004 / Fan - 2009-> - Gasolina	1	IN	29.00 x 5.00 x 93.40	A/M	45°	A	C	VA0510195
		EX	24.94 x 5.00 x 92.30	A/M	45°	A	C	VE0510196
Motor 125cc - Motocicleta CG FAN (ES/KS/Cargo) - Carburada / Injeção Eletrônica - 2009-> - Gasolina / Mix	1	IN	26.99 x 4.98 x 83.61	M/N	45°30'	A	C	VA0511477
		EX	23.03 x 4.96 x 82.48	A/N	45°30'	A	C	VE0511478
Motor 150cc - Motocicleta CBX150 Aero, NX150 - 1988->	1	IN	31.50 x 5.50 x 89.00	CP/M	45°	A	E	VA0510070
		EX	27.00 x 5.50 x 88.80	A/CP/M/ST	Stellite 45°30'	A	C	VE0510069
Motor 150cc - Motocicleta Titan - Gasolina - 2004->	1	IN	30.00 x 5.00 x 83.40	CP/M	45°	A	C	VA0510197
		EX	26.00 x 5.00 x 82.60	A/CP/M	45°	A	C	VE0510198
Motor 150cc - Motocicleta CG KVS - 2010->	1	IN	30.00 x 4.99 x 83.40	M/N	45°	A	C	VA0511425
		EX	26.00 x 4.97 x 82.60	A/N	Stellite 45°	A	C	VE0511426
Motor 160cc - Motocicleta Titan, Fan, NXR Bros, Start - Flex	1	IN	30.00 x 4.98 x 87.15	M/N	45°	A	C	VA0511696
		EX	26.00 x 4.96 x 86.50	A/ST/N	Stellite 45°	A	C	VE0511697
Motor 190cc - Motocicleta XRE - Flex	1	IN	31.45 x 4.98 x 85.25	M/N	45°	A	C	VA0511726*
		EX	26.00 x 4.96 x 84.15	A/M/N	Stellite 45°	A	C	VE0511727*
Motor 200cc - Motocicleta CBX Strada - 1993->2002 / Motocicleta XR200R - 1995->2001 / Motor 230cc - Motocicleta CRF	4	IN	31.50 x 5.46 x 89.63	M/N	45°	A	C	VA0511634
		EX	27.00 x 5.44 x 89.20	AB/M/N	45°	A	C	VE0511635
Motor 250cc - Motocicleta CBX Twister, XR Tornado / Motor 300cc - Motocicleta Twister, Tornado, CB300R, NXR300, XRE300	1	IN	28.00 x 5.00 x 83.50	M/N	45°15'	A	C	VA0510128
		EX	23.50 x 5.00 x 83.20	A/M/N	45°45'	A	C	VE0510129
Motor 250cc - Motocicleta CB Twister - 2015-> - Flex	1	IN	25.00 x 5.00 x 82.85	M/N	45°30'	A	C	VA0511744*
		EX	21.50 x 5.00 x 83.30	X/M/N	45°30'	A	C	VE0511745*
Motor 250cc - Motocicleta XLR	1	IN	28.00 x 5.50 x 87.40	M/N	45°15'	A	C	VA0510130
		EX	25.50 x 5.50 x 87.30	A/M/N	45°15'	A	C	VE0510131

(*) Item sob consulta

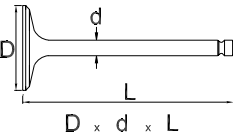
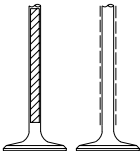
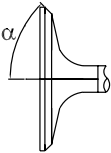

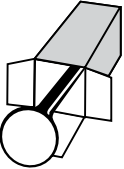
	Nº CIL.	TIPO TYPE						
Motor 250cc - Motocicleta XLR	1	IN	29.00 x 5.50 x 105.10	A/CP/M	45°15'	A	C	VA0510132
		EX	26.00 x 5.50 x 104.00	A/CP/M	45°	A	C	VE0510133
Motor 350cc - Motocicleta XLX	1	IN	32.00 x 5.50 x 103.40	CP/M	45°15'	A	C	VA0510134
		EX	29.00 x 5.50 x 101.80	A/CP/M	45°	A	C	VE0510135
Motor 400cc - Motocicleta CB	2	IN	26.00 x 5.50 x 95.00	M	45°15'	A	C	VA0510191
		EX	32.00 x 6.60 x 100.60	A	45°	A	C	VE0510192
Motor 400cc - Motocicleta NX 400I Falcon	1	IN	33.00 x 5.48 x 102.60	AB/M/CP	45°	A	C	VA0510269
		EX	29.00 x 5.50 x 101.00	M	45°30'	A	C	VE0510270
Motor 600cc - Motocicleta CB Hornet - Até 2007	4	IN	25.50 x 3.98 x 79.33	M/N	45°	A	C	VA0511628
		EX	21.97 x 3.97 x 79.32	X/M/N	45°	A	C	VE0511629
Motor 600cc - Motocicleta CB Hornet - 2008->	4	IN	27.48 x 3.98 x 88.60	M/N	45°	A	A	VA0511630
		EX	22.52 x 3.97 x 88.76	X/M/N	45°	A	A	VE0511631
Motor 1.4 8v - Fit - Gasolina	4	IN	31.96 x 5.49 x 118.35	M/CP	45°	A	C	VA0510263
		EX	28.08 x 5.45 x 118.12	AB/M/CP	45°15'	A	C	VE0510264
Motor 1.4 16v L13Z3 / 1.5 16v L15A8 - New Fit - 2008-> - Flex / Motor 1.5 16v L15A - Fit, City - 2014-> Flex	4	IN	28.03 x 5.48 x 118.80	M/N	45°30'	A	C	VA5511554
			22.96 x 5.45 x 117.43	A/M/ST/N	45°30'	A	C	VE5511555
Motor 1.5 16v - Fit - Gasolina	4	IN	27.42 x 5.48 x 118.39	M/CP/SH	45°	A	C	VA0510265
		EX	23.05 x 5.45 x 117.52	AB/M/CP	45°	A	C	VE0510266
Motor 1.6 16v D16Z / 1.7 16v - Civic LX - Gasolina	4	IN	30.00 x 5.47 x 118.50	M/CP	45°	A	C	VA0510209
		EX	26.00 x 5.46 x 115.95	AB/M/CP	45°15'	A	C	VE0510210
Motor 1.8 16v R18A1 - Civic, HRV - Flex	4	IN	33.00 X 5.48 X 117.85	M/N	45°	A	C	VA5511748*
Motor 1.8 16v R18A1 - Civic, HRV - Flex / Motor 2.0 16v R20A1 - CRV - Gasolina	4	EX	26.00 x 5.46 x 115.95	X/M/ST/N	45°15'	A	C	VE5511749*
Motor 1.8 16v R18A1 - New Civic - Gasolina	4	IN	31.94 x 5.49 x 116.62	M/CP/SH	45°30'	A	C	VA0510257
		EX	26.00 x 5.50 x 115.95	M/N	45°15'	A	C	VE0510258
Motor 2.0 16v R20A1 - CRV - Gasolina / Motor 2.0 16v R20A2 - New Civic, CRV - Flex	4	IN	31.95 x 4.98 x 116.70	A/M/N	45°30'	A	C	VA5511568
		EX	26.00 x 4.96 x 115.95	A/M/ST/N	45°15'	A	C	VE5511569
Motor 2.0 16v R20A2 - New Civic, CRV - Flex	4	IN	31.94 x 5.49 x 116.62	M/CP/SH	45°30'	A	C	VA0510257
		EX	26.00 x 5.46 x 115.95	AB/M/CP	45°15'	A	C	VE0510210

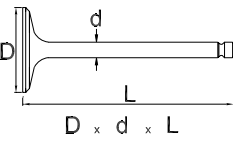
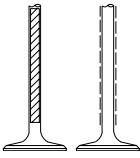
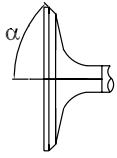
(*) Item sob consulta

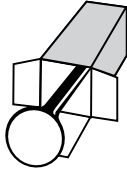

	Nº CIL.	TIPO TYPE						
Motor Mazda FE - Empilhadeira H55 XM	4	IN	33.70 x 5.99 x 103.20	A/N	45°30'	A	C	VA2111419
		EX	28.95 x 5.98 x 103.95	A/N	45°	A	C	VE2111420

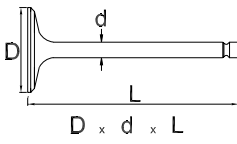
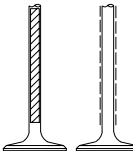
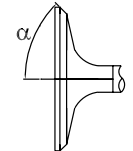

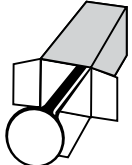
	Nº CIL.	TIPO TYPE						
Motor 1.0 12v Kappa 3cil - HB20 - 2012-> - Flex	4	IN	26.80 x 5.47 x 92.85	M/N	45°30'	A	C	VA2081664
		EX	24.13 x 5.46 x 93.45	A/N/ST	45°30'	A	C	VE2081665
Motor 1.6 16v Gamma - Veloster, HB20, Cerato, Soul - Flex	4	IN	31.50 x 5.47 x 93.20	M/N	45°30'	A	E	VA2081552
		EX	26.00 x 5.46 x 92.60	A/N	45°30'	A	E	VE2081553
Motor 2.0 16v G4GC Beta 2 - Tucson, i30, Sportage - 2005-> - Gasolina	4	IN	31.94 x 5.98 x 114.34	M/N	45°	A	C	VA2081417
		EX	27.45 x 5.95 x 116.78	A/N	45°	A	E	VE2081418
Motor 2.0 16v Theta 2 F4NA - Tucson, iX35, Elantra - Flex	4	IN	32.99 x 5.48 x 102.44	M/N	45°	A	E	VA2081728*
		EX	27.00 x 5.47 x 104.22	A/M/N	45°	A	E	VE2081729*
Motor 2.5 4D55 / 4D56 - H100 - Diesel	4	IN	42.00 x 7.98 x 135.85	M/CP	44°30'	A	C	VA2080849
		EX	36.05 x 7.95 x 136.00	A/M/CP	45°	A	A	VE2080848
Motor 2.5 D4BB - H100 - Diesel	4	IN	42.00 x 7.97 x 132.00	M/CP/SH	45°	F	C	VA2081301
		EX	35.95 x 7.97 x 131.90	A/M/ST/CP	45°	F	C	VE2081302
Motor 2.5 Euro 5 - HR - Diesel	4	IN	31.80 x 6.97 x 110.53	M/N	45°	C	A	VA2111594
		EX	28.00 x 6.94 x 110.49	A/M/N	44°30'	C	A	VE2111595

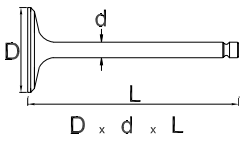
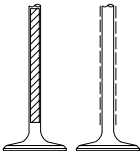
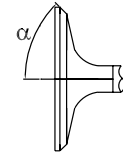

(*) Item sob consulta

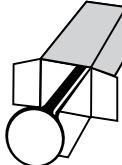

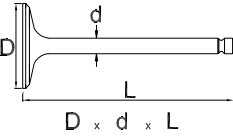
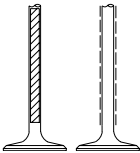
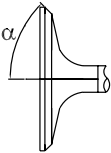
	N° CIL.	TIPO TYPE						
Motor D414 / D436 / D466 (N.T.) / DT414 / DT436 / DT466 - Turbo - 210HP	6	IN	50.02 x 9.45 x 146.95	M/N	30°	F	A	VA0380226*
		EX	40.62 x 9.43 x 147.07	A/ST/CP	45°	F	A	VE0380227*
Motor DTA360 5.9L Turbo - 150HP / 170HP	6	IN	43.40 x 9.45 x 144.50	A/CP	30°	F	A	VA0380228*
		EX	36.93 x 9.42 x 144.48	A/ST/CP	45°	A	A	VE0380229*
Motor NGD DT408 / DT466 - Turbo - 185HP (5/16")	6	IN	50.05 x 7.94 x 147.00	M/CP	30°	F	A	VA0380231*
		EX	40.75 x 7.91 x 147.15	A/ST/CP	45°	A	A	VE0380230*
Motor NGD DT466E - 250HP (3/8")	6	IN	45.30 x 9.46 x 152.27	M/CP	30°	F	A	VA0381304*
		EX	45.35 x 9.43 x 153.80	A/ST/CP	45°	F	A	VE0381312*
Motor NGD 9.3E 370cv - Volkswagen Constellation 19370, 25370 Tractor, 31370	6	IN	39.80 x 7.93 x 147.97	M	60°	A	C	VA0381699
		EX	36.50 x 7.90 x 147.58	A/M	45°	A	C	VE0381700

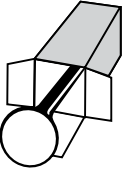

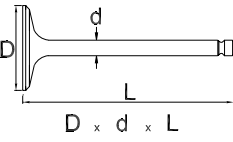
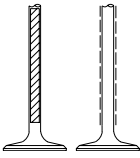
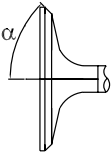
(*) Item sob consulta

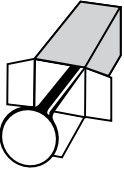
	N° CIL.	TIPO TYPE						
Motor 8140.07 Turbo - Daily 40.8 / Motor 8140.23 2.5 TDS-TDSE - Marengo, Ducato - 1978->1983 / Motor 2.8 Turbo - New Daily 40.10, 45.10, 49.10	4	IN	40.90 x 7.99 x 120.90	M/CP	30°	A	A	VA0010211
		EX	35.90 x 7.99 x 121.95	A/M/CP	44°30'	A	A	VE0010212
Motor 8140.47 2.5 Aspirado - Ducato / Motor 2.8 Aspirado - New Daily 35.10, A45.10, 49.10, Daily, Ducato	4	IN	43.35 x 7.99 x 121.80	AB/M/CP	60°	A	C	VA0250513
		EX	35.90 x 7.99 x 121.95	A/M/CP	44°30'	A	A	VE0010212
Motor FPT F1A 2.3 16v Euro 4 - 2011->	4	IN	30.00 x 5.98 x 120.39	M/LCP	45°	C	C	VA0011475
		EX	30.00 x 5.98 x 120.39	AB/M/CP	45°	C	C	VE0011616
Motor FPT F1C 3.0 16v Euro 3 e 5 - Daily - 2010->	4	IN	32.38 x 5.99 x 119.94	M/CP	60°	C	C	VA0011467
			32.33 x 5.98 x 119.96	AB/M/CP	60°	C	C	VE0011468
Motor FCA NEF6 5.9L 24v SOHV - Tector F4AE	4-6	IN	33.00 x 7.00 x 124.65	M/CP	30°	A	C	VA0210442
		EX	33.00 x 7.00 x 124.28	A/M/CP	45°	A	C	VE0210443
Motor Cursor 13 12.8L 24v Euro 3 - Stralis, Traker - 2005->	6	IN	46.96 x 9.98 x 199.23	M/CP	60°30'	A	C	VA0011469
Motor Cursor 13 12.8L 24v Euro 3 - Stralis, Traker - 2005-> / Motor Cursor 13 F3BE3681K 12.9L 24v Euro 5 - 2012-> - Diesel	6	EX	45.91 x 9.98 x 198.10	A/M/CP	45°30'	A	C	VE0011470

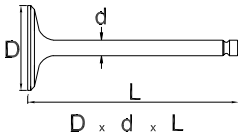
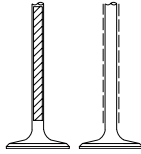
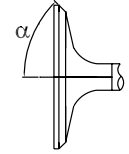

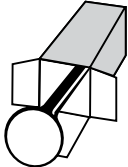
	Nº CIL.	TIPO TYPE						
Motor 1.4 16v - J3 - Gasolina	4	IN	30.57 x 4.97 x 89.89	A/N	45°30'	A	C	VA3551556
		EX	25.56 x 4.96 x 90.93	AB/N	45°15'	A	C	VE3551557

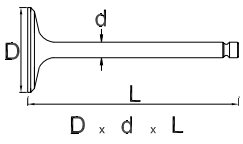
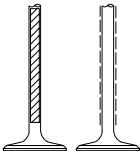
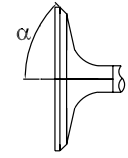
	N° CIL.	TIPO TYPE						
Motor 2600 e 3000 - Jeep, Rural, Pick up - 1965->	6	EX	35.88 x 8.63 x 117.10	A	45°	E	E	VE0230118

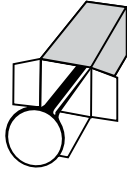

	Nº CIL.	TIPO TYPE						
Motor 4039 DJ01/02-TJ01 / 6059 DJ01-TJ01/02/03 / 6068 DJ01, MUN 4D/4T/6O/6T - Trator	4-6	IN	46.58 x 7.87 x 134.07	M/CP	29°15'	A	A	VA0430546
		IN	46.58 x 8.25 x 134.07	M/CP	29°15'	A	A	VA0430546 0,381
		EX	42.48 x 7.87 x 133.46	A/CP	29°15'	A	A	VE0430542
		EX	42.48 x 8.24 x 133.46	A/CP	29°15'	A	A	VE0430542 0,381

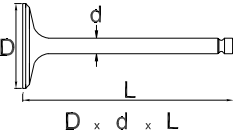
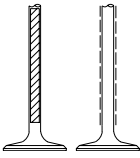
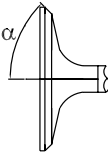

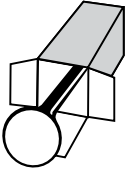
	Nº CIL.	TIPO TYPE						
Motor 1.0 12v Kappa 3cil - Picanto - 2012-> - Flex	4	IN	26.80 x 5.47 x 92.85	M/N	45°30'	A	C	VA2081664
		EX	24.13 x 5.46 x 93.45	A/N/ST	45°30'	A	C	VE2081665
Motor 1.6 16v Gamma - Veloster, HB20, Cerato, Soul - Flex	4	IN	31.50 x 5.47 x 93.20	M/N	45°30'	A	E	VA2081552
		EX	26.00 x 5.46 x 92.60	A/N	45°30'	A	E	VE2081553
Motor 2.0 16v G4GC Beta 2 - Tucson, i30, Sportage - 2005-> - Gasolina	4	IN	31.94 x 5.98 x 114.34	M/N	45°	A	C	VA2081417
		EX	27.45 x 5.95 x 116.78	A/N	45°	A	E	VE2081418
Motor 2.0 16v Theta 2 G4KD - Sportage - Flex	4	IN	32.99 x 5.48 x 102.44	M/N	45°	A	E	VA2081728*
		EX	27.00 x 5.47 x 104.22	A/M/N	45°	A	E	VE2081729*
Motor 2.0 / 2.2 - RF / R2 - Besta Magma, Hurricane, Sportage, Bongo - Diesel	4	IN	41.00 x 7.98 x 107.00	M/CP	45°	A	A	VA2110229
		EX	36.00 x 7.97 x 106.95	A/CP	45°15'	A	A	VE2110249
Motor 2.7 FRA - Besta, Besta K2.7, Bongo - Diesel	4	IN	41.10 x 8.97 x 114.65	A/M/CP	44°52'	A	C	VA2110185
		EX	35.00 x 8.96 x 114.60	A/M/CP	29°30'	A	C	VE2110186
Motor 3.0 - Besta GS - Diesel	4	IN	44.05 x 8.48 x 112.70	M/CP	45°	A	A	VA2110187
		EX	37.35 x 8.45 x 112.93	A/M/CP	45°	A	A	VE2110188
Motor Mazda FE - Kia Sportage - 1990->2002	4	IN	33.70 x 5.99 x 103.20	A/N	45°30'	A	C	VA2111419
		EX	28.95 x 5.98 x 103.95	A/N	45°	A	C	VE2111420

(*) Item sob consulta

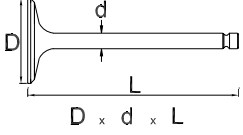
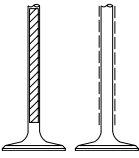
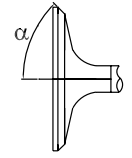

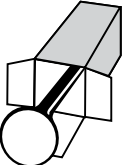
	Nº CIL.	TIPO TYPE						
Motor D08 34 / D08 36	4-6	IN	38.00 x 6.96 x 141.50 34.00 x 6.95 x 141.17	M/CP M/CP	60° 45°	C C	C C	VA0461693 VE0461694
Motor D2676 440cv 12.4 24v - 28440, 29440, 33440 - 2012->	6	IN EX	40.00 x 9.00 x 160.40 38.00 x 9.00 x 160.40	MV/CP X/M/CP	60°10' 45°10'	C C	C C	VA0461734* VE0461735*

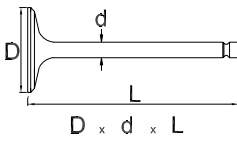
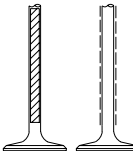
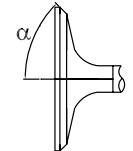
(*) Item sob consulta

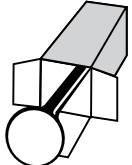

	Nº CIL.	TIPO TYPE						
Motor OM014A - Sprinter 310, 312	4	IN	38.95 x 7.97 x 116.38	A/M/CP	30°	C	A	VA0570250
		EX	36.50 x 7.97 x 116.38	A/M/CP	45°	C	A	VE0570230
Motor OM314 / OM352 / OM352A - Cabeçote Versão Antiga (Bloco Normal)	6	IN	43.98 x 8.94 x 140.45	CP/M/ST	Stellite 45°	E	A	VA0480004
		EX	35.98 x 9.93 x 140.45	CP/M/ST	Stellite 45°	E	A	VE0480003
Motor OM314A / OM352O / OM352A	6	EX	35.98 x 9.93 x 140.45	AB/M/CP	45°	E	A	VE0480097
Motor OM352A / OM364A / OM366A / OM364LA / OM366LA	6	IN	41.98 x 8.94 x 140.45	AB/M/CP	60°	E	A	VA0480006
		IN	41.98 x 8.94 x 140.45	AB/M/CP	60°	E	A	VA0480006+04
		IN	41.98 x 8.94 x 140.45	AB/M/CP	60°	E	A	VA0480006+08
		EX	35.98 x 9.93 x 140.45	AB/M/CP	45°	E	A	VE0480005
		EX	35.98 x 9.93 x 140.45	AB/M/CP	45°	E	A	VE0480005+04
		EX	35.98 x 9.93 x 140.45	AB/M/CP	45°	E	A	VE0480005+08
Motor OM355 - L1521, OH1523	5-6	IN	41.98 x 8.95 x 129.80	CP/M	45°	E	A	VA0480048
		IN	41.98 x 8.95 x 129.80	CP/M	45°	E	A	VA0480048+04
		IN	41.98 x 8.95 x 129.80	CP/M	45°	E	A	VA0480048+08
		EX	36.98 x 8.94 x 165.35	A/CP	Stellite 45°	E	A	VE0480047
		EX	36.98 x 8.94 x 165.35	A/CP	Stellite 45°	E	A	VE0480047+04
		EX	36.98 x 8.94 x 165.35	A/CP	Stellite 45°	E	A	VE0480047+08
Motor OM355/5A / OM355/5LA / OM355/6LA	5-6	IN	42.03 x 8.94 x 129.95	CP/M/ST	Stellite 60°	E	A	VA0480080
		IN	42.03 x 8.94 x 129.95	CP/M/ST	Stellite 60°	E	A	VA0480080+04
		IN	42.03 x 8.94 x 129.95	CP/M/ST	Stellite 60°	E	A	VA0480080+08
		EX	36.98 x 8.94 x 165.10	AB/M/CP	60°	E	A	VE0480079
		EX	36.98 x 8.94 x 165.10	AB/M/CP	60°	E	A	VE0480079+04
		EX	36.98 x 8.94 x 165.10	AB/M/CP	60°	E	A	VE0480079+08
Motor OM346 / OM355/5A / OM355/6A / OM951	6	IN	42.00 x 8.94 x 130.60	M/ST/CP	Stellite 29°55'	E	C	VA0480091
		EX	37.00 x 8.93 x 165.83	AB/M/CP	Stellite 29°55'	E	A	VE0480090
Motor OM364 / OM366	6	IN	42.78 x 8.94 x 140.45	AB/M/CP	60°	E	A	VA0480096
		IN	42.78 x 8.94 x 140.45	AB/M/CP	60°	E	A	VA0480096+04
		IN	42.78 x 8.94 x 140.45	AB/M/CP	60°	E	A	VA0480096+08
		EX	35.98 x 9.93 x 140.45	AB/M/CP	45°	E	A	VE0480097
		EX	35.98 x 9.93 x 140.45	AB/M/CP	45°	E	A	VE0480097+04
		EX	35.98 x 9.93 x 140.45	AB/M/CP	45°	E	A	VE0480097+08
Motor OM364A / OM364LA / OM366A / OM366LA	6	IN	41.98 x 8.94 x 140.50	AB/M/CP	19°55'	E	A	VA0480007
Motor OM421A / OM421LA / OM447LA / OM449A / OM449LA - 1633, 1938	5-6	IN	58.85 x 11.94 x 142.50	AB/M/CP	30°	E	A	VA0480056
		EX	51.00 x 11.93 x 142.50	AB/M/CP	Stellit 45°	E	C	VE0480055
Motor OM457LA Até Euro 3 - Chassi 9BM696080 / OM501LA 24v V6 / OM502LA 32v V8	6-8	IN	45.60 x 8.94 x 144.85	AB/M/CP	30°	A	A	VA0480193
		EX	41.10 x 8.93 x 144.90	AB/M/CP	45°	A	A	VE0480194
Motor OM457LA Até Euro 3 - Chassi 9BM958... - Axor 2044, 2544, 2644, O500RS/RSD, O400RSD / Motor 457LA Euro 5 / Motor OM460	6	IN	45.50 x 8.94 x 144.85	M/CP	30°	A	C	VA0481436
		EX	42.10 x 8.93 x 144.85	AB/M/CP	35°	A	C	VE0481437
Motor OM601 / OM611LA 2.2 16v / OM612LA 2.7 20v - C200, C220, C270, Sprinter 311, 313, 413	4-5	IN	30.20 x 6.97 x 104.00	M/N	45°	A	C	VA0480233
		EX	28.40 x 6.96 x 104.00	A/N	45°	A	C	VE0480251
Motor OM651LA 2.2L - Sprinter 311, 415, 515 CDI - 2012->	4	IN	28.50 x 5.97 x 108.90	M/CP	45°	C	A	VA0481563
		EX	24.60 x 5.96 x 109.20	AB/M/CP	45°	C	A	VE0481564

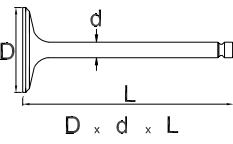
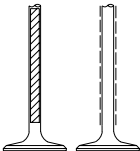
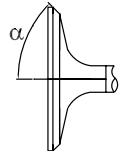
	Nº CIL.	TIPO TYPE						
Motor OM904LA / OM906LA / OM924LA / OM926LA - Até Euro 5	4-6	IN	34.00 x 7.95 x 128.75	AB/M/CP	20°	A	A	VA0480244
		EX	38.00 x 7.94 x 152.55	AB/M/CP	45°15'	A	A	VE0480245
Motor OM904LA / OM906LA / OM924LA / OM926LA - Até Euro 3	4-6	IN	34.00 x 7.95 x 128.75	AB/M/CP	20°	A	A	VA0480244
		EX	38.00 x 7.93 x 152.55	AB/M/CP	36°	A	A	VE0481487*
Motor OM924LA / OM926LA - Euro 5	4-6	EX	38.00 x 7.93 x 152.55	AB/M/CP	36°	A	A	VE0481487*
Motor OM447 - Top Brake	6	IN - EX	17.00 x 7.99 x 86.87	AB	45°	A	B	VC0481565
Motor OM457LA / OM460LA - Top Brake	6	IN - EX	17.00 x 8.00 x 86.80	AB/CP	45°	A	C	VC0481345
Motor OM904LA / OM906LA - Top Brake	4-6	IN - EX	15.20 x 5.97 x 81.60	A/CP	20°	A	A	VC0481344

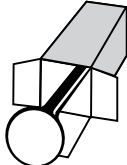

(*) Item sob consulta

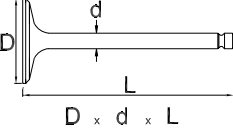
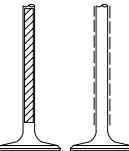
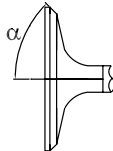
	Nº CIL.	TIPO TYPE						
Motor 2.0 4G63 / 2.4 16v 4G64 - Galant - Gasolina	4	IN	32.90 x 5.96 x 112.52	M/CP	45°	A	C	VA1950261
		EX	29.00 x 5.96 x 114.11	A/M/N	45°15'	A	C	VE1950262
Motor 2.0 4G94 - Pajero TR4 - Gasolina / Flex	4	IN	30.00 x 5.97 x 110.15	M/N	45°15'	A	C	VA1951571
Motor 2.0 4G94 - Pajero TR4 - Gasolina	4	EX	27.00 x 5.96 x 113.70	A/M/N	45°15'	A	C	VE1951572
Motor 2.0 4G94 - Pajero TR4 - Flex	4	EX	27.00 x 6.00 x 114.00	A/M/LCP	45°	A	C	VE1950828*
Motor 2.5 8v 4D56 HPE - L200 Sport, Pajero - Diesel	4	IN	40.00 x 8.00 x 130.00	MN	45°15'	A	E	VA1950254
		EX	34.00 x 8.00 x 130.00	A/M/CP	45°15'	A	C	VE1950238
Motor 2.5 4D56 Aspirado / Turbo - L200 GL/GLS, L300, Pajero - Diesel	4	IN	39.95 x 7.97 x 130.10	A/M/N	45°	A	A	VA1950223
		EX	34.00 x 7.95 x 130.00	A/M/N	45°15'	A	A	VE1950224
Motor 2.8 4M40 Turbo - Pajero - Diesel	4	IN	41.00 x 7.97 x 108.70	M/CP	45°15'	A	A	VA1950247
		EX	35.00 x 7.94 x 108.35	A/CP	44°15'	A	A	VE1950246
Motor 3.0 12v 6G72 - Pajero Galant - 1988->2005 - Gasolina	6	IN	43.00 x 8.00 x 103.00	A/M/CP	45°15'	A	C	VA1950234
		EX	35.00 x 8.00 x 103.00	A/CS	45°15'	A	C	VE1950235
Motor 3.0 6G72 / 3.5 24v 6G74 - Pajero 1999->2004 - Gasolina	4	IN	32.90 x 5.96 x 112.52	M/CP	45°	A	C	VA1950261
		EX	29.00 x 5.96 x 114.11	A/M/N	45°15'	A	C	VE1950262
Motor 3.2 4M41 - Pajero Full - Diesel	4	IN	33.00 x 7.00 x 106.00	A/N	45°15'	A	C	VA1950236
		EX	31.00 x 7.00 x 105.00	A/N	45°15'	A	C	VE1950237
Motor 4G64	4	IN	46.00 x 7.96 x 106.83	M/CP	44°45'	A	C	VA1950825*
		EX	37.90 x 7.94 x 105.03	A/CP	45°	A	E	VE1950826*

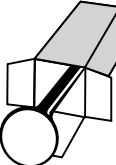

(*) Item sob consulta

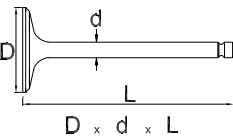
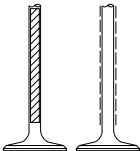
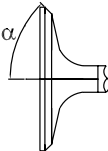

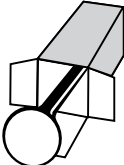
	Nº CIL.	TIPO TYPE						
Motor D225 / D226 / D229 / D229EC / D327 (Exceto VW12140 e 14140) / TD229 (Fiat FE105B), Ford Serie F (Exportação)	3-4-6	IN	40.98 x 8.96 x 116.95	CP/M	44°30'	C	A	VA0130011
		EX	37.98 x 8.96 x 116.95	CP/M	44°45'	C	A	VE0130010
Motor D229EC / TD225 / TD229 / TDB229EC (Exceto Fiat FE105B), Ford Serie F	4-6	IN	42.00 x 8.97 x 117.15	CP/M	30°	C	A	VA0130099
		EX	38.00 x 9.00 x 117.00	A/M/ST/CP	45°	C	A	VE0130098
Motor 4.07TCA, 4.07TCE, 6.07T, 6.07TCA - Sprint	4-6	IN	33.00 x 6.96 x 105.10	M/CP	30°	C	A	VA0130277
		EX	40.00 x 6.97 x 105.10	A/M/ST/CP	45°	C	A	VE0130278
Motor 4.08TCE 3.0 16v - 5140 Delivery	4	IN	33.00 x 6.96 x 105.10	M/CP	30°	C	A	VA0130277
		EX	40.00 x 6.97 x 105.10	A/M/ST/CP	45°	C	A	VE0130278
Motor 4.10 / 4.10T / 4.10TCA / 6.10 / 6.10T / 6.10TCA - Euro 1 / 2 / 3	4-6	IN	45.00 x 8.96 x 126.00	CP/M	60°	C	C	VA0130101
		EX	41.00 x 8.96 x 126.00	A/M/ST/CP	45°	C	A	VE0130100
Motor 4.12TCE / 6.12TCE Euro 3 - 150cv, 180cv, 190cv, 210cv, 230cv, 260cv	4-6	IN	45.00 x 8.96 x 126.00	AB/M/CP	30°	C	A	VA0130933
		EX	41.00 x 8.96 x 126.00	AB/M/CP/SH	45°	C	C	VE0130239
Motor 4.12TCE - MaxxForce Acteon Euro 5 - Volvo VM 220cv, 270cv, 330cv	4	IN	36.50 x 7.00 x 122.00	MV/CP	60°	C	C	VA0131750*
		EX	32.50 x 7.00 x 121.50	AB/M/ST/LCP	45°	C	C	VE0131751*

(*) Item sob consulta

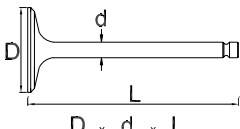
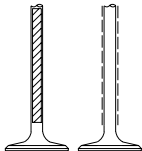
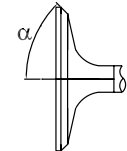

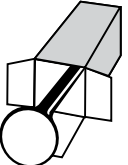
	Nº CIL.	TIPO TYPE						
H20	4	IN	35.10 x 6.97 x 109.75	M/CP	44°30'	E	C	VA0030331*
		EX	30.10 x 6.95 x 109.20	A/CP	44°30'	E	C	VE0031124*
Motor 1.0 16v HR10DE - March - Flex	4	IN	25.92 x 5.47 x 110.75	M/N	45°	C	A	VA0181606 (VA0180427)
		EX	22.16 x 5.46 x 112.65	A/M/N	45°	C	A	VE0181607 (VE0180438)
Motor 1.6 HR16DE - March, Versa - Flex	4	IN	31.70 x 4.97 x 101.64	M/N	45°	A	C	VA0031608
		EX	25.36 x 4.96 x 102.43	M/N	45°	A	C	VE0031609
Motor 1.8 MR18DE - Tiida - Flex / Motor 2.0 16v MR20 - Sentra - Flex	4	IN	33.96 x 5.46 x 106.30	M/ST/N	45°	A	C	VA0031570
		EX	27.80 x 5.45 x 105.30	A/N	45°	A	C	VE0031605
Motor 2.5 16v YD25DTI - Frontier - Diesel	4	IN	28.60 x 5.97 x 105.97	A/N	45.5°	A	C	"VA0031617 (VA0031506)"
		EX	26.00 x 5.95 x 105.54	X/M/N	45.5°	A	C	"VE0031618 (VE0031507)"

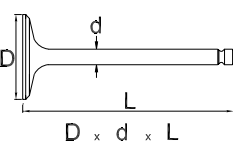
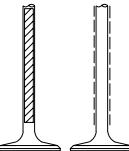
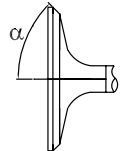

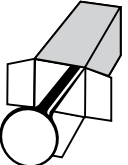
(*) Item sob consulta

	Nº CIL.	TIPO TYPE						
3054 - Séries 4ZK / 6FK / CAT4016C	6	IN	45.00 x 9.46 x 122.87	A/M/CP	60°	A	C	VA0571369
		EX	37.39 x 9.44 x 123.31	A/M/CP	45°	A	C	VE0570649
Motor 3152 / 4203 - Injeção Indireta	3-4-6	IN	38.90 x 7.90 x 114.30	M	45°	A	C	VA0570035
		EX	33.40 x 7.90 x 114.30	M	45°	A	C	VE0570036
Motor D3152 / D4203 - Injeção Direta	4	IN	38.90 x 7.90 x 114.15	M	45°	A	A	VA0570032
		EX	33.30 x 7.90 x 114.30	M	45°	A	A	VE0570031
Motor 6354 Fase 2 / Motor T6354 Fase 2, 3 e 4	6	IN	44.20 x 9.47 x 122.80	CP/M	45°	A	A	VA0570024
		EX	36.68 x 9.45 x 123.20	A/CP	45°	A	A	VE0570023
Motor 6357 - Injeção Indireta	4-6	IN	46.89 x 9.47 x 132.40	CS	45°	A	A	VA0570033
		EX	40.50 x 9.45 x 132.36	M	45°15'	A	C	VE0570034
Motor 6358 - Injeção Direta - V8-510-540	6-8	IN	45.22 x 9.47 x 139.45	A/CP	45°	A	A	VA0570111
		EX	38.88 x 9.46 x 139.75	A/ST/CP	45°	A	A	VE0570112
Motor Q20B4236 / 4248 / Q20B6354	4	IN	44.18 x 9.47 x 122.80	CP/M	45°	C	A	VA0570038
		EX	36.57 x 9.46 x 123.20	A/CP/M	45°	C	A	VE0570037
Motor Q20B43 Up-Grade / S4 - D20	4	IN	44.22 x 9.47 x 122.72	CP/M	45°	C	A	VA0570123
		EX	38.20 x 9.47 x 123.10	A/M/ST/CP	45°	C	C	VE0570122
Motor S4T / S4T Plus 4.0L / P4000 / P4000T - D20	4	IN	44.20 x 9.48 x 122.50	A/M/CP	30°	C	A	VA0570657
		EX	38.20 x 9.47 x 123.10	A/M/ST/CP	45°	C	C	VE0570122
Motor 2.2 HS / HST - S10, Blazer, Silverado, F1000, Ranger, Sprinter, Land Rover	4	IN	38.95 x 7.97 x 116.38	A/M/CP	30°	C	A	VA0570250
		EX	36.50 x 7.97 x 116.38	A/M/CP	45°	C	A	VE0570230
Motor 2.5 HS-TDS / 2.8 HS-TDS - Sprinter, Jeep, Defender, Land Rover, S10, F1000, Ranger, Troller	4	IN	38.95 x 7.97 x 116.38	A/M/CP	30°	C	A	VA0570250
		EX	36.50 x 7.97 x 116.38	A/M/CP	45°	C	A	VE0570230
Motor 3.0 16v HS TDI - Ranger, Troller	4	IN	32.00 x 5.94 x 114.19	M/CP	45°	C	C	VA0570231
		EX	29.00 x 5.93 x 114.20	AB/M/CP	45°	C	C	VE0570232
Motor P3, P3-144, P4, P6, 6305	3-4-6	IN	38.90 x 7.90 x 114.30	M	45°	A	C	VA0570035
		IN	38.90 x 7.90 x 114.30	M	45°	A	C	VA0570035+04
		IN	38.90 x 7.90 x 114.30	M	45°	A	C	VA0570035+08

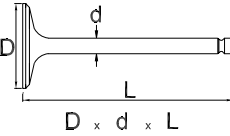
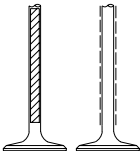
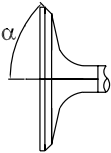

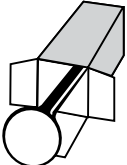
	N° CIL.	TIPO TYPE						
Motor 1.0 8v - TU9K, TU9M, TU9A - 106, 205, Audace, Escape, AX10E, Saxo - Gasolina	4	IN	34.70 x 6.97 x 112.77	M	30°	A	C	VA0440572
		EX	27.80 x 6.97 x 112.60	A/M/CP	45°	A	C	VE0440593
Motor 1.3 / 1.4 TU3FJ2K - Saxo, Xsara / Motor 1.4 TU5J2 - 106, 206, 306 / Motor 1.6 TU5JP - Gasolina	4	IN	39.30 x 6.97 x 111.50	M/SH	30°	C	C	VA0440575
		EX	31.35 x 6.97 x 111.75	A/M/CP	45°	C	C	VE0440596
Motor 1.4 8v TU3JP - 206, 106, 205 GT/XS, 306, 405, Partner - Flex	4	EX	29.15 x 6.98 x 112.57	M/CP	45°	A	C	VE0440588
Motor 1.4 8v TU3JP - 206, 307 - Flex	4	IN	36.66 x 6.98 x 112.70	M/CP	45°	A	C	VA0441091
		EX	29.15 x 6.98 x 112.57	M/CP	45°	A	C	VE0440588
Motor 1.5 8v TU4M - 208 - Flex	4	IN	37.65 x 5.98 x 112.31	M	Stellite 45°	A	C	VA0441689*
		EX	30.20 x 5.96 x 112.61	A/M	Stellite 45°	A	C	VE0441690*
Motor 1.6 16v TU5JP4 - 206, C3, Picasso, 307 - Gasolina	4	IN	31.30 x 5.98 x 103.80	M	45°	A	C	VA0440578
		EX	24.50 x 5.96 x 104.40	A/M/CP	45°	A	E	VE0440598
Motor 1.6 16v TU5JP4 Aspirado - 2008, 206, 207, 208, 307, 308, Hoggar, Partner, Aircross, C3, C4, Xsara - Flex	4	IN	31.30 x 5.98 x 103.80	M	45°	A	E	VA0441701
		EX	24.50 x 5.96 x 104.40	A/M	45°	A	E	VE0441702
Motor 1.6 16v / 1.9 16v - 405 GR, SR, GL, GE XU5/XU9/ XU5JP, 205 CTI, GTI XU5M/ XU9JA, 305 GT XU92C - Gasolina	4	IN	41.58 x 7.97 x 108.74	M/SH	44°50'	A	A	VA0440551
		EX	34.48 x 7.97 x 108.32	A/M/CP	44°22'	A	A	VE0440585
Motor 1.8 16v XU7JP4 - 306XR, 306XT, 306Break, 405 - Gasolina	4	IN	34.60 x 5.98 x 106.40	M/SH	44°30'	A	A	VA0440561
		EX	29.55 x 5.98 x 105.75	A/M/ST/CP	44°30'	A	A	VE0440297
Motor 1.8 16v XU7JP4 - 406 - Gasolina / Motor 2.0 16v XU10JUR - 406, 306, 605 - Gasolina	4	IN	34.60 x 6.98 x 106.40	M/SH	44°30'	C	C	VA0440571
		EX	29.50 x 6.98 x 105.77	A/M/CP	44°30'	C	C	VE0440590
Motor 1.8 XU7JB - 406, Partner / Motor 1.9 XU9J2 - 504 TI/L/GL, 405 GRI/SRI - Gasolina	4	IN	41.60 x 7.98 x 105.17	M/SH	44°50'	A	A	VA0441040*
		EX	34.50 x 7.97 x 104.75	A/M/ST/CP	44°22'	A	A	VE0441382*
Motor 2.0 16v EW10J4 - 206, 307, 406	4	IN	33.20 x 5.97 x 106.20	M/SH	44°30'	A	C	VA0440579
		EX	29.07 x 5.96 x 103.60	A/M/ST/CP	44°30'	A	A	VE0441603 (VE0440599)
Motor 2.0 16v XU10J4 Injeção - 306, 405 - Gasolina	4	IN	34.60 x 6.98 x 106.20	M	44°45'	C	A	VA0440569
		EX	29.58 x 6.98 x 104.95	A/M/CP	45°	C	A	VE0440301
Motor 2.0 8v e 16v XU10J2 / XU10J2C - 306, 405 - Injeção - Gasolina	4	IN	42.55 x 7.98 x 108.80	M/CP/SH	44°30'	C	A	VA0440557
		EX	34.55 x 7.96 x 108.40	A/M/CP	44°30'	C	A	VE0440589
Motor 2.0 16v EW10A - 307 - 2008-> - Gasolina / Flex	4	IN	33.20 x 5.97 x 106.20	M/SH	44°30'	A	C	VA0440579
		EX	29.07 x 5.96 x 103.60	A/M/ST/CP	44°30'	A	A	VE0441603 (VE0440599)
Motor 2.3 - 504, Indenor XD2 - Diesel	4	EX	33.48 x 8.46 x 116.20	A/CP	45°	A	A	VE0440583
		EX	33.48 x 8.46 x 116.20	A/CP	45°	A	A	VE0440583+04
		EX	33.48 x 8.46 x 116.20	A/CP	45°	A	A	VE0440583+08
Motor 2.3 - 504, Indenor XD2 - Diesel	4	IN	40.48 x 8.48 x 116.20	M	30°	A	A	VA0440566
		IN	40.48 x 8.48 x 116.20	M	30°	A	A	VA0440566+04
		IN	40.48 x 8.48 x 116.20	M	30°	A	A	VA0440566+08
		EX	33.48 x 8.46 x 116.20	A/CP	45°	A	A	VE0440583
		EX	33.48 x 8.46 x 116.20	A/CP	45°	A	A	VE0440583+04
		EX	33.48 x 8.46 x 116.20	A/CP	45°	A	A	VE0440583+08
		EX	33.48 x 8.46 x 116.20	A/CP	45°	A	A	VE0440583+08

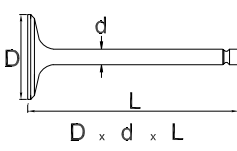
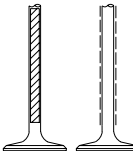
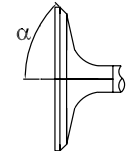

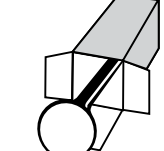
(*) Item sob consulta

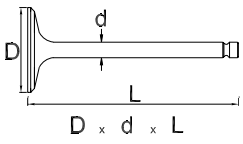
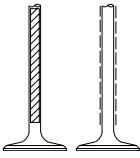
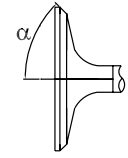

	Nº CIL.	TIPO TYPE						
Motor 2.8 (Iveco) Turbo - Boxer - Diesel	4	IN	40.90 x 7.99 x 120.90	M/CP	30°	A	A	VA0010211
		EX	35.90 x 7.99 x 121.95	A/M/CP	44°30'	A	A	VE0010212
Motor 2.8 (Iveco) Aspirado - Boxer - Diesel	4	IN	43.35 x 7.99 x 121.80	AB/M/CP	60°	A	C	VA0250513
		EX	35.90 x 7.99 x 121.95	A/M/CP	44°30'	A	A	VE0010212
Motor 2.5 Aspirado / Turbo - 504 XD2, 505 XD3 - Diesel	4	IN	42.38 x 8.48 x 115.95	M/CP	45°	A	E	VA0440567
		IN	42.38 x 8.48 x 115.95	M/CP	45°	A	E	VA0440567+04
		IN	42.38 x 8.48 x 115.95	M/CP	45°	A	E	VA0440567+08
		EX	35.38 x 8.46 x 116.15	A/CP	45°	A	A	VE0440581
		EX	35.38 x 8.46 x 116.15	A/CP	45°	A	A	VE0440581+04
		EX	35.38 x 8.46 x 116.15	A/CP	45°	A	A	VE0440581+08

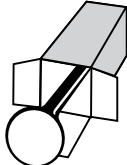
	Nº CIL.	TIPO TYPE						
Motor 1.0 16v D4D - Clio, Twingo, 206 - Gasolina / Flex	4	IN	25.92 x 5.47 x 110.75	M/N	45°	C	A	VA0181606 (VA0180427)
		EX	22.16 x 5.46 x 112.65	A/M/N	45°	C	A	VE0181607 (VE0180438)
Motor 1.0 8v D7D - Clio, Kangoo - Gasolina / Motor 1.1 D7F - Twingo, Clio, Kangoo - Gasolina	4	IN	32.90 x 5.97 x 106.85	M/SH	30°	A	A	VA0180421
			29.85 x 5.96 x 106.70	AB/M	45°	A	A	VE0180422
Motor 1.4 - Trafic / Motor 1.6 - R9, R11, R19, Clio	4	IN	34.08 x 6.98 x 90.68	M/CP	45°	B	C	VA0180389
		EX	28.90 x 6.97 x 88.90	A/M/ST/CP	45°15'	B	C	VE0180305
Motor 1.4 Francês E7J - Clio / Motor 1.6 8v K7M - Megane, Kangoo	4	IN	37.50 x 6.99 x 107.75	M	30°	A	A	VA0180393*
		EX	33.55 x 6.97 x 107.70	A/M/ST	45°	A	A	VE0180310*
Motor 1.6 8v K7M HI-Power - Logan, Sandero, Symbol - Flex	4	IN	37.70 x 6.97 x 108.35	M/N	60°	A	C	VA0181703
		EX	33.60 x 6.96 x 108.35	A/M/N	45°	A	C	VE0181704
Motor 1.6 16v K4M - Clio, Scenic, Megane - Gasolina	4	IN	32.70 x 5.40 x 109.30	M	45°	A	C	VA0180124
		EX	27.90 x 5.40 x 107.60	A/M	45°	C	A	VE0180125
Motor 1.6 16v K4M - Kangoo, Logan, Megane, Oroch, Sandero, Scenic, Symbol - Flex	4	IN	32.70 x 5.50 x 109.45	M/N	45°	A	C	VA0181746*
		EX	28.00 x 5.50 x 107.65	A/M/N	45°	A	C	VE0181747*
Motor 1.8 F3P / 2.0 F3R Injeção - Laguna, Megane - Gasolina	4	IN	40.00 x 7.98 x 115.50	M	45°	A	A	VA0180395
		EX	32.70 x 7.97 x 115.35	A/ST/CP	45°	A	A	VE0180396
Motor 1.8 - R19 - Gasolina	4	IN	40.18 x 7.98 x 107.15	M	44°45'	A	A	VA0180423
		EX	32.48 x 7.97 x 106.90	A/M/ST	45°	A	A	VE0180424
Motor 2.0 16v F4R - Scenic, Megane - Gasolina	4	IN	33.50 x 5.47 x 110.03	M	45°	A	C	VA0180415
			29.00 x 5.45 x 108.90	A/M	44°30'	A	C	VE0180416
Motor 2.0 16v F4R HI-Flex - Duster, Megane, Sandero - Flex	4	IN	34.00 x 5.47 x 110.60	M/N	45°	A	C	VA0181730*
		EX	29.00 x 5.96 x 111.14	AN/M/N	45°	C	C	VE0181731*
Motor 2.0 16v - Fluence - Flex	4	IN	33.92 x 5.47 x 106.23	M/N	44°30'	A	C	VA0031604
		EX	27.80 x 5.46 x 105.25	A/N/ST	44°30'	A	C	VE0031605
Motor 2.5 16v DCI - Master / Motor 2.2 16v / 2.5 16v - Trafic II, Laguna, Laguna Grandtour	4	IN	30.60 x 5.96 x 123.20	M	45°15'	C	C	VA0181483
		EX	29.50 x 5.96 x 123.00	A/M	45°7'	C	C	VE0181484
Motor 2.8 Aspirado - Jumper - Diesel	4	IN	43.35 x 7.99 x 121.80	AB/M/CP	60°	A	C	VA0250513
		EX	35.90 x 7.99 x 121.95	A/M/CP	44°30'	A	A	VE0010212
Motor 2.8 Turbo - Jumper - Diesel	4	IN	40.90 x 7.99 x 120.90	M/CP	30°	A	A	VA0010211
		EX	35.90 x 7.99 x 121.95	A/M/CP	44°30'	A	A	VE0010212

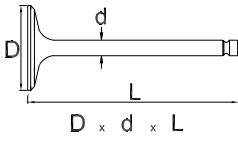
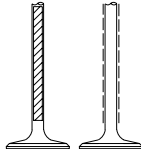
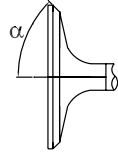

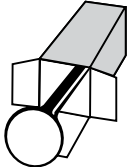
(*) Item sob consulta

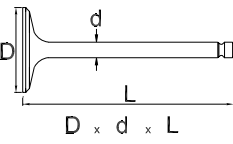
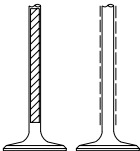
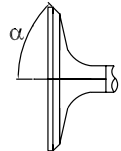

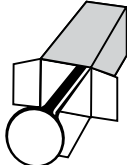
	N° CIL.	TIPO TYPE						
Motor DS9, DSC9	5-6	IN	51.00 x 11.00 x 162.48	A/M	70°30'	A	A	VA0760215
		EX	44.00 x 11.00 x 162.48	A	45°30'	A	A	VE0760216
Motor DC9 5cil Euro 5 - 250cv, 270cv, 310cv / DC11.08 - 340cv / DC12 - Ago/2009-> - Série 4 Evolution 5 / DC13 Serie 5	5-6	IN	44.00 x 9.95 x 171.40	M/X/CP	Stellite 70°30'	D	C	VA0761423
Motor DC9 5cil Euro 5 - 250cv, 270cv, 310cv / DC11.08 - 340cv / DC12 - Ago/2009-> - Série 4 Evolution 5	5-6	EX	41.00 x 9.95 x 171.52	A/M/CP	Stellite 45°30'	D	C	VE0761424
Motor D11 A05/A06/B03/B05/B08/L03/M01 / DS11 A05/A06/L05/M01 / DS14 A01/A03TX/LB05/LB08, DSI14 M01 - Até 1989	6-8	EX	45.00 x 10.90 x 162.50	AN/ST/CP	Stellite 44°30'	G	A	VE0760058
Motor D11 / DS11 / DN11 / DSC11 / DSI11 / DS14 / DSC14 / DSI14 - 1990->	6	EX	44.60 x 10.90 x 162.50	A/CP/ST	Stellite 45°30'	G	A	VE0760012
Motor D11 - L111, B111 - Até 1989	6-8	IN	54.00 x 10.94 x 162.40	M/ST/CP	29°30'	Q	A	VA0761145
		EX	45.00 x 10.90 x 162.50	AN/ST/CP	Stellite 44°30'	G	A	VE0760058
Motor DS11 / DN11 / DSC11 / DSI11 / DS14 / DSC14 / DSI14	6	IN	54.00 x 11.00 x 162.50	A/CP/CS	70°30'	G	A	VA0760013
		EX	44.60 x 10.90 x 162.50	A/CP/ST	Stellite 45°30'	G	A	VE0760012
Motor DS11 / DN11 / DS14 / DSI14 - Até 1989	6-8	EX	45.00 x 10.90 x 162.50	AN/ST/CP	Stellite 44°30'	G	A	VE0760058
Motor Série 4 - DC12 / DSC12 / DC11 / DN12 - Até 1° semestre de 2009	6	IN	44.00 x 10.00 x 171.40	A/CP/M	70°30'	A	A	VA0760103
		EX	41.00 x 9.93 x 171.50	A/CP/M/ST	Stellite 45°30'	A	A	VE0760102
Motor Série 4 - DC12 / DSC12 / DC11 / DN12 - Até 1° semestre de 2009 / Motor DT12 / DC16 - Até Euro 4 / Motor DC9 5cil e 6cil / Motor DC14	5-6	IN	44.00 x 9.94 x 171.09	X/M/CP	19°30'	A	A	VA0760225
		EX	41.00 x 9.93 x 171.50	A/CP/M/ST	Stellite 45°30'	A	A	VE0760102

	N° CIL.	TIPO TYPE						
Motor 125cc - Motocicleta Intruder, Yes, EN - Gasolina	6	IN	54.00 x 11.00 x 162.50	A/CP/CS	70°30'	G	A	VA0760013
			44.60 x 10.90 x 162.50	A/CP/ST	Stellite 45°30'	G	A	VE0760012
Motor DS11 / DN11 / DSC11 / DSI11 / DS14 / DSC14 / DSI14	6	IN	54.00 x 11.00 x 162.50	A/CP/CS	70°30'	G	A	VA0760013
		EX	44.60 x 10.90 x 162.50	A/CP/ST	Stellite 45°30'	G	A	VE0760012

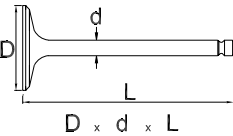
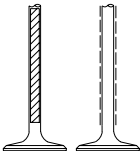
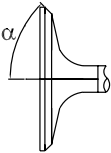

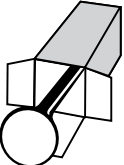
	Nº CIL.	TIPO TYPE						
Motor 1.3 16v e 1.5 16v - Etios - Flex	4	IN	29.00 x 5.48 x 88.37	M/N	44°30'	A	C	VA0631640
		EX	24.23 x 5.48 x 89.22	A/N	44°30'	A	C	VE0631641
Motor 1.8 16v 1ZZ-FE / 1ZZFBE - Corolla - 2002-> - Gasolina / Flex	4	IN	32.00 x 5.50 x 88.52	M/N	45°30'	A	E	VA0630207
		EX	27.45 x 5.50 x 88.68	A/N	45°30'	A	E	VE0630208
Motor 1.8 16v - Corolla - 1998->2001 - Gasolina	4	IN	31.00 x 6.00 x 87.50	M	45°30'	A	E	VA0630205
		EX	24.50 x 6.00 x 87.80	A/ST	45°30'	A	E	VE0630206
Motor 1.8 16v 2ZR-FE - Corolla - Flex	4	IN	32.00 x 5.50 x 109.30	A/N	45°30'	A	C	VA0631738*
		EX	27.54 x 5.50 x 108.30	A/N	45°30'	A	C	VE0631739*
Motor 2.0 16v 3ZRFBE - Corolla - Mar/2010-> - Flex	4	IN	32.00 x 5.48 x 109.30	A/ST/N	45°30'	A	E	VA0631550
		EX	27.54 x 5.47 x 108.30	A/ST/N	45°30'	A	E	VE0631551
Motor 2.0 2L / 2.2 / 2.5 - Hilux - Diesel	4	EX	36.00 x 7.97 x 103.30	A/CP	45°20'	A	A	VE0630241
Motor 2.5 2KDFTV - Hilux - Diesel	4	IN	30.50 x 5.97 x 105.60	M/N	45°30'	A	E	VA0631453
		EX	26.50 x 5.97 x 105.70	A/N	45°30'	A	E	VE0631454
Motor 2.8 3L Aspirado - Hilux - 1988-> - Diesel	4	IN	43.00 x 8.00 x 104.00	M/N	45°35'	A	C	VA0630240
		EX	36.00 x 7.97 x 103.30	A/CP	45°20'	A	A	VE0630241
Motor 3.0 8v 1KZTE - Hilux - Diesel	4	IN	42.50 x 7.99 x 103.60	M/N	45°15'	A	C	VA0630213
			37.00 x 7.96 x 103.20	A/N	45°15'	A	C	VE0630214
Motor 14B 3400cc - Bandeirante, Land Cruiser - Diesel	4	IN	45.90 x 8.97 x 126.50	M/CP	45°	A	A	VA0630259
		EX	38.47 x 8.97 x 126.46	A/M/CP	44°30'	A	A	VE0630260
Empilhadeira 4Y	4	IN	40.00 x 7.98 x 108.26	M/N	45°30'	A	C	VA0631405
		EX	36.00 x 7.98 x 108.50	A/M/N	45°30'	A	C	VE0631406

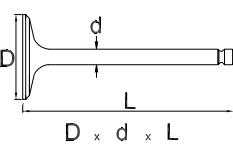
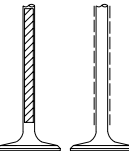
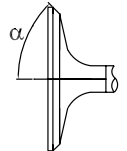

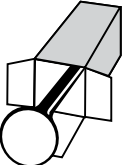
(*) Item sob consulta

	Nº CIL.	TIPO TYPE						
Motor 320 / 420 / 620 - Aspirado / Turbo - Trator 700 / 800	3-4- 6	IN	48.00 x 8.97 x 151.60	M/SH	35°	A	C	VA0310273
		EX	40.93 x 8.92 x 152.76	A/M/CP	45°	A	C	VE0310274

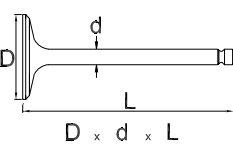
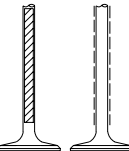
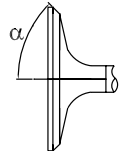

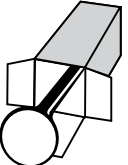
	Nº CIL.	TIPO TYPE						
Motor 1.0 16v AT Aspirado - Gol, Parati - Gasolina	4	IN	22.50 x 5.97 x 98.70	M/SH	44°50'	C	A	VA0700009
		EX	19.97 x 5.95 x 98.15	A/M	Stellite 44°50'	C	A	VE0700008
Motor 1.0 16v EA111 RSH Power - Gol, Parati - Gasolina	4	IN	22.50 x 5.97 x 101.70	M/SH	45°15'	C	A	VA0700074
		EX	20.00 x 5.90 x 101.60	A/M	45°	C	C	VE0700073
Motor 1.0 8v AT - Gol - Gasolina / Álcool	4	IN	30.97 x 6.96 x 94.68	M/SH	44°50'	C	A	VA0700028
		EX	25.97 x 6.94 x 94.33	A/M	Stellite 44°50'	C	A	VE0700027
Motor 1.0 8v EA111 RSH Power - Gol - 2002-> - Gasolina / Álcool / Motor 1.0 8v EA111 / VHT - Gol, Voyage, Fox - Flex / 1.0 8v TEC - Flex	4	IN	31.00 x 5.98 x 99.00	M/N	45°10'	C	C	VA0701421
		EX	26.00 x 5.96 x 99.00	A/M/N	45°10'	C	C	VE0701422
Motor 1.0 / 1.4 - AAU, ABD - Seat Ibiza, Córdoba	4	IN	34.00 x 6.96 x 99.00	M/SH	44°52'	C	A	VA0700758*
		EX	28.90 x 6.94 x 99.00	A/M/ST	44°52'	C	A	VE0701141*
Motor 1.0 12v EA211 CSEZ - Cross Up, Fox, Gol, Polo, Up, Voyage - Flex	3	IN	28.50 x 5.00 x 110.22	M/N	45°	C	C	VA0701740/3*
		EX	27.00 x 5.00 x 110.15	A/M/N	60°	C	C	VE0701741/3*
Motor 1.4 8v EA111 - Kombi - Flex / Motor 1.6 8v EA111 RSH - CrossFox, Gol G5, Golf, Fox, Polo, Saveiro, SpaceFox - Flex	4	IN	34.50 x 6.00 x 99.18	M/N	45°10'	C	C	VA0700267
		EX	28.00 x 6.00 x 99.18	A/M/ST	45°10'	C	A	VE0700268
Motor 1.6 8v EA113 - Golf, Audi A3 - Até 2001 / Motor 2.0 8v Aspirado - Golf, Bora, New Beetle - 1999->	4	IN	39.50 x 6.98 x 91.80	M/SH	45°	C	C	VA0700089
		EX	32.90 x 6.97 x 91.10	A/M	45°	C	A	VE0700190
Motor 1.6 8v EA111 RSH - Golf, Fox, SpaceFox, CrossFox, Polo, Audi A3 - Gasolina	4	IN	34.50 x 5.97 x 99.18	M/SH	45°	C	A	VA0700252
		EX	28.00 x 5.95 x 99.18	A/M	45°	C	A	VE0700253
Motor 1.6 16v EA211 - CrossFox, Fox, Gol, Golf, Polo, Saveiro, SpaceCross, Space Fox - Flex	4	IN	28.50 x 5.00 x 110.22	M/N	45°	C	C	VA0701740/4*
		EX	27.00 x 5.00 x 110.15	A/M/N	60°	C	C	VE0701741/4*
Motor 1.6 CHT / 1.6 AE - Corcel, Escort, Verona - Out/1982->Dez/1996 - Gasolina	4	IN	36.38 x 6.98 x 97.02	M/CP	45°	L	C	VA0590044
Motor 1.8 20v Aspirado / Turbo - Golf GTI, Bora, Passat - Gasolina	4	IN	27.00 x 5.97 x 105.00	M/ST	45°15'	C	C	VA0700242
		EX	29.90 x 5.95 x 104.00	AB/M/ST/CP	45°15'	C	A	VE0700243
Motor 2.0 8v Aspirado - Passat - 1994->1997 - Gasolina	4	IN	39.50 x 6.98 x 91.80	M/SH	45°	C	C	VA0700089
		EX	32.90 x 6.97 x 91.10	A/M	45°	C	A	VE0700190
Motor 2.0 APK (México) - Golf, Bora, New Beetle - Gasolina / Motor 2.0 8v Aspirado CKJA - Jetta - 2011-> - Flex	4	IN	39.50 x 6.98 x 91.80	M/SH	45°	C	C	VA0700089
		EX	32.90 x 7.00 x 91.15	A/M/ST	45°15'	C	C	VE0700220
Motor 2.0 16v TDI / BI TDI - Amarok - Diesel	4	IN	28.00 x 5.98 x 99.50	M	45°	C	A	VA0701558
		EX	26.00 x 5.97 x 99.16	AB/M	45°	C	A	VE0701559
Motor 2.5 20v 150cv - Jetta - Gasolina	5	IN	33.86 x 5.98 x 103.97	M/SH	45°	C	C	VA0701459
		EX	28.00 x 5.97 x 101.88	AN/M/CP	45°	C	A	VE0701460
Motor 1.3 (BY / BM) Refrigerado a Ar - Gasolina / Álcool	4	IN	33.03 x 7.94 x 111.70	M	44°15'	C	C	VA0700050
		EX	30.00 x 7.90 x 111.90	A/M	45°	C	A	VE0700049

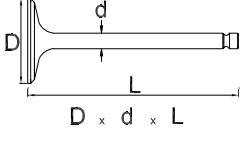
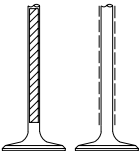
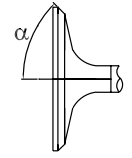

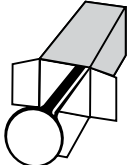
(*) Item sob consulta

	Nº CIL.	TIPO TYPE						
Motor 1.5 / 1.6 / 1.7 - Refrigerado a Ar - Carburado (BP / BG / UA / BX / BH / BR / BI / BL / Kombi) / 1.6 Refrigerado a Ar - Injeção - Kombi - Gasolina / Álcool	4	IN	35.50 x 7.94 x 111.70	M	45°	C	C	VA0700020
		EX	31.88 x 7.93 x 111.90	A/M	45°	C	C	VE0700022
Motor 1.6 Injeção (BY / BM) Refrigerado a Ar - Versão Econômica - Kombi - Gasolina / Álcool	4	EX	30.00 x 8.89 x 111.85	A/M	Stellite 45°	C	A	VE0700021
Motor 1.6 - Kombi, Passat - Diesel	4	IN	34.00 x 7.95 x 104.75	M	45°30'	C	E	VA0700082
		EX	31.08 x 7.94 x 104.45	A/M	Stellite 45°	C	E	VE0700081
Motor 1.5 AP Carburado - 1974->1982 / Motor 1.6 AP Carburado - 1982->1984 - Gasolina / Álcool	4	IN	34.00 x 7.96 x 98.70	M/SH	44°40'	A	C	VA0700061
		EX	31.18 x 7.94 x 98.45	A/M	44°50'	A	A	VE0700062
Motor 1.6 AP Carburado - 1984->1985 / Motor 1.7 - Passat - Gasolina / Álcool	4	IN	34.00 x 8.00 x 98.70	M	45°15'	C	E	VA0700078
		EX	31.10 x 8.00 x 98.50	A/M/ST	Stellite 45.17°	C	E	VE0700077
Motor 1.6 AP Carburado - 1985->1994 / Motor 1.8 AP Carburado / Injeção - 1985->1994 / Motor 2.0 AP Carburado / Injeção - 1988->1990 - Gasolina / Álcool	4	IN	38.00 x 7.96 x 98.70	M/SH	45°50'	C	E	VA0700017
Motor 1.6 AP Carburado - 1985->1994 / Motor 1.8 AP Carburado / Injeção - 1985->1994 / Motor 2.0 AP Carburado / Injeção - 1988->1994 - Gasolina / Álcool	4	EX	33.18 x 7.93 x 98.45	A/M/ST	44°50'	C	A	VE0700016
Motor 1.6 AP Carburado / Injeção - 1994->1997 / Motor 1.8 AP Carburado / Injeção - 1993->1997 - Gasolina / Álcool	4	IN	38.00 x 7.96 x 91.40	M/SH	44°30'	C	C	VA0590066
		EX	33.00 x 7.94 x 90.80	A/M/ST	Stellite 45°10'	C	A	VE0590065
Motor 1.6 AP Injeção - 1996->2008 / Motor 1.8 AP Injeção - 1997->2009 - Gasolina / Álcool / Flex / Motor 2.0 AP Injeção - 1997->2006 - Gasolina / Álcool	4	IN	37.90 x 6.98 x 91.85	M/SH	45°	C	C	VA0700088
		EX	32.90 x 6.96 x 91.15	A/M/ST	Stellite 45°	C	A	VE0700087
Motor 2.0 AP Injeção - 1991->1997 - Gasolina / Álcool	4	EX	33.00 x 7.94 x 90.80	A/M/ST	Stellite 45°10'	C	A	VE0590065
Motor 2.0 AP Injeção - Gol, Parati, Saveiro, Santana - 1997->2006 - Gasolina / Álcool	4	IN	39.50 x 6.98 x 91.80	M/SH	45°	C	C	VA0700089
Motor B 5.9L / BTA 5.9L / BTAA 5.9L - 12170, 16170	4-6	IN	44.98 x 7.97 x 129.05	M/CP	30°	A	A	VA0210151
		EX	42.03 x 7.96 x 128.96	A/CP	45°	A	A	VE0210150
Motor C 8.3L / CT 8.3L / CTA 8.3L / CTAA 8.3L - 14210, 16210, 16170, 24250, 35300	6	IN	52.00 x 9.49 x 151.18	M/CP	60°	A	A	VA0210153
		EX	46.06 x 9.49 x 150.94	A/M/CP	45°	A	A	VE0210152
Motor 6.10 / 6.10T / 6.10TCA - Euro 1 / 2 / 3 - Caminhão Worker 13180, 15180, 17180	6	IN	45.00 x 8.96 x 126.00	CP/M	60°	C	C	VA0130101
		EX	41.00 x 8.96 x 126.00	A/M/ST/CP	45°	C	A	VE0130100
Motor 4.10 / 4.10T / 4.10TCA - Euro 1 / 2 / 3 - 7100, 8100, 8140, 12140	6	IN	45.00 x 8.96 x 126.00	CP/M	60°	C	C	VA0130101
		EX	41.00 x 8.96 x 126.00	A/M/ST/CP	45°	C	A	VE0130100

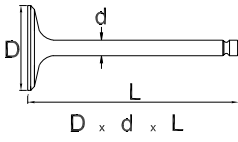
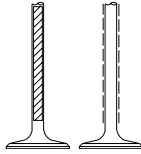
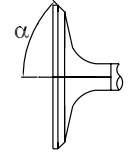
	Nº CIL.	TIPO TYPE						
Motor D11C - B340R, B380R, B420R, B450R, FM370, FMX370	6	IN EX	38.00 x 8.00 x 192.70 40.00 x 8.20 x 191.85	X/M/ST/LCP X/M/ST/LCP	60° 60°	C C	C C	VE0711743* VA0711742*
Motor TD10A / TD100 / THD100E / THD101H / TD102F/FS/FT - D10, N10, NL10, F10, B10R	6	IN EX	49.98 x 10.99 x 167.20 45.98 x 10.97 x 167.15	CP/M A/CP/M/ST	29°30' Stellite 44°30'	A A	A A	VA0710063 VE0710064
Motor D12A - 340cv, 380cv, 420cv - Caminhão FH12 - Diesel - Até 1998	6	EX	40.00 x 7.96 x 191.70	AB/M/CP	45°	A	A	VE0710201
Motor D12A / D12C / D12D - 340cv, 380cv, 420cv - Caminhão FM, NH, FH12 - Até 2003 - Diesel	6	IN	39.90 x 7.97 x 192.30	M/CP	30°	N	A	VA0710203
Motor D12C / D12D - Caminhão FM, FH, NH - 1998->	6	EX	40.00 x 7.96 x 191.70	A/CP/M	45°30'	A	A	VE0710202
Motor D13 Euro 3 / Euro 4 / Euro 5 / MD13 Euro 4	6	IN	42.00 x 7.97 x 191.96	A/CS/CP	Stellite 65°30'	C	C	VA0711398
Motor D13 Euro 4 / Euro 5 / MD13 Euro 4 - FH400, 420, 440, 460, 480, 500, 520, 540, FM400, 440, 480	6	EX	40.00 x 7.97 x 191.78	A/CS/CP	Stellite 50°45'	C	C	"VE0711695 (VE0711399)"
Motor TD120 / TD122F / TD123E/S - Caminhão N12	6	IN EX	53.98 x 10.99 x 167.20 49.93 x 10.97 x 167.15	CP/M A/M/ST/CP	29°30' 44°30'	A A	A A	VA0710121 VE0710120

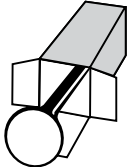
(*) Item sob consulta

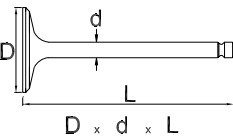
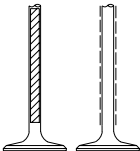
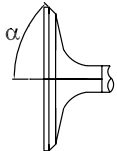
	Nº CIL.	TIPO TYPE						
Motor Mazda FE - Empilhadeira GP / GP25RE / VX	4	IN	33.70 x 5.99 x 103.20	A/N	45°30'	A	C	VA2111419
		EX	28.95 x 5.98 x 103.95	A/N	45°	A	C	VE2111420

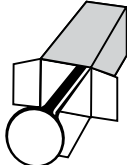
	N° CIL.	TIPO TYPE						
Motor 115cc - Motocicleta Neo - Gasolina	1	IN	23.00 x 4.97 x 66.30	M/N	Stellite 45°15'	A	C	VA0521720*
		EX	20.00 x 4.97 x 65.80	A/M/N	Stellite 45°15'	A	C	VE0521721*
Motor 115cc - Motocicleta Crypton - Gasolina	1	IN	23.00 x 4.47 x 65.35	M/N	45°	A	C	VA0521714*
		EX	20.00 x 4.47 x 64.75	X/M/N	45°	A	C	VE0521715*
Motor 125cc - Motocicleta YBR	1	IN	26.00 x 5.00 x 64.30	M	45°	A	C	VA0520199
		EX	22.00 x 5.00 x 63.50	A/M	45°	A	C	VE0520200
Motor 150cc - Motocicleta Factor, Fazer, XTZ - Flex	1	IN	28.00 x 4.49 x 80.00	M/N	45°	A	C	VA0521712*
		EX	23.60 x 4.46 x 79.50	X/M/N	45°	A	C	VE0521713*
Motor 250cc - Motocicleta Fazer - 2006->2014 - Gasolina	1	IN	34.00 x 5.98 x 93.67	M/N	44°30'	A	A	VA0521673
		EX	28.50 x 5.97 x 92.46	A/M/N	44°30'	A	A	VE0521674
Motor 250cc - Motocicleta Fazer - 2015-> - Flex	1	IN	34.00 x 5.98 x 93.67	A/M/N	44°30'	A	A	VA0521670
		EX	28.50 x 5.97 x 92.46	A/M/ST/N	44°30'	A	A	VE0521671
Motor 660cc - Motocicleta XT - 2005->2015 - Gasolina	1	IN	37.95 x 6.00 x 102.35	M/N	45°15'	A	C	VA0521736*
		EX	32.00 x 6.00 x 95.85	X/M/N	45°15'	A	C	VE0521737*

(*) Item sob consulta

MAHLE	ORIGINAL	TRW	EATON	KS	3B	LINHA MOTORA
VA0010211	7301820	VX 4011 AA			3510-ACB / 3624-AC	IVECO
VA0010211	7301820	VX 4011 AA			3510-ACB / 3624-AC	PEUGEOT
VA0011467	504072531				4246-AC	IVECO
VA0011469	500355778			50.017.897	4094-AC	IVECO
VA0011475	504069199				4112-AC	IVECO
VA0030331	13201-50K00				4028-AN / 4028-AN	NISSAN
VA0031570	13201-CP50A				4134-A	NISSAN
VA0031604	13201-4589R					RENAULT
VA0031608	13201-3AC0A					NISSAN
VA0031617 (VA0031506)	13201-AD210 (13201-5X00B)				4136-A	NISSAN
VA0060902	7004.00600500.8					AGRALE
VA0060903	7006.00600500.3				3326-A	AGRALE
VA0060904	7007.00600500.1				3924-A	AGRALE
VA0110140	8H-1993		VS-0696			CATERPILLAR
VA0110143	5S-6452		VS-0969		573-A / 1573-ABS	CATERPILLAR
VA0110145	6N-9915		VS-2401		3210-A	CATERPILLAR
VA0110232	7W-8064		VS-3124		3614-AC	CATERPILLAR
VA0110232	7W-8064		VS-3124		3614-AC	GENERAL MOTORS
VA0110235	9L-7682				561-A	CATERPILLAR
VA0111407	1456855					CATERPILLAR
VA0111409	5I-7738					CATERPILLAR
VA0111411	1632442					CATERPILLAR
VA0111413	2102542					CATERPILLAR
VA0111415	2335469					CATERPILLAR
VA0130011	9.2260.460.0054	VX 0304 AA	VS-1134	50.017.717	565-AC	FORD
VA0130011	9.2260.460.0054	VX 0304 AA	VS-1134	50.017.717	565-AC	MWM
VA0130099	622804603014	VX 0692 AA	VS-2696	50.017.767	3390-AC	MWM
VA0130101	9.610.0.460.003.4	VX 2123 AA	VS-2825	50.017.844	3422-AC	MWM
VA0130101	9.610.0.460.003.4	VX 2123 AA	VS-2825	50.017.844	3422-AC	VOLKSWAGEN
VA0130277	9.4070.460.0034				3546-AC	GENERAL MOTORS
VA0130277	9.4070.460.0034				3546-AC	MWM
VA0130933	9.6120.460.0024					MWM
VA0131750	7006680C1E / 21299686					MWM
VA0140015	90323518 / 642763	VX 2332 AA	VS-4261	50.017.754	3136-AC / 4004-AC	GENERAL MOTORS
VA0140026	93248325	VX 2996 AA			3578-AC	GENERAL MOTORS
VA0140040	90220119	VX 1699 AA	VS-1980	50.017.752	3109-AC / 4056-AC	GENERAL MOTORS
VA0140041	52285384	VX 2034 AA	VS-1660	50.017.753	3045-ECP / 3110-AC	GENERAL MOTORS
VA0140072	90412277 / 641022	VX 2909 AA	VS-5094	50.004.483	3140-AC / 3774-AC	GENERAL MOTORS
VA0140076	90412712	VX 2463 AA	VS-4901	50.017.837	3138-AC	GENERAL MOTORS
VA0140084	94621104/ 1038	VX 1550 AA	VS-1299	50.017.710	332-AC	GENERAL MOTORS
VA0140084 0,076	94621039/ 1040				332-AC+3	GENERAL MOTORS
VA0140084 0,127					332-AC+5	GENERAL MOTORS
VA0140084 0,152	94621041				332-AC+06	GENERAL MOTORS
VA0140084 0,254					332-AC+10	GENERAL MOTORS
VA0140084 0,304	94621607				332-AC+12	GENERAL MOTORS
VA0140084 0,381					332-AC+15	GENERAL MOTORS
VA0140084 0,508					332-AC+20	GENERAL MOTORS
VA0140084 0,762					332-AC+30	GENERAL MOTORS
VA0140086	7083246 / 90215492	VX 2331 AA	VS-4899	50.017.835	3146-AC / 3912-AC	FIAT

MAHLE	ORIGINAL	TRW	EATON	KS	3B	LINHA MOTORA
VA0140086	90215492 / 7083246	VX 2331 AA	VS-4899	50.017.835	3146-AC / 3912-AC	GENERAL MOTORS
VA0140104	2638552 / 3774052	VX 0220 AB	VS-1202	50.017.701	137-A / 137-AG	GENERAL MOTORS
VA0140106	3695455 / 3758810	VX 0013 AA	VS-0040	50.017.700	135-A	GENERAL MOTORS
VA0140108	2787538 / 3786360	VX 0221 AA +3	VS-865	50.017.702	137-A+3 / 137-AG+3	GENERAL MOTORS
VA0140110	3786361 / 3995685	VX 0222 AA +15	VS-866	50.017.703	137-A+15 / 137-AG+15	GENERAL MOTORS
VA0140114	90136614 / 6613	VX 1220 AA	VS-1415	50.017.713	344-AC / 3108-AC	GENERAL MOTORS
VA0140114 0,076	90136615				344-AC+3	GENERAL MOTORS
VA0140114 0,381	90136616				344-AC+15	GENERAL MOTORS
VA0140114 0,762	90136617				344-AC+30	GENERAL MOTORS
VA0140183	10241743				3164-AC / 487-AC	GENERAL MOTORS
VA0140226	93333561	VX 3176 AA			4054-AC	GENERAL MOTORS
VA0141396	93399245	V75591A0			4006-AC	GENERAL MOTORS
VA0141431	93361392					GENERAL MOTORS
VA0141575	12615936					GENERAL MOTORS
VA0141579	55569449					GENERAL MOTORS
VA0141581	55570710					GENERAL MOTORS
VA0141705	93382956					GENERAL MOTORS
VA0141708	55599817					GENERAL MOTORS
VA0180124	7701471378 / 7700107602	VX 3101 AA			3598-A	RENAULT
VA0180389	7702220678				3308-AC	RENAULT
VA0180393	8200708663			50.017.935	3526-A / 4184-AN	RENAULT
VA0180395					3714-A / 3716-AC	RENAULT
VA0180415	7701471279				3864-A	RENAULT
VA0180421	7701469266				3620-A	RENAULT
VA0180423	7700855926				3452-A	RENAULT
VA0181483	7701472669				4080-AN / 421-A	RENAULT
VA0181606 (VA0180427)	13201-00Q0H / 7701472986				3862-A	NISSAN
VA0181606 (VA0180427)	7701472986 / 13201- 00Q0H				3862-A	RENAULT
VA0181703	6001552205					RENAULT
VA0181730	132010427R					RENAULT
VA0181746	7701472124					RENAULT
VA0210147	135957				420-A	CUMMINS
VA0210151	3920867 / 3802355		VS-4307		3466-AC / 3466-AC C/O	CUMMINS
VA0210151	3920867 / 3802356		VS-4307		3466-AC / 3466-AC C/O	FORD
VA0210151	3920867 / 3802356		VS-4307		3466-AC / 3466-AC C/O	VOLKSWAGEN
VA0210153	3924492 / 3802463		VS-4309		3334-AC	CUMMINS
VA0210153	3924492 / 3902253		VS-4309		3334-AC	FORD
VA0210153	3924492 / 3802463		VS-4309		3334-AC	VOLKSWAGEN
VA0210237	3418020 / 3068828 / 3800638					CUMMINS
VA0210442	3940735		VS-5102		3976-AC	CUMMINS
VA0210446	3801356 / 3033234					CUMMINS
VA0211371	3942588 / 3800340				4024-AC	CUMMINS
VA0211427	4089761					CUMMINS
VA0211465	3803515					CUMMINS
VA0211732	BH5T-6507-AA					CUMMINS
VA0230119	800558	VX 0023 AA	VS-0016	50.017.759	3272-A	FORD WILLEYS
VA0250002	43401180	VX 0514 AB	VS-992	50.017.170	380-AC	FIAT

MAHLE	ORIGINAL	TRW	EATON	KS	3B	LINHA MOTORA
VA0250018	46470637 / 46559031	VX 2028 AA	VS-4897	50.017.756	3234-AC	FIAT
VA0250052	7722907	VX 2607 AA	VS-4530	50.017.761	3320-AC	FIAT
VA0250054	7617500	VX 2399 AA	VS-2692	50.017.720	856-AC / 855-AC	FIAT
VA0250060	4239917 / 4460697	VX 2220 AA	VS-2556	50.017.714	175-AC / 383-AC	FIAT
VA0250159	7547400	VX 2047 AB	VS-2873	50.017.745	1826-AC	FIAT
VA0250160	7735898	VX 4000 AA			3600-AC	FIAT
VA0250162	46553046	VX 3128 AA	VS-5087		3800-AC	FIAT
VA0250165		VX 4004 AA		50.017.869	3514-AC	FIAT
VA0250166	46553048		VS-5085		3558-AC / 3998-AC	FIAT
VA0250168	60811153 / 7766564	VX 4002 AA			3736-AC	ALFA ROMEO
VA0250168	60811153 / 7766564	VX 4002 AA			3736-AC	FIAT
VA0250271	55195497	V76562A0			3956-AC	FIAT
VA0250513	98468338				3586-ACB	CITROËN
VA0250513	98468338				3586-ACB	FIAT
VA0250513	98468338				3586-ACB	IVECO
VA0250513	98468338				3586-ACB	PEUGEOT
VA0250513	98468338				3586-ACB	RENAULT
VA0251610	55224590				4154-AC	FIAT
VA0251614	7085036 / 90232975 / 93399246				3912-AC	FIAT
VA0251632	55240709					FIAT
VA0251633	55219002				4156-AC / 4256-AC	FIAT
VA0310273	836646356					VALMET / VALTRA
VA0380226	675046-C4					INTERNATIONAL
VA0380228	676687-C4					INTERNATIONAL
VA0380231	1818580-C1					INTERNATIONAL
VA0381304	1823875-C1				3968-AC	INTERNATIONAL
VA0381699	2U2109601A / 1.839.968-C1					INTERNATIONAL
VA0430546	R-98062				3618-AC	JOHN DEERE
VA0430546 0,381	R-97490					JOHN DEERE
VA0440551	9153501780				3301-AC / 3304-A	CITROËN
VA0440551	9153501780				3301-AC / 3304-A	PEUGEOT
VA0440557	094866 / 9605936180				3542-A	PEUGEOT
VA0440561	094892 / 9628943380				3540-A	PEUGEOT
VA0440566	7932582418				381-AC / 381-AC C/O	PEUGEOT
VA0440566+04					381-AC+0,4	PEUGEOT
VA0440566+08					381-AC+0,8	PEUGEOT
VA0440567	9350111580/ 480				3241-AC / 3241- AC C/O	GENERAL MOTORS
VA0440567	9350111580/ 480				3241-AC / 3241- AC C/O	PEUGEOT
VA0440567+04					3241-AC+0,4	GENERAL MOTORS
VA0440567+04					3241-AC+0,4	PEUGEOT
VA0440567+08					3241-AC+0,8	GENERAL MOTORS
VA0440567+08					3241-AC+0,8	PEUGEOT
VA0440569	094861 / 9626052980				3576-A	PEUGEOT
VA0440571	96172597					CITROËN
VA0440571	96172597					PEUGEOT
VA0440572	97531079				4034-AN	CITROËN
VA0440572	97531079				4034-AN	PEUGEOT
VA0440575	96101886 / 96183535				4010-A	CITROËN
VA0440575	96101886 / 96183535				4010-A	PEUGEOT
VA0440578	0948A9				3616-A	CITROËN
VA0440578	0948A9				3616-A	PEUGEOT
VA0440579	0948.99 / 0948.F4				3884-A	CITROËN

MAHLE	ORIGINAL	TRW	EATON	KS	3B	LINHA MOTORA
VA0440579	0948.99 / 0948.F4				3884-A	PEUGEOT
VA0441040	9153501680					PEUGEOT
VA0441091	094891				3798-A / 3242-A	PEUGEOT
VA0441689	9675424780					CITROËN
VA0441701	9805490080					CITROËN
VA0441701	9805490080					PEUGEOT
VA0461693	07W109601					MAN
VA0461734	2V5109601					MAN
VA0480004	3520530101	VX 0246 AE	VS-1177	50.017.042	226-AC / 226-AC C/O	MERCEDES-BENZ
VA0480006	3760530101	VX 2388 AA	VS-1814	50.017.391	3260-ACB / 3260-ACB 20 C/O / 2026-AC 30 C/O	MERCEDES-BENZ
VA0480006+04					3260-ACB+0,4	MERCEDES-BENZ
VA0480006+08					3260-ACB+0,8	MERCEDES-BENZ
VA0480007	366.050.1226	VX 2811 AA	VS-2770	50.017.794	3260-ACB-20° / 3260-ACB C/O	MERCEDES-BENZ
VA0480048	3460530001	VX 0383 AA	VS-1157	50.017.044	229-AC / 229-AC C/O	MERCEDES-BENZ
VA0480048+04					229-AC+0,4	MERCEDES-BENZ
VA0480048+08					229-AC+0,8	MERCEDES-BENZ
VA0480056	4220500226 / 4420500526	VX 2387 AA	VS-2520	50.017.046	1839-ACB / 1839-ACB C/O	MERCEDES-BENZ
VA0480080	3450537001	VX 1565 AA	VS-1129	50.017.757	843-AC / 3262- AC / 3262-AC C/O	MERCEDES-BENZ
VA0480080+04					843-AC+0,4	MERCEDES-BENZ
VA0480080+08					843-AC+0,8	MERCEDES-BENZ
VA0480091	3550530001	VX 0846 AA	VS-1136	50.017.119	3262-AC / 843- AC / 843-AC C/O	MERCEDES-BENZ
VA0480096	3760530001	VX 2390 AA (VA1648A)	VS-2587	50.017.389	2026-AC 30°	MERCEDES-BENZ
VA0480096+04					2026-AC 30° +0,4	MERCEDES-BENZ
VA0480096+08					2026-AC 30° +0,8	MERCEDES-BENZ
VA0480193	5410500226		VS-5037		3856-AC / 4096- AC	MERCEDES-BENZ
VA0480233	6110530101				3658-AN / 4334- AN	MERCEDES-BENZ
VA0480244	9060500326	VX 3004 AB			3846-AC	MERCEDES-BENZ
VA0481436	A5410530101					MERCEDES-BENZ
VA0481563	A6510530101					MERCEDES-BENZ
VA0510029	14711-KYO-8901-R	VX 2324 AA	VS-4993	50.017.774	3416-AC	HONDA
VA0510045	14711-383-000	VX 0786 AA	VS-4906	50.017.778	23293-AP	HONDA
VA0510070	14711-KW1-9000-R	VX 2009 AA	VS-4995	50.017.785	1001-AC	HONDA
VA0510115	14711-440-0030-BR	VX 0989 AA	VS-4985		3408-AC	HONDA
VA0510116	14711-397-6300	VX 1473 AA	VS-4917	50.017.772	3408-AC	HONDA
VA0510126	14711-GN5-9130	VX 3043 AA		50.017.464	1010-A	HONDA
VA0510128	14711-KPF-9000-RW1	VX 3131 AA			3952-AN	HONDA
VA0510130	14711-428-000		VS-5000	50.017.771	3406-AN	HONDA
VA0510132	14711-KGO-000		VS-5002	50.017.773	3410-ANS / 3410-AN	HONDA
VA0510134	14711-KL3-670		VS-5004	50.017.843	3418-ACS	HONDA
VA0510191	14711-413-000		VS-5006	50.017.743	1647-AB	HONDA
VA0510195	14711-KGA-B000-R	VX 3207 AA			3838-AN	HONDA
VA0510197	14711-KRM-8400	VX 3273 AA			3904-AC	HONDA
VA0510209	14711-PO8000				3854-AN / 3432- A	HONDA
VA0510227	14711-KSS-9000	VX 3204 AA			4066-A	HONDA

MAHLE	ORIGINAL	TRW	EATON	KS	3B	LINHA MOTORA
VA0510257	14711-RNA-A00			50.017.930		HONDA
VA0510263	14711-PWA-000			50.017.926	4164-AN	HONDA
VA0510265	14711-PWC-000			50.017.928		HONDA
VA0510269	14711-KCY-670					HONDA
VA0511425	14711-KVS-900					HONDA
VA0511477	14711-KWG-600					HONDA
VA0511628	14711-MAL-600					HONDA
VA0511630	14711-MFJ-D00					HONDA
VA0511634	14711-KBB-900					HONDA
VA0511696	14711-KRE-G00					HONDA
VA0511710	14711-GFM-900					HONDA
VA0511724	14711KWB600					HONDA
VA0511726	14711K70600					HONDA
VA0511744	14711K31900					HONDA
VA0520199	5HH-12111-00	VX 3285 AA			3950-AN	YAMAHA
VA0521670	44C-12111-01					YAMAHA
VA0521673	1S4E-E2111-00					YAMAHA
VA0521712	1ST-E2111-00					YAMAHA
VA0521714	5D9-E2111-10					YAMAHA
VA0521720	BRA0007600					YAMAHA
VA0521736	5VK1211100					YAMAHA
VA0570024	31431315	VX 0602 AA	VS-1160	50.017.792	249-AC	GENERAL MOTORS
VA0570024	31431315	VX 0602 AA	VS-1160	50.017.792	249-AC	PERKINS (MAXION)
VA0570032	70910001/4	VX 0256 AA	VS-887	50.017.704	247-A C/P	PERKINS (MAXION)
VA0570033	0910030 / 0910069	VX 0090 AA	VS-1754	50.017.707	250-AMF / 250-A	FORD
VA0570033	0910030 / 0910069	VX 0090 AA	VS-1754	50.017.707	250-AMF / 250-A	PERKINS (MAXION)
VA0570035	31431261 / 0910001	VX 0092 AB	VS-620		247-A / 247-A C/O	PERKINS (MAXION)
VA0570035+04					247-A+0.4	PERKINS (MAXION)
VA0570035+08					247-A+0.8	PERKINS (MAXION)
VA0570038	70910017	VX 1912 AA	VS-2815	50.017.769	3392-AC / 249- AC C/O	GENERAL MOTORS
VA0570038	70910017	VX 1912 AA	VS-2815	50.017.769	3392-AC / 249- AC C/O	PERKINS (MAXION)
VA0570111	31431723 / 70910011	VX 0440 AA	VS-1423	50.017.739	1498-ACP / 1498-ACP C/O	FORD
VA0570111	31431723 / 70910011	VX 0440 AA	VS-1423	50.017.739	1498-ACP / 1498-ACP C/O	PERKINS (MAXION)
VA0570123	70910025/ 35	VX 2299 AA	VS-2831	50.017.894	3342-AC	GENERAL MOTORS
VA0570123	70910025/ 35	VX 2299 AA	VS-2831	50.017.894	3342-AC	PERKINS (MAXION)
VA0570231	70910081				3858-ACB	FORD
VA0570231	70910081				3858-ACB	PERKINS (MAXION)
VA0570250	70910053				3344-ACB	FORD
VA0570250	70910053				3344-ACB	GENERAL MOTORS
VA0570250	6010531901				3344-ACB	MERCEDES-BENZ
VA0570250	70910053				3344-ACB	PERKINS (MAXION)
VA0570657	70910096 (70910037)				3388-ACB	GENERAL MOTORS
VA0570657	70910096 (70910037)				3388-ACB	PERKINS (MAXION)
VA0571369	70910061					PERKINS (MAXION)
VA0590043	84AU-6507-A	VX 1320 AA	VS-2489	50.017.747	3036-A	FORD
VA0590044	84AU-6507-B / 0291096011	VX 1321 AA	VS-1492	50.017.797	814-AC / 816-AC	FORD
VA0590044	84AU-6507-B / 0291096011	VX 1321 AA	VS-1492	50.017.797	814-AC / 816-AC	VOLKSWAGEN
VA0590066	035109601G	VX 1812 AB	VS-4762	50.017.826	3312-A	FORD
VA0590066	035109601G	VX 1812 AB	VS-4762	50.017.826	3312-A	VOLKSWAGEN
VA0590067	026109601D	VX 1947 AA	VS-2639		3602-A	FORD
VA0590067	026109601D	VX 1947 AA	VS-2639		3602-A	VOLKSWAGEN
VA0590093	59112	VX 0250 AA	VS-1205	50.017.749	3038-A	FORD

MAHLE	ORIGINAL	TRW	EATON	KS	3B	LINHA MOTORA
VA0590094	78MU-6507-A	VX 0756 AA	VS-1132	50.017.708	326-A	FORD
VA0590170	XS6E6507AA	V76175A0			3062-AC	FORD
VA0590172	89BM-6507AA	VX 4009 AA			3054-AC	FORD
VA0590174		V74469A0	VS-4939		3092-AC	FORD
VA0590179	97MM6507BB2B	VX 4006 AA		50.017.870	3064-AC / 3090-AC	FORD
VA0590180	928M-650-F2-A		VS-5294		3066-AC / 3814-AC / 3082-AC / 3068-AC	FORD
VA0590181	89BM-6507AA	V76175A0		50.017.854	3052-AC	FORD
VA0590221	2L2Z-6507-BA					FORD
VA0590255	1S7Z-6507-AA				3094-AC / 3068-AC	FORD
VA0590275					3042-AC	FORD
VA0591461	F57Z-6507-A				3070-AC	FORD
VA0591471	1S4G-6507-CB				4344-AN	FORD
VA0591473	YS4E-6507-AB					FORD
VA0591474	AS65-6507-AA					FORD
VA0591722	CM5Z/6507/A					FORD
VA0630205	13711-15090				3974-AN	TOYOTA
VA0630207	13711-22030					TOYOTA
VA0630213	13711-0L020				4016-AN	TOYOTA
VA0630240	13711-17010				3778-AN / 4038-AN	TOYOTA
VA0630259	13711-58021				3892-AN	TOYOTA
VA0631405	137117601271					TOYOTA
VA0631453	13711-0L010 / 13711-30040				4018-AN	TOYOTA
VA0631550	13711-37030					TOYOTA
VA0631640	13711-47020					TOYOTA
VA0631738	1371137031					TOYOTA
VA0700009	036.109.601.R	VX 2875 AA	VS-5127	50.017.860	3508-A	VOLKSWAGEN
VA0700017	035.109.601.C	VX 1368 AA	VS-1646	50.017.396	815-AC	VOLKSWAGEN
VA0700020	040.109.601.2	VX 0434 AG	VS-869	50.017.716	452-A / 453-A	VOLKSWAGEN
VA0700028	030.109.601.AC	VX 2930 AA	VS-4919	50.017.849	3512-A	VOLKSWAGEN
VA0700050	040.109.601.1	VX 0435 AF	VS-868	50.017.715	422-A / 452-A	VOLKSWAGEN
VA0700061	056.109.601.A	VX 0428 AF	VS-981	50.017.392	422-AC / 422-A	VOLKSWAGEN
VA0700074	036.109.601.AE	VX 3090 AA			3870-A	VOLKSWAGEN
VA0700078	049.109.601.F	VX 1202 AA	VS-1356	50.017.385	825-A	VOLKSWAGEN
VA0700082	068.109.601.C	VX 1210 AA	VS-1358	50.017.016	303-AC	VOLKSWAGEN
VA0700088	048.109.601.E	VX 2923 AA	VS-4510	50.004.599	3484-AB / 815-A / 3484-A / 3486-A / 3238-A / 3310-A	VOLKSWAGEN
VA0700089	078.109.601.B	VX 2975 AA	VS-4546	50.004.600	1718-A / 3486-A / 3313-A	VOLKSWAGEN
VA0700242	058.109.601.C			50.004.507	3488-AS	AUDI
VA0700242	058.109.601.C			50.004.507	3488-AS	VOLKSWAGEN
VA0700252	032.109.601.M	VX 3066 AA	VS-4893	50.017.846	3886-A	VOLKSWAGEN
VA0700267	032.109.601.P	V75152A0				VOLKSWAGEN
VA0700758	030.109.601.G				3972-A	SEAT
VA0700758	030.109.601.G				3972-A	VOLKSWAGEN
VA0701421	030.109.601.AS	V75154A0			3868-A	VOLKSWAGEN
VA0701459	06D.109.601K					VOLKSWAGEN
VA0701558	03L.109.601				4104-A	VOLKSWAGEN
VA0701740/3	04C109601B					VOLKSWAGEN
VA0701740/4	04C109601B					VOLKSWAGEN
VA0710063	469240 / 4675002 / 8194223	VX 0588 AB	VS-4934	50.017.126	860-AC / 860-AC C/O	VOLVO

MAHLE	ORIGINAL	TRW	EATON	KS	3B	LINHA MOTORA
VA0710121	468302	VX 1594 AA	VS-4937	50.017.124	582-AC	VOLVO
VA0710203	1547492	VX 4017 AA	VS-5143	50.017.689	3914-ACB / 4092-ACB	VOLVO
VA0711398	20740798				4218-AX	VOLVO
VA0711742	20737856					VOLVO
VA0720154				50.017.857	3296-AN	ASIA MOTORS
VA0720156					455-A	ASIA MOTORS
VA0760013	352211 / 352212 / 294674 / 289483	VX 1784 AA	VS-4905	50.017.789	1374-ACB 20° / 23394-ACBS / 23394-ACB	SCANIA
VA0760103	1515743 / 1333230	VX 2750 AA		50.009.016	3662-ACB / 3663-ECBS / 4242-AX	SCANIA
VA0760215	1319081				3802-ACB	SCANIA
VA0760225	1785076					SCANIA
VA0761145	237959 / 272803					SCANIA
VA0761423	1887056			50.017.087		SCANIA
VA1401226	11341739820/ 822				4026-AN	BMW
VA1950223	MD198404				3720-AN	MITSUBISHI
VA1950234	MD-088811					MITSUBISHI
VA1950236	ME-203101				4310-AN	MITSUBISHI
VA1950247	ME-202687				3580-AN	MITSUBISHI
VA1950261	MD-159502				3464-AN	MITSUBISHI
VA1950825	MD-085253				4032-AN	MITSUBISHI
VA1951571	MD-162422					MITSUBISHI
VA1961403	87802264					CASE
VA2080849	22211-42520				3896-AN / 3594- AN	HYUNDAI
VA2081301	22211-42220				4170-AN	HYUNDAI
VA2081417	22211-23600					HYUNDAI
VA2081417	22211-23600					KIA MOTORS
VA2081552	22211-2B400					HYUNDAI
VA2081552	22211-2B400					KIA MOTORS
VA2081664	22211-04000					HYUNDAI
VA2081664	22211-04000					KIA MOTORS
VA2081728	222112E400					HYUNDAI
VA2110185	ON01-12-111		VS-5281	50.017.850	3548-APN / 3826-AN	KIA MOTORS
VA2110185	ON01-12-111		VS-5281	50.017.850	3548-APN / 3826-AN	MAZDA
VA2110187	OK65D12111		VS-5296		3828-AN	KIA MOTORS
VA2110229	K710-12-111		VS-5284	50.017.866	3298-AN	KIA MOTORS
VA2110229	K710-12-111		VS-5284	50.017.866	3298-AN	MAZDA
VA2111419	OK 9541 2111					HYSTER
VA2111419	OK 9541 2111					KIA MOTORS
VA2111419	OK 9541 2111					YALE
VA2111594	22211-4A061					HYUNDAI
VA3481577	372-1007011					CHERY
VA3551556	1003012GG013					JAC MOTORS
VA5081716	12911-12F60					SUZUKI
VA5081718	12911-20E00-000					SUZUKI
VA5511554	14711-RC0-M00				4166-AN	HONDA
VA5511568	14711-RNE-A00					HONDA
VA5511748	14711R1ZA00					HONDA
VC0060905	7008.00600500.9					AGRALE
VC0481344	A9060160791				3874-EC	MERCEDES-BENZ
VC0481345	A5410160791				3875-EC	MERCEDES-BENZ
VC0481565	A4420160391				3693-E	MERCEDES-BENZ

MAHLE	ORIGINAL	TRW	EATON	KS	3B	LINHA MOTORA
VE0010212	99432837EC54-0652	VX 4014 AA			4041-ECB / 3587-ECB / 3625-EC	IVECO
VE0010212	99432837EC54-0652	VX 4014 AA			4041-ECB / 3587-ECB / 3625-EC	PEUGEOT
VE0011468	504081062				4247-EC	IVECO
VE0011470	504293892			50.017.898	4095-ECB	IVECO
VE0011616	504378070				4113-EC	IVECO
VE0031124	13202-50K02				4029-EPN	NISSAN
VE0031605	13202-EN20B / 13202-0970R				4135-EN	NISSAN
VE0031605	13202-0970R / 13202-EN20B				4135-EN	RENAULT
VE0031609	13202-3HC0A					NISSAN
VE0031618 (VE0031507)	13202-AD200 (13202-5X00B)				4137-EN	NISSAN
VE0060323	7006.00600600.1				3327-E	AGRALE
VE0060906	7004.00600600.6					AGRALE
VE0060907	7007.00600600.9				3925-E	AGRALE
VE0110141	8H-1994		VS-460			CATERPILLAR
VE0110142	5S-6449		VS-968		573-E	CATERPILLAR
VE0110144	8N-0875		VS-1406		1573-EBS	CATERPILLAR
VE0110146	6N-9916/ 1487455		VS-2402		23210-EBS	CATERPILLAR
VE0110233	136-0819		VS-3140		3615-EC	CATERPILLAR
VE0110233	136-0819		VS-3140		3615-EC	GENERAL MOTORS
VE0110234	9L-7683				1561-EB	CATERPILLAR
VE0111243	7N-0573					CATERPILLAR
VE0111408	1456857					CATERPILLAR
VE0111410	5I-7739					CATERPILLAR
VE0111412	1883122					CATERPILLAR
VE0111414	2102529					CATERPILLAR
VE0111416	2335470					CATERPILLAR
VE0130010	9.3080.460.0024	VX 0305 AA	VS-1135	50.017.199	1565-ECB / 3045-ECP / 1565-ECP	FORD
VE0130010	9.3080.460.0024	VX 0305 AA	VS-1135	50.017.199	1565-ECB / 3045-ECP / 1565-ECP	MWM
VE0130098	9.229.0.460.003.4	VX 1975 AA	VS-2695	50.017.768	3391-ECB	MWM
VE0130100	9.610.0.460.002.4	VX 2124 AA	VS-2824	50.017.844	23423-ECBS / 23423-ECB	MWM
VE0130100	9.610.0.460.002.4	VX 2124 AA	VS-2824	50.017.844	23423-ECBS / 23423-ECB	VOLKSWAGEN
VE0130239	9.612.0.460.001.4 / 9.612.8.460.001.4					MWM
VE0130278	9.4070.460.0024				3547-ECBS / 3547-ECB	GENERAL MOTORS
VE0130278	9.4070.460.0024				3547-ECBS / 3547-ECB	MWM
VE0131751	7006681C1E / 21299685					MWM
VE0140014	90.323.523 / 642890	VX 2333 AA	VS-4262	50.017.755	3137-ECB / 4005-EC / 3137- E	GENERAL MOTORS
VE0140025	93248326	VX 2997 AA			3579-ECB / 3579-EC	GENERAL MOTORS
VE0140039	90323756	VX 2059 AA	VS-1984	50.017.791	23109-ECP / 23109-EC / 4031- EPN / 4057-EX	GENERAL MOTORS

MAHLE	ORIGINAL	TRW	EATON	KS	3B	LINHA MOTORA
VE0140071	90410813 / 641325	VX 2274 AA	VS-5086	50.004.484	23141-ECBS / 23141-EC / 3775- ECBS	GENERAL MOTORS
VE0140075	90412974	VX 2925 AA		50.017.838	3139-EC	GENERAL MOTORS
VE0140083	94621105/ 1043	VX 0365 AC	VS-1302	50.017.732	1332-ECP	GENERAL MOTORS
VE0140083 0,076	94621045				1332-ECP+3	GENERAL MOTORS
VE0140083 0,127					1332-ECP+5	GENERAL MOTORS
VE0140083 0,152	94621047				1332-ECP+06	GENERAL MOTORS
VE0140083 0,254					1332-ECP+10	GENERAL MOTORS
VE0140083 0,304	94621609				1332-ECP+12	GENERAL MOTORS
VE0140083 0,381					1332-ECP+15	GENERAL MOTORS
VE0140083 0,508					1332-ECP+20	GENERAL MOTORS
VE0140083 0,762					1332-ECP+30	GENERAL MOTORS
VE0140085	90324412	VX 2334 AA	VS-4900	50.017.836	3147-ECB	GENERAL MOTORS
VE0140105	3724778 / 3989084	VX 0219 AB - STD	VS-1201	50.017.721	1138-EG / 1138- E / 1138-E STD	GENERAL MOTORS
VE0140107	3732758	VX 0238 AA +3	VS-1335	50.017.722	1138-EG+3	GENERAL MOTORS
VE0140109	7323108 / 3995603	VX 0239 AA +15	VS-1481	50.017.723	1138-EG+15	GENERAL MOTORS
VE0140113	90136620/ 6621	VX 1221 AA / VX 2034 AA	VS-1658	50.017.736	1344-ECP / 23108-ECPS	GENERAL MOTORS
VE0140113 0,076	90136622				1344-ECP+3	GENERAL MOTORS
VE0140113 0,381					1344-ECP+15	GENERAL MOTORS
VE0140113 0,762	90136624				1344-ECP+30	GENERAL MOTORS
VE0140184	12550909				3163-ECP / 1330-ECP	GENERAL MOTORS
VE0140248	93333562	VX 3177 AA			4055-EC	GENERAL MOTORS
VE0140370	7083242				3913-ECB / 3147-ECB	FIAT
VE0141397	93399247	V76379A0			4007-ECB / 4007-EC	GENERAL MOTORS
VE0141573	24578793					GENERAL MOTORS
VE0141574	55563529					GENERAL MOTORS
VE0141576	24579670					GENERAL MOTORS
VE0141580	55569450					GENERAL MOTORS
VE0141582	55570709					GENERAL MOTORS
VE0141706	93382957					GENERAL MOTORS
VE0141709	12625566					GENERAL MOTORS
VE0180125	7701473354 / 8200054762	VX 3102 AA			3599-EB / 3599-E	RENAULT
VE0180305					1363-ECP / 23309-ECBS	RENAULT
VE0180310	8200708662			50.017.936	3527-E / 4185- EN	RENAULT
VE0180396	7700865449				3715-EB / 3717- ECB	RENAULT
VE0180416	7701471280				3865-EB / 3865-E	RENAULT
VE0180422	7701469269				3621-EB	RENAULT
VE0180424	7700855927				3453-EB	RENAULT
VE0181484	7701472670				4081-EPN / 1421-EB	RENAULT
VE0181607 (VE0180438)	13202-00Q0K / 7701473004				3863-EB	NISSAN
VE0181607 (VE0180438)	7701473004 / 13202- 00Q0K				3863-EB	RENAULT
VE0181704	6001552204					RENAULT
VE0181731	132028317R					RENAULT
VE0181747	132021650R					RENAULT
VE0210148	3803524		VS-0985			CUMMINS
VE0210149	3803519		VS-985		1420-EB / 1420- EBS	CUMMINS
VE0210150	3920868 / 3802356		VS-4306		3467-ECB / 3467-ECB C/O	CUMMINS

MAHLE	ORIGINAL	TRW	EATON	KS	3B	LINHA MOTORA
VE0210150	3920868 / 3802356		VS-4306		3467-ECB / 3467-ECB C/O	FORD
VE0210150	3920868 / 3802356		VS-4306		3467-ECB / 3467-ECB C/O	VOLKSWAGEN
VE0210152	3921444 / 3802085		VS-4308		3335-ECP	CUMMINS
VE0210152	3921444 / 3902254		VS-4308		3335-ECP	FORD
VE0210152	3921444 / 3802085		VS-4308		3335-ECP	VOLKSWAGEN
VE0210236	3418021 / 3070159 / 3800639					CUMMINS
VE0210443	3940734				3977-ECB	CUMMINS
VE0211261	3803995 / 3803996 / 3895477					CUMMINS
VE0211372	3942589 / 3800341				4025-ECB	CUMMINS
VE0211428	4089762					CUMMINS
VE0211466	3803529					CUMMINS
VE0211733	BH5T-6505-AA					CUMMINS
VE0230118	800558	VX 0088 AA	VS-770	50.017.760	3273-E / 3272-E	FORD WILLYS
VE0230118	B-27220	VX 0088 AA	VS-770	50.017.760	3273-E / 3272-E	JEEP
VE0250001	59852970	VX 1628 AA	VS-993	50.017.171	1380-EC	FIAT
VE0250019	7633752 / 46470638	VX 2029 AA	VS-4898			FIAT
VE0250051	7574742	VX 2608 AA	VS-4531	50.017.762	3321-ECB	FIAT
VE0250053	5973128	VX 2400 AA	VS-2691	50.017.787	1175-ECSS	FIAT
VE0250059	5973129	VX 2221 AA	VS-2557	50.017.737	1383-EC	FIAT
VE0250158	7597080	VX 2392 AA	VS-2874	50.017.746	1826-ECB	FIAT
VE0250161	7735899	VX 4001 AA			3601-ECBS / 3601-ECB	FIAT
VE0250163	46553049		VS-5088		3559-ECBS / 3559-EC / 3999- ECB	FIAT
VE0250164		VX 4005 AA			3515-EC	FIAT
VE0250167	46553047	VX 3129 AA	VS-5086		3801-EC	FIAT
VE0250169	60811154 / 7766565	VX 4003 AA			3737-ECBS / 3737-ECB	ALFA ROMEO
VE0250169	60811154 / 7766565	VX 4003 AA			3737-ECBS / 3737-ECB	FIAT
VE0250272	55195498	V76563A0			3997-ECB / 3997-EC / 3957- ECB	FIAT
VE0251476	55218807			50.017.972	4257-EC	FIAT
VE0251611	55231699				4155-EN	FIAT
VE0251615	7085037 / 93399248 / 24579671					FIAT
VE0310274	836646357					VALMET / VALTRA
VE0380227	676865-C4					INTERNATIONAL
VE0380229	1810086-C2					INTERNATIONAL
VE0380230	1824838-C1					INTERNATIONAL
VE0381312	1824840-C1					INTERNATIONAL
VE0381700	2U2109611B / 1.839.970- C1					INTERNATIONAL
VE0430542	R-90692				3619-ECB	JOHN DEERE
VE0430542 0,381	R-97492					JOHN DEERE
VE0440297	0949A6 / 962981180				3541-ECB / 3541-EC	PEUGEOT
VE0440301	094962 / 9629861180				3577-ECB	PEUGEOT
VE0440581	9350111780				23241-ECP / 23241-ECP C/O	GENERAL MOTORS
VE0440581	9350111780				23241-ECP / 23241-ECP C/O	PEUGEOT
VE0440581+04					23241-ECP+0,4	GENERAL MOTORS
VE0440581+04					23241-ECP+0,4	PEUGEOT

MAHLE	ORIGINAL	TRW	EATON	KS	3B	LINHA MOTORA
VE0440581+08					23241-ECP+0,8	GENERAL MOTORS
VE0440581+08					23241-ECP+0,8	PEUGEOT
VE0440583	7581717000				1246-EC / 1381-EC C/O	PEUGEOT
VE0440583+04					1246-EC+0,4	PEUGEOT
VE0440583+08					1246-EC+0,8	PEUGEOT
VE0440585	9153501980				23301-ECB / 3303-EC	CITROËN
VE0440585	9153501980				23301-ECB / 3303-EC	PEUGEOT
VE0440588	094959				23242-E / 23242-EP	PEUGEOT
VE0440589	094972 / 9605936280				3543-ECB	PEUGEOT
VE0440590	96172795					CITROËN
VE0440590	96172795					PEUGEOT
VE0440593	97531046				4035-EPN	CITROËN
VE0440593	97531046				4035-EPN	PEUGEOT
VE0440596	96101887				4011-ECB	CITROËN
VE0440596	96101887				4011-ECB	PEUGEOT
VE0440598	0949A8				3617-ECBS / 3617-EBS	CITROËN
VE0440598	0949A8				3617-ECBS / 3617-EBS	PEUGEOT
VE0441382	9153501880					PEUGEOT
VE0441603 (VE0440599)	0949.99 / 0949.E9				3885-ECB	CITROËN
VE0441603 (VE0440599)	0949.99 / 0949.E9				3885-ECB	PEUGEOT
VE0441690	9675424980					CITROËN
VE0441702	9805490180					CITROËN
VE0441702	9805490180					PEUGEOT
VE0461694	07W109611					MAN
VE0461735	2V5109611-A					MAN
VE0480003	3520531505	VX 0282 AB	VS-1178	50.017.049	1226-ECB / 1226-ECB C/O	MERCEDES-BENZ
VE0480005	3660500227	VX 2389 AA	VS-2535	50.017.390	23260-ECB / 23260-ECB C/O / 21226-ECB C/O	MERCEDES-BENZ
VE0480005+04					23260-ECB+0,4	MERCEDES-BENZ
VE0480005+08					23260-ECB+0,8	MERCEDES-BENZ
VE0480047	3460530005	VX 0384 AA	VS-1158	50.017.056	1229-EC / 1229-ECP C/O	MERCEDES-BENZ
VE0480047+04					1229-EC+0.4	MERCEDES-BENZ
VE0480047+08					1229-EC+0.8	MERCEDES-BENZ
VE0480055	4220500127 / 4420500227	VX 2600 AA	VS-4362		1839-ECB / 1839-ECD / 1839-ECB C/O	MERCEDES-BENZ
VE0480079	3450500127 / 7005	VX 1566 AA	VS-1128	50.017.758	1843-ECP / 3263-ECB / 3263-ECB C/O	MERCEDES-BENZ
VE0480079+04					1843-ECP+0,4	MERCEDES-BENZ
VE0480079+08					1843-ECP+0,8	MERCEDES-BENZ
VE0480090	3550530005	VX 0847 AA	VS-1137	50.017.120	3263-ECB / 1843-ECP / 1843-ECP C/O	MERCEDES-BENZ
VE0480097	3760500027 / 3660500027	VX 2391 AA (VA1751A)	VS-2091	50.017.055	23260-ECB / 21226-ECB / 23260-ECB+0,4	MERCEDES-BENZ
VE0480097+04					23260-ECB+0,4	MERCEDES-BENZ
VE0480097+08					23260-ECB+0,8	MERCEDES-BENZ

MAHLE	ORIGINAL	TRW	EATON	KS	3B	LINHA MOTORA
VE0480194	5410500227	VX 2951 AB	VS-5225		3857-ECB	MERCEDES-BENZ
VE0480245	9060500327				3847-ECB / 4109-ECB	MERCEDES-BENZ
VE0480251	6110530005				3659-EN / 4335- EN	MERCEDES-BENZ
VE0481437	A4570500327				4097-ECB	MERCEDES-BENZ
VE0481487	9060500827				4109-ECB	MERCEDES-BENZ
VE0481564	A6510500127					MERCEDES-BENZ
VE0510030	14721-KYO-8901-R	VX 2325 AA	VS-4994	50.017.783	23417-ECBS / 23417-ECB	HONDA
VE0510046	14721-383-000	VX 0787 AA	VS-4918	50.017.779	23293-EP	HONDA
VE0510069	14721-KW1-9000-R	VX 2018 AA	VS-4996	50.017.786	1002-ECB	HONDA
VE0510117	14721-437-0000	VX 0990 AA	VS-4997	50.017.781	23409-ECSS / 23409-ECB	HONDA
VE0510127	14721-GF6-0101	VX 3042 AA			1011-ESN	HONDA
VE0510129	14721-KPF-9000-RW1	VX 3132 AA			3953-EBN	HONDA
VE0510131	14721-471-000		VS-5001	50.017.780	23407-ECSS / 23407-EBN	HONDA
VE0510133	14721-KGO-000		VS-5003	50.017.782	23411-ECSS / 23411-EBN	HONDA
VE0510135	14721-KFO-000		VS-5005	50.017.784	23419-ECSS	HONDA
VE0510192	14721-413-000		VS-5007	50.017.744	1647-EB	HONDA
VE0510196	14721-KGA-B000-R	VX 3208 AA			3839-EN	HONDA
VE0510198	17421-KRM-8400	VX 3274 AA			3905-ECB	HONDA
VE0510210	14721-PO8000 / 14721- P2A-000			50.017.635	3855-EBN / 3433-EBN	HONDA
VE0510228	14721-KSS-9000	VX 3242 AA			4067-ECB	HONDA
VE0510264	14721-PWA-000			50.017.927	4165-EN	HONDA
VE0510266	14721-PWC-000			50.017.929		HONDA
VE0511426	14721-KVS-900					HONDA
VE0511478	14721-KWG-600					HONDA
VE0511629	14721-MAL-600					HONDA
VE0511631	14712-MFJ-D00					HONDA
VE0511635	14721-KBB-900					HONDA
VE0511697	14721-KRE-G00					HONDA
VE0511711	14721-GFM-901					HONDA
VE0511725	14721KVY900					HONDA
VE0511727	14711KWB600					HONDA
VE0511745	14721K31900					HONDA
VE0520200	5HH-12121-00	VX 3286 AA			3951-ESN	YAMAHA
VE0521671	44C-12121-01					YAMAHA
VE0521674	1S4-12121-00					YAMAHA
VE0521713	1ST-E2121-00					YAMAHA
VE0521715	5D9-E2121-10					YAMAHA
VE0521721	5VVE212100					YAMAHA
VE0521737	5VK1212100					YAMAHA
VE0570023	31431851	VX 0604 AA	VS-1161	50.017.793	1249-ECP / 1499-ECP STD	GENERAL MOTORS
VE0570023	31431851	VX 0604 AA	VS-1161	50.017.793	1249-ECP / 1499-ECP STD	PERKINS (MAXION)
VE0570031	70910002	VX 0257 AA	VS-886	50.017.706	248-E C/P	PERKINS (MAXION)
VE0570034	0910041 / 0910073	VX 0087 AA	VS-457	50.017.727	1251-EPMF / 251-E	FORD
VE0570034	0910041 / 0910073	VX 0087 AA	VS-457	50.017.727	1251-EPMF / 251-E	PERKINS (MAXION)
VE0570036	0910002	VX 0091 AA	VS-618	50.017.705	248-E / 248-E C/O	PERKINS (MAXION)
VE0570037	70910018	VX 1913 AA	VS-2816	50.017.770	3393-ECB / 1249-ECP C/O	GENERAL MOTORS

MAHLE	ORIGINAL	TRW	EATON	KS	3B	LINHA MOTORA
VE0570037	70910018	VX 1913 AA	VS-2816	50.017.770	3393-ECB / 1249-ECP C/O	PERKINS (MAXION)
VE0570112	70910012	VX 0441 AA	VS-1424	50.017.740	1498-ECP / 1498-ECP C/O	FORD
VE0570112	70910012	VX 0441 AA	VS-1424	50.017.740	1498-ECP / 1498-ECP C/O	PERKINS (MAXION)
VE0570122	70910038	VX 2298 AA	VS-2833	50.017.766	3389-ECB	GENERAL MOTORS
VE0570122	70910038	VX 2298 AA	VS-2833	50.017.766	3389-ECB	PERKINS (MAXION)
VE0570230	70910054		VS-4892	50.017.847	23345-ECB / 23345-ECBS	FORD
VE0570230	70910054		VS-4892	50.017.847	23345-ECB / 23345-ECBS	GENERAL MOTORS
VE0570230	6010532827		VS-4892	50.017.847	23345-ECB / 23345-ECBS	MERCEDES-BENZ
VE0570230	70910076		VS-4892	50.017.847	23345-ECB / 23345-ECBS	PERKINS (MAXION)
VE0570232	70910080				3859-EBN / 3859-EC	FORD
VE0570232	70910080				3859-EBN / 3859-EC	PERKINS (MAXION)
VE0570649	3142A051					PERKINS (MAXION)
VE0590042	84AU-6505-A	VX 1319 AA	VS-2465	50.017.748	3037-EP	FORD
VE0590065	026 109 611 A	VX 1813 AA	VS-2574	50.017.827	23238-EB	FORD
VE0590065	026 109 611 A	VX 1813 AA	VS-2574	50.017.827	23238-EB	VOLKSWAGEN
VE0590092	78MU-6505-B	VX 0757 AA	VS-1204	50.017.729	1326-E	FORD
VE0590171	XS6E6505AB / 7S6G.6505.AA	V76176A0			3063-ECB / 3063-EC	FORD
VE0590173	97BM-6505-AA	VX 4010 AA			3053-ECB	FORD
VE0590175	XS6E6505BB / YS4E.6505.BA	V74470A0	VS-5127		3093-ECBS / 3093-EC	FORD
VE0590178	X56G6505B2A			50.017.801	3065-EN / 3091- ECB	FORD
VE0590182	948M-6505-D2A		VS-5295		3067-ECB / 3069-ECB / 3067-EC / 3815- EC	FORD
VE0590222	2L2Z-6505-BA					FORD
VE0590256	1S7Z-6505-AA				3095-EC / 3069- ECB	FORD
VE0590276	F77Z-6505-AA / 90TM- 6505-AB				3043-ECP	FORD
VE0591462	F57Z-6505-A				3071-ECP	FORD
VE0591472	AM5G-6505-AB				4345-EN	FORD
VE0591723	E3BG/6505/BB					FORD
VE0630206	13715-16060				3975-EN	TOYOTA
VE0630208	13715-22030				3975-EN / 4183- EN	TOYOTA
VE0630214	13715-0L020				4017-EN	TOYOTA
VE0630241	13715-17010				3779-EBN / 4039-EPN	TOYOTA
VE0630260	13715-58041				3893-EPN	TOYOTA
VE0631406	137157601471					TOYOTA
VE0631454	13715-0L010 / 13715- 30040				4019-EN	TOYOTA
VE0631551	13715-37040					TOYOTA
VE0631641	13715-47020					TOYOTA
VE0631739	1371537060					TOYOTA
VE0700008	036.109.611.J	VX 2989 AA	VS-5223	50.017.861	3509-EB / 3509-E	VOLKSWAGEN

MAHLE	ORIGINAL	TRW	EATON	KS	3B	LINHA MOTORA
VE0700016	035.109.611.F	VX 1472 AA	VS-1696	50.017.397	1815-EB / 1815-EGX	FORD
VE0700016	035.109.611.F	VX 1472 AA	VS-1696	50.017.397	1815-EB / 1815-EGX	VOLKSWAGEN
VE0700021	43109611	VX 0785 AB	VS-1317	50.017.728	1305-ECP	VOLKSWAGEN
VE0700022	311.109.612	VX 0366 AD	VS-1167	50.017.738	1453-E	VOLKSWAGEN
VE0700027	030.109.611.AC	VX 2931 AA	VS-4856	50.017.853	3513-EB	VOLKSWAGEN
VE0700049	040.109.612.2	VX 0201 AA	VS-850	50.017.788	1452-E	VOLKSWAGEN
VE0700062	056.109.611.A	VX 0429 AA	VS-980	50.017.072	1422-EB	VOLKSWAGEN
VE0700073	036.109.611.T	VX 3091 AA			3871-EB	VOLKSWAGEN
VE0700077	049.109.611.F	VX 1203 AA	VS-1357	50.017.386	1825-E	VOLKSWAGEN
VE0700081	068.109.611.C	VX 1209 AA	VS-1359	50.017.017	1303 ECB / 1303-EC	VOLKSWAGEN
VE0700087	048.109.611.C	VX 2976 AA	VS-4511	50.004.601	3485-EBS / 1815-E / 3485-EB	VOLKSWAGEN
VE0700190	048.109.611.B				3485-EBS	VOLKSWAGEN
VE0700220	048.109.611.C					VOLKSWAGEN
VE0700243	058.109.611.E			50.004.508	3489-ECBS / 3489-EC	AUDI
VE0700243	058.109.611.E			50.004.508	3489-ECBS / 3489-EC	VOLKSWAGEN
VE0700253	032.109.611.L	VX 3092 AA			3887-E	VOLKSWAGEN
VE0700268	032.109.611.Q / 032.109.611.N	V75153A0			3887-EB	VOLKSWAGEN
VE0701141	030.109.611.D				3973-EX	SEAT
VE0701141	030.109.611.D				3973-EX	VOLKSWAGEN
VE0701422	030.109.611.AG	V75155A0			3869-EB	VOLKSWAGEN
VE0701460	06D.109.611L					VOLKSWAGEN
VE0701559	03L.109.611				4105-EB	VOLKSWAGEN
VE0701741/3	04C109611					VOLKSWAGEN
VE0701741/4	04C109611					VOLKSWAGEN
VE0710064	467855 / 8194224	VX 1085 AB	VS-4936	50.017.127	1861-ECP / 1861-ECB C/O	VOLVO
VE0710120	468303	VX 1455 AC	VS-4938	50.017.125	1582-ECP	VOLVO
VE0710201	8148574 / 20441945	VX 4018 AA	VS-4968	50.017.667	3915-ECB	VOLVO
VE0710202	20441945					VOLVO
"VE0711695 (VE0711399)"	20768519 / 20768523 / 21016539				4219-EX	VOLVO
VE0711743	3842972					VOLVO
VE0720155				50.017.858	3297-EBN	ASIA MOTORS
VE0720157					1455-ECP	ASIA MOTORS
VE0760012	1100997 / 1360834 / 232018	VX 2019 AA	VS-5166	50.017.790	1374-ECSS / 23395-ECSS / 23395-ECS	SCANIA
VE0760058	232018 / 9639417980	VX 0616 AA	VS-1367	50.017.123	1374-ECSS	SCANIA
VE0760102	1328537	VX 2751 AA			3663-ECBS / 4243-EX	SCANIA
VE0760216	1360833				3803-ECS	SCANIA
VE0761424	1854801			50.017.086		SCANIA
VE1400820	11341739821/ 823				4027-EPN	BMW
VE1950224	MD-198406				3721-EBN	MITSUBISHI
VE1950235	MD-088812					MITSUBISHI
VE1950237	ME-203102				4311-EN	MITSUBISHI
VE1950238	MD-373237					MITSUBISHI
VE1950246	ME-202688				3581-EBN	MITSUBISHI
VE1950262	MD-197106				3465-EBM / 3465-EBN	MITSUBISHI
VE1950826	MD-085254				4033-EPN	MITSUBISHI
VE1950828	MD-162616					MITSUBISHI

MAHLE	ORIGINAL	TRW	EATON	KS	3B	LINHA MOTORA
VE1951572	MD-162423					MITSUBISHI
VE1961404	87802266					CASE
VE2080848	22212-42520				3897-EN / 3721-EBN / 3595-EP	HYUNDAI
VE2081302	22212-42220				4171-EN	HYUNDAI
VE2081418	22212-23600					HYUNDAI
VE2081418	22212-23600					KIA MOTORS
VE2081553	22212-2B000					HYUNDAI
VE2081553	22212-2B000					KIA MOTORS
VE2081665	22212-04070					HYUNDAI
VE2081665	22212-04070					KIA MOTORS
VE2110186	ON01-12-121		VS-5282	50.017.851	3548-EBN / 3549-EBN	KIA MOTORS
VE2110186	ON01-12-121		VS-5282	50.017.851	3548-EBN / 3549-EBN	MAZDA
VE2110188	OK63C-12-121		VS-5297		3827-EBN	KIA MOTORS
VE2081729	222122E400					HYUNDAI
VE2110249	K710-12-121				3299-EN	KIA MOTORS
VE2110249	K710-12-121				3299-EN	MAZDA
VE2111420	OFE 3P 12121					HYSTER
VE2111420	OFE 3P 12121					KIA MOTORS
VE2111420	OFE 3P 12121					YALE
VE2111595	22212-4A061					HYUNDAI
VE3481578	372-1007012					CHERY
VE3551557	1003013GG013					JAC MOTORS
VE5081717	12912-12F60					SUZUKI
VE5081719	12912-20E00-000					SUZUKI
VE5511555	14721-RC0-M00				4167-EN	HONDA
VE5511569	14721-P1J-L00					HONDA
VE5511749	14721R2CT00 / 14721R2HT00 / 14721P2A000					HONDA

ORIGINAL	MAHLE	TRW	EATON	KS	3B	LINHA MOTORA
026.109.601.D	VA0590067	VX 1947 AA	VS-2639		3602-A	FORD
026.109.601.D	VA0590067	VX 1947 AA	VS-2639		3602-A	VOLKSWAGEN
026.109.611.A	VE0590065	VX 1813 AA	VS-2574	50.017.827	23238-EB	FORD
026.109.611.A	VE0590065	VX 1813 AA	VS-2574	50.017.827	23238-EB	VOLKSWAGEN
029.109.601.1	VA0590044	VX 1321 AA	VS-1492	50.017.797	814-AC / 816-AC	FORD
029.109.601.1	VA0590044	VX 1321 AA	VS-1492	50.017.797	814-AC / 816-AC	VOLKSWAGEN
030.109.601.AC	VA0700028	VX 2930 AA	VS-4919	50.017.849	3512-A	VOLKSWAGEN
030.109.601.AS	VA0701421	V75154A0			3868-A	VOLKSWAGEN
030.109.601.G	VA0700758				3972-A	SEAT
030.109.601.G	VA0700758				3972-A	VOLKSWAGEN
030.109.611.AC	VE0700027	VX 2931 AA	VS-4856	50.017.853	3513-EB	VOLKSWAGEN
030.109.611.AG	VE0701422	V75155A0			3869-EB	VOLKSWAGEN
030.109.611.D	VE0701141				3973-EX	SEAT
030.109.611.D	VE0701141				3973-EX	VOLKSWAGEN
032.109.601.M	VA0700252	VX 3066 AA	VS-4893	50.017.846	3886-A	VOLKSWAGEN
032.109.601.P	VA0700267	V75152A0				VOLKSWAGEN
032.109.611.L	VE0700253	VX 3092 AA			3887-E	VOLKSWAGEN
032.109.611.Q / 032.109.611.N	VE0700268	V75153A0			3887-EB	VOLKSWAGEN
035.109.601.C	VA0700017	VX 1368 AA	VS-1646	50.017.396	815-AC	VOLKSWAGEN
035.109.601.G	VA0590066	VX 1812 AB	VS-4762	50.017.826	3312-A	FORD
035.109.601.G	VA0590066	VX 1812 AB	VS-4762	50.017.826	3312-A	VOLKSWAGEN
035.109.611.F	VE0700016	VX 1472 AA	VS-1696	50.017.397	1815-EB / 1815-EGX	FORD
035.109.611.F	VE0700016	VX 1472 AA	VS-1696	50.017.397	1815-EB / 1815-EGX	VOLKSWAGEN
036.109.601.AE	VA0700074	VX 3090 AA			3870-A	VOLKSWAGEN
036.109.601.R	VA0700009	VX 2875 AA	VS-5127	50.017.860	3508-A	VOLKSWAGEN
036.109.611.J	VE0700008	VX 2989 AA	VS-5223	50.017.861	3509-EB / 3509-E	VOLKSWAGEN
036.109.611.T	VE0700073	VX 3091 AA			3871-EB	VOLKSWAGEN
03L.109.601	VA0701558				4104-A	VOLKSWAGEN
03L.109.611	VE0701559				4105-EB	VOLKSWAGEN
040.109.601.1	VA0700050	VX 0435 AF	VS-868	50.017.715	422-A / 452-A	VOLKSWAGEN
040.109.601.2	VA0700020	VX 0434 AG	VS-869	50.017.716	452-A / 453-A	VOLKSWAGEN
040.109.612.2	VE0700049	VX 0201 AA	VS-850	50.017.788	1452-E	VOLKSWAGEN
048.109.601.E	VA0700088	VX 2923 AA	VS-4510	50.004.599	3484-AB / 815-A / 3484-A / 3486-A / 3238-A / 3310-A	VOLKSWAGEN
048.109.611.B	VE0700190				3485-EBS	VOLKSWAGEN
048.109.611.C	VE0700087	VX 2976 AA	VS-4511	50.004.601	3485-EBS / 1815-E / 3485-EB	VOLKSWAGEN
048.109.611.C	VE0700220					VOLKSWAGEN
049.109.601.F	VA0700078	VX 1202 AA	VS-1356	50.017.385	825-A	VOLKSWAGEN
049.109.611.F	VE0700077	VX 1203 AA	VS-1357	50.017.386	1825-E	VOLKSWAGEN
04C109601B	VA0701740/3					VOLKSWAGEN
04C109601B	VA0701740/4					VOLKSWAGEN
04C109611	VE0701741/3					VOLKSWAGEN
04C109611	VE0701741/4					VOLKSWAGEN
056.109.601.A	VA0700061	VX 0428 AF	VS-981	50.017.392	422-AC / 422-A	VOLKSWAGEN
056.109.611.A	VE0700062	VX 0429 AA	VS-980	50.017.072	1422-EB	VOLKSWAGEN
058.109.601.C	VA0700242			50.004.507	3488-AS	AUDI
058.109.601.C	VA0700242			50.004.507	3488-AS	VOLKSWAGEN
058.109.611.E	VE0700243			50.004.508	3489-ECBS / 3489-EC	AUDI
058.109.611.E	VE0700243			50.004.508	3489-ECBS / 3489- EC	VOLKSWAGEN
068.109.601.C	VA0700082	VX 1210 AA	VS-1358	50.017.016	303-AC	VOLKSWAGEN
068.109.611.C	VE0700081	VX 1209 AA	VS-1359	50.017.017	1303 ECB / 1303-EC	VOLKSWAGEN
06D.109.601K	VA0701459					VOLKSWAGEN
06D.109.611L	VE0701460					VOLKSWAGEN
078.109.601.B	VA0700089	VX 2975 AA	VS-4546	50.004.600	1718-A / 3486-A / 3313-A	VOLKSWAGEN
07W109601	VA0461693					MAN

ORIGINAL	MAHLE	TRW	EATON	KS	3B	LINHA MOTORA
07W109611	VE0461694					MAN
094861	VA0440569				3576-A	PEUGEOT
094866	VA0440557				3542-A	PEUGEOT
094891	VA0441091				3798-A / 3242-A	PEUGEOT
094892	VA0440561				3540-A	PEUGEOT
094959	VE0440588				23242-E / 23242-EP	PEUGEOT
094962	VE0440301				3577-ECB	PEUGEOT
094972	VE0440589				3543-ECB	PEUGEOT
0910001	VA0570035	VX 0092 AB	VS-620		247-A / 247-A C/O	PERKINS (MAXION)
0910002	VE0570036	VX 0091 AA	VS-618	50.017.705	248-E / 248-E C/O	PERKINS (MAXION)
0910030	VA0570033	VX 0090 AA	VS-1754	50.017.707	250-AMF / 250-A	FORD
0910030	VA0570033	VX 0090 AA	VS-1754	50.017.707	250-AMF / 250-A	PERKINS (MAXION)
0910041	VE0570034	VX 0087 AA	VS-457	50.017.727	1251-EPMF / 251-E	FORD
0910041	VE0570034	VX 0087 AA	VS-457	50.017.727	1251-EPMF / 251-E	PERKINS (MAXION)
0910069	VA0570033	VX 0090 AA	VS-1754	50.017.707	250-AMF / 250-A	FORD
0910069	VA0570033	VX 0090 AA	VS-1754	50.017.707	250-AMF / 250-A	PERKINS (MAXION)
0910073	VE0570034	VX 0087 AA	VS-457	50.017.727	1251-EPMF / 251-E	FORD
0910073	VE0570034	VX 0087 AA	VS-457	50.017.727	1251-EPMF / 251-E	PERKINS (MAXION)
0948.99	VA0440579				3884-A	CITROËN
0948.99	VA0440579				3884-A	PEUGEOT
0948.F4	VA0440579				3884-A	CITROËN
0948.F4	VA0440579				3884-A	PEUGEOT
0948A9	VA0440578				3616-A	CITROËN
0948A9	VA0440578				3616-A	PEUGEOT
0949.99	VE0441603 (VE0440599)				3885-ECB	CITROËN
0949.99	VE0441603 (VE0440599)				3885-ECB	PEUGEOT
0949.E9	VE0441603 (VE0440599)				3885-ECB	CITROËN
0949.E9	VE0441603 (VE0440599)				3885-ECB	PEUGEOT
0949A6	VE0440297				3541-ECB / 3541-EC	PEUGEOT
0949A8	VE0440598				3617-ECBS / 3617- EBS	CITROËN
0949A8	VE0440598				3617-ECBS / 3617- EBS	PEUGEOT
1.839.968-C1	VA0381699					INTERNATIONAL
1.839.970-C1	VE0381700					INTERNATIONAL
10241743	VA0140183				3164-AC / 487-AC	GENERAL MOTORS
1003012GG013	VA3551556					JAC MOTORS
1003013GG013	VE3551557					JAC MOTORS
1100997	VE0760012	VX 2019 AA	VS-5166	50.017.790	1374-ECSS / 23395- ECSS / 23395-ECS	SCANIA
11341739820/ 822	VA1401226				4026-AN	BMW
11341739821/ 823	VE1400820				4027-EPN	BMW
12911-12F60	VA5081716					SUZUKI
12911-20E00-000	VA5081718					SUZUKI
12912-12F60	VE5081717					SUZUKI
12912-20E00-000	VE5081719					SUZUKI
12550909	VE0140184				3163-ECP / 1330-ECP	GENERAL MOTORS
12615936	VA0141575					GENERAL MOTORS
12625566	VE0141709					GENERAL MOTORS
135957	VA0210147				420-A	CUMMINS
1319081	VA0760215				3802-ACB	SCANIA
1328537	VE0760102	VX 2751 AA			3663-ECBS / 4243-EX	SCANIA
1333230	VA0760103	VX 2750 AA		50.009.016	3662-ACB / 3663- ECBS / 4242-AX	SCANIA

ORIGINAL	MAHLE	TRW	EATON	KS	3B	LINHA MOTORA
1360833	VE0760216				3803-ECS	SCANIA
1360834	VE0760012	VX 2019 AA	VS-5166	50.017.790	1374-ECSS / 23395-ECSS / 23395-ECS	SCANIA
137117601271	VA0631405					TOYOTA
137157601471	VE0631406					TOYOTA
13201-00Q0H	VA0181606 (VA0180427)				3862-A	NISSAN
132010427R	VA0181730					RENAULT
13201-3AC0A	VA0031608					NISSAN
13201-4589R	VA0031604					RENAULT
13201-50K00	VA0030331				4028-AN / 4028-AN	NISSAN
13201-AD210 (13201-5X00B)	VA0031617 (VA0031506)				4136-A	NISSAN
13201-CP50A	VA0031570				4134-A	NISSAN
13202-00Q0K	VE0181607 (VE0180438)				3863-EB	NISSAN
13202-0970R	VE0031605				4135-EN	RENAULT
132021650R	VE0181747					RENAULT
13202-3HC0A	VE0031609					NISSAN
13202-50K02	VE0031124				4029-EPN	NISSAN
132028317R	VE0181731					RENAULT
13202-AD200 (13202-5X00B)	VE0031618 (VE0031507)				4137-EN	NISSAN
13202-EN20B	VE0031605				4135-EN	NISSAN
136-0819	VE0110233		VS-3140		3615-EC	CATERPILLAR
136-0819	VE0110233		VS-3140		3615-EC	GENERAL MOTORS
13711-0L010	VA0631453				4018-AN	TOYOTA
13711-0L020	VA0630213				4016-AN	TOYOTA
13711-15090	VA0630205				3974-AN	TOYOTA
13711-17010	VA0630240				3778-AN / 4038-AN	TOYOTA
13711-22030	VA0630207					TOYOTA
13711-30040	VA0631453				4018-AN	TOYOTA
13711-37030	VA0631550					TOYOTA
13711-47020	VA0631640					TOYOTA
13711-58021	VA0630259				3892-AN	TOYOTA
13715-0L010	VE0631454				4019-EN	TOYOTA
13715-0L020	VE0630214				4017-EN	TOYOTA
13715-16060	VE0630206				3975-EN	TOYOTA
13715-17010	VE0630241				3779-EBN / 4039-EPN	TOYOTA
13715-22030	VE0630208				3975-EN / 4183-EN	TOYOTA
13715-30040	VE0631454				4019-EN	TOYOTA
13715-37040	VE0631551					TOYOTA
13715-47020	VE0631641					TOYOTA
13715-58041	VE0630260				3893-EPN	TOYOTA
1456855	VA0111407					CATERPILLAR
1456857	VE0111408					CATERPILLAR
1487455	VE0110146		VS-2402		23210-EBS	CATERPILLAR
14711-383-000	VA0510045	VX 0786 AA	VS-4906	50.017.778	23293-AP	HONDA
14711-397-6300	VA0510116	VX 1473 AA	VS-4917	50.017.772	3408-AC	HONDA
14711-413-000	VA0510191		VS-5006	50.017.743	1647-AB	HONDA
14711-428-000	VA0510130		VS-5000	50.017.771	3406-AN	HONDA
14711-440-0030-BR	VA0510115	VX 0989 AA	VS-4985		3408-AC	HONDA
14711-GFM-900	VA0511710					HONDA
14711-GN5-9130	VA0510126	VX 3043 AA		50.017.464	1010-A	HONDA
14711K31900	VA0511744					HONDA
14711K70600	VA0511726					HONDA
14711-KBB-900	VA0511634					HONDA

ORIGINAL	MAHLE	TRW	EATON	KS	3B	LINHA MOTORA
14711-KCY-670	VA0510269					HONDA
14711-KGA-B000-R	VA0510195	VX 3207 AA			3838-AN	HONDA
14711-KGO-000	VA0510132		VS-5002	50.017.773	3410-ANS / 3410-AN	HONDA
14711-KL3-670	VA0510134		VS-5004	50.017.843	3418-ACS	HONDA
14711-KPF-9000-RW1	VA0510128	VX 3131 AA			3952-AN	HONDA
14711-KRE-G00	VA0511696					HONDA
14711-KRM-8400	VA0510197	VX 3273 AA			3904-AC	HONDA
14711-KSS-9000	VA0510227	VX 3204 AA			4066-A	HONDA
14711-KVS-900	VA0511425					HONDA
14711-KW1-9000-R	VA0510070	VX 2009 AA	VS-4995	50.017.785	1001-AC	HONDA
14711KWB600	VA0511724					HONDA
14711KWB600	VE0511727					HONDA
14711-KWG-600	VA0511477					HONDA
14711-KYO-8901-R	VA0510029	VX 2324 AA	VS-4993	50.017.774	3416-AC	HONDA
14711-MAL-600	VA0511628					HONDA
14711-MFJ-D00	VA0511630					HONDA
14711-PO8000	VA0510209				3854-AN / 3432-A	HONDA
14711-PWA-000	VA0510263			50.017.926	4164-AN	HONDA
14711-PWC-000	VA0510265			50.017.928		HONDA
14711R1ZA00	VA5511748					HONDA
14711-RC0-M00	VA5511554				4166-AN	HONDA
14711-RNA-A00	VA0510257			50.017.930		HONDA
14711-RNE-A00	VA5511568					HONDA
14712-MFJ-D00	VE0511631					HONDA
14721-383-000	VE0510046	VX 0787 AA	VS-4918	50.017.779	23293-EP	HONDA
14721-413-000	VE0510192		VS-5007	50.017.744	1647-EB	HONDA
14721-437-0000	VE0510117	VX 0990 AA	VS-4997	50.017.781	23409-ECSS / 23409-ECB	HONDA
14721-471-000	VE0510131		VS-5001	50.017.780	23407-ECSS / 23407-EBN	HONDA
14721-GF6-0101	VE0510127	VX 3042 AA			1011-ESN	HONDA
14721-GFM-901	VE0511711					HONDA
14721K31900	VE0511745					HONDA
14721-KBB-900	VE0511635					HONDA
14721-KFO-000	VE0510135		VS-5005	50.017.784	23419-ECSS	HONDA
14721-KGA-B000-R	VE0510196	VX 3208 AA			3839-EN	HONDA
14721-KGO-000	VE0510133		VS-5003	50.017.782	23411-ECSS / 23411-EBN	HONDA
14721-KPF-9000-RW1	VE0510129	VX 3132 AA			3953-EBN	HONDA
14721-KRE-G00	VE0511697					HONDA
14721-KSS-9000	VE0510228	VX 3242 AA			4067-ECB	HONDA
14721-KVS-900	VE0511426					HONDA
14721KVY900	VE0511725					HONDA
14721-KW1-9000-R	VE0510069	VX 2018 AA	VS-4996	50.017.786	1002-ECB	HONDA
14721-KWG-600	VE0511478					HONDA
14721-KYO-8901-R	VE0510030	VX 2325 AA	VS-4994	50.017.783	23417-ECBS / 23417-ECB	HONDA
14721-MAL-600	VE0511629					HONDA
14721-P1J-L00	VE5511569					HONDA
14721P2A000	VE5511749					HONDA
14721-P2A-000	VE0510210			50.017.635	3855-EBN / 3433-EBN	HONDA
14721-PO8000	VE0510210			50.017.635	3855-EBN / 3433-EBN	HONDA
14721-PWA-000	VE0510264			50.017.927	4165-EN	HONDA
14721-PWC-000	VE0510266			50.017.929		HONDA
14721R2CT00	VE5511749					HONDA
14721R2HT00	VE5511749					HONDA

ORIGINAL	MAHLE	TRW	EATON	KS	3B	LINHA MOTORA
14721-RC0-M00	VE5511555				4167-EN	HONDA
1515743	VA0760103	VX 2750 AA		50.009.016	3662-ACB / 3663-ECBS / 4242-AX	SCANIA
1547492	VA0710203	VX 4017 AA	VS-5143	50.017.689	3914-ACB / 4092-ACB	VOLVO
1632442	VA0111411					CATERPILLAR
1785076	VA0760225					SCANIA
17421-KRM-8400	VE0510198	VX 3274 AA			3905-ECB	HONDA
1854801	VE0761424			50.017.086		SCANIA
1883122	VE0111412					CATERPILLAR
1887056	VA0761423			50.017.087		SCANIA
1810086-C2	VE0380229					INTERNATIONAL
1818580-C1	VA0380231					INTERNATIONAL
1823875-C1	VA0381304				3968-AC	INTERNATIONAL
1824838-C1	VE0380230					INTERNATIONAL
1824840-C1	VE0381312					INTERNATIONAL
1S4-12121-00	VE0521674					YAMAHA
1S4E-E2111-00	VA0521673					YAMAHA
1S4G-6507-CB	VA0591471				4344-AN	FORD
1S7Z-6505-AA	VE0590256				3095-EC / 3069-ECB	FORD
1S7Z-6507-AA	VA0590255				3094-AC / 3068-AC	FORD
1ST-E2111-00	VA0521712					YAMAHA
1ST-E2121-00	VE0521713					YAMAHA
20441945	VE0710201	VX 4018 AA	VS-4968	50.017.667	3915-ECB	VOLVO
20737856	VA0711742					VOLVO
20441945	VE0710202					VOLVO
20740798	"VE0711695 (VE0711399)"				4218-AX	VOLVO
20768519	"VE0711695 (VE0711399)"				4219-EX	VOLVO
20768523	"VE0711695 (VE0711399)"				4219-EX	VOLVO
21299685	VE0131751					MWM
21299686	VA0131750					MWM
2102529	VE0111414					CATERPILLAR
2102542	VA0111413					CATERPILLAR
21016539	VE0711399				4219-EX	VOLVO
22211-04000	VA2081664					HYUNDAI
22211-04000	VA2081664					KIA MOTORS
22211-23600	VA2081417					HYUNDAI
22211-23600	VA2081417					KIA MOTORS
22211-2B400	VA2081552					HYUNDAI
22211-2B400	VA2081552					KIA MOTORS
22211-42220	VA2081301				4170-AN	HYUNDAI
22211-42520	VA2080849				3896-AN / 3594-AN	HYUNDAI
22211-4A061	VA2111594					HYUNDAI
22212-04070	VE2081665					HYUNDAI
22212-04070	VE2081665					KIA MOTORS
22212-23600	VE2081418					HYUNDAI
22212-23600	VE2081418					KIA MOTORS
22212-2B000	VE2081553					HYUNDAI
222122E400	VE2081729					HYUNDAI
22212-2B000	VE2081553					KIA MOTORS
22212-42220	VE2081302				4171-EN	HYUNDAI
22212-42520	VE2080848				3897-EN / 3721-EBN / 3595-EP	HYUNDAI
22212-4A061	VE2111595					HYUNDAI
232018	VE0760012	VX 2019 AA	VS-5166	50.017.790	1374-ECSS / 23395-ECSS / 23395-ECS	SCANIA

ORIGINAL	MAHLE	TRW	EATON	KS	3B	LINHA MOTORA
232018	VE0760058	VX 0616 AA	VS-1367	50.017.123	1374-ECSS	SCANIA
2335469	VA0111415					CATERPILLAR
2335470	VE0111416					CATERPILLAR
237959	VA0761145					SCANIA
24578793	VE0141573					GENERAL MOTORS
24579670	VE0141576					GENERAL MOTORS
24579671	VE0251615					FIAT
2638552	VA0140104	VX 0220 AB	VS-1202	50.017.701	137-A / 137-AG	GENERAL MOTORS
272803	VA0761145					SCANIA
2787538	VA0140108	VX 0221 AA +3	VS-865	50.017.702	137-A+3 / 137-AG+3	GENERAL MOTORS
289483	VA0760013	VX 1784 AA	VS-4905	50.017.789	1374-ACB 20° / 23394-ACBS / 23394- ACB	SCANIA
294674	VA0760013	VX 1784 AA	VS-4905	50.017.789	1374-ACB 20° / 23394-ACBS / 23394- ACB	SCANIA
2L2Z-6505-BA	VE0590222					FORD
2L2Z-6507-BA	VA0590221					FORD
2U2109601A	VA0381699					INTERNATIONAL
2U2109611B	VE0381700					INTERNATIONAL
2V5109601	VA0461734					MAN
2V5109611-A	VE0461735					MAN
3033234	VA0210446					CUMMINS
3068828	VA0210237					CUMMINS
3070159	VE0210236					CUMMINS
31431261	VA0570035	VX 0092 AB	VS-620		247-A / 247-A C/O	PERKINS (MAXION)
31431315	VA0570024	VX 0602 AA	VS-1160	50.017.792	249-AC	GENERAL MOTORS
31431315	VA0570024	VX 0602 AA	VS-1160	50.017.792	249-AC	PERKINS (MAXION)
31431723	VA0570111	VX 0440 AA	VS-1423	50.017.739	1498-ACP / 1498- ACP C/O	FORD
31431723	VA0570111	VX 0440 AA	VS-1423	50.017.739	1498-ACP / 1498- ACP C/O	PERKINS (MAXION)
31431851	VE0570023	VX 0604 AA	VS-1161	50.017.793	1249-ECP / 1499- ECP STD	GENERAL MOTORS
31431851	VE0570023	VX 0604 AA	VS-1161	50.017.793	1249-ECP / 1499- ECP STD	PERKINS (MAXION)
311.109.612	VE0700022	VX 0366 AD	VS-1167	50.017.738	1453-E	VOLKSWAGEN
3142A051	VE0570649					PERKINS (MAXION)
3418020	VA0210237					CUMMINS
3418021	VE0210236					CUMMINS
3450537001	VA0480080	VX 1565 AA	VS-1129	50.017.757	843-AC / 3262-AC / 3262-AC C/O	MERCEDES-BENZ
3460530001	VA0480048	VX 0383 AA	VS-1157	50.017.044	229-AC / 229-AC C/O	MERCEDES-BENZ
3460530005	VE0480047	VX 0384 AA	VS-1158	50.017.056	1229-EC / 1229-ECP C/O	MERCEDES-BENZ
3450500127 / 7005	VE0480079	VX 1566 AA	VS-1128	50.017.758	1843-ECP / 3263- ECB / 3263-ECB C/O	MERCEDES-BENZ
352211	VA0760013	VX 1784 AA	VS-4905	50.017.789	1374-ACB 20° / 23394-ACBS / 23394- ACB	SCANIA
352212	VA0760013	VX 1784 AA	VS-4905	50.017.789	1374-ACB 20° / 23394-ACBS / 23394- ACB	SCANIA
3520530101	VA0480004	VX 0246 AE	VS-1177	50.017.042	226-AC / 226-AC C/O	MERCEDES-BENZ
3520531505	VE0480003	VX 0282 AB	VS-1178	50.017.049	1226-ECB / 1226- ECB C/O	MERCEDES-BENZ
3550530001	VA0480091	VX 0846 AA	VS-1136	50.017.119	3262-AC / 843-AC / 843-AC C/O	MERCEDES-BENZ
3550530005	VE0480090	VX 0847 AA	VS-1137	50.017.120	3263-ECB / 1843- ECP / 1843-ECP C/O	MERCEDES-BENZ

ORIGINAL	MAHLE	TRW	EATON	KS	3B	LINHA MOTORA
3695455	VA0140106	VX 0013 AA	VS-0040	50.017.700	135-A	GENERAL MOTORS
3660500027	VE0480097	VX 2391 AA (VA1751A)	VS-2091	50.017.055	23260-ECB / 21226-ECB / 23260- ECB+0,4	MERCEDES-BENZ
3660500227	VE0480005	VX 2389 AA	VS-2535	50.017.390	23260-ECB / 23260- ECB C/O / 21226- ECB C/O	MERCEDES-BENZ
3660501226	VA0480007	VX 2811 AA	VS-2770	50.017.794	3260-ACB-20° / 3260-ACB C/O	MERCEDES-BENZ
3724778	VE0140105	VX 0219 AB - STD	VS-1201	50.017.721	1138-EG / 1138-E / 1138-E STD	GENERAL MOTORS
3732758	VE0140107	VX 0238 AA +3	VS-1335	50.017.722	1138-EG+3	GENERAL MOTORS
3758810	VA0140106	VX 0013 AA	VS-0040	50.017.700	135-A	GENERAL MOTORS
3774052	VA0140104	VX 0220 AB	VS-1202	50.017.701	137-A / 137-AG	GENERAL MOTORS
3786360	VA0140108	VX 0221 AA +3	VS-865	50.017.702	137-A+3 / 137-AG+3	GENERAL MOTORS
3786361	VA0140110	VX 0222 AA +15	VS-866	50.017.703	137-A+15 / 137- AG+15	GENERAL MOTORS
3760500027	VE0480097	VX 2391 AA (VA1751A)	VS-2091	50.017.055	23260-ECB / 21226-ECB / 23260- ECB+0,4	MERCEDES-BENZ
3760530001	VA0480096	VX 2390 AA (VA1648A)	VS-2587	50.017.389	2026-AC 30°	MERCEDES-BENZ
3760530101	VA0480006	VX 2388 AA	VS-1814	50.017.391	3260-ACB / 3260- ACB 20 C/O / 2026- AC 30 C/O	MERCEDES-BENZ
372-1007011	VA3481577					CHERY
372-1007012	VE3481578					CHERY
3800340	VA0211371				4024-AC	CUMMINS
3800341	VE0211372				4025-ECB	CUMMINS
3800638	VA0210237					CUMMINS
3800639	VE0210236					CUMMINS
3801356	VA0210446					CUMMINS
3802085	VE0210152		VS-4308		3335-ECP	CUMMINS
3802085	VE0210152		VS-4308		3335-ECP	VOLKSWAGEN
3802355	VA0210151		VS-4307		3466-AC / 3466-AC C/O	CUMMINS
3802356	VE0210150		VS-4306		3467-ECB / 3467- ECB C/O	CUMMINS
3802356	VA0210151		VS-4307		3466-AC / 3466-AC C/O	FORD
3802356	VE0210150		VS-4306		3467-ECB / 3467- ECB C/O	FORD
3802356	VA0210151		VS-4307		3466-AC / 3466-AC C/O	VOLKSWAGEN
3802356	VE0210150		VS-4306		3467-ECB / 3467- ECB C/O	VOLKSWAGEN
3802463	VA0210153		VS-4309		3334-AC	CUMMINS
3802463	VA0210153		VS-4309		3334-AC	VOLKSWAGEN
3803515	VA0211465					CUMMINS
3803519	VE0210149		VS-985		1420-EB / 1420-EBS	CUMMINS
3803524	VE0210148		VS-0985			CUMMINS
3803529	VE0211466					CUMMINS
3803995	VE0211261					CUMMINS
3803996	VE0211261					CUMMINS
3842972	VE0711743					VOLVO
3895477	VE0211261					CUMMINS
3902253	VA0210153		VS-4309		3334-AC	FORD
3902254	VE0210152		VS-4308		3335-ECP	FORD

ORIGINAL	MAHLE	TRW	EATON	KS	3B	LINHA MOTORA
3920867	VA0210151		VS-4307		3466-AC / 3466-AC C/O	CUMMINS
3920867	VA0210151		VS-4307		3466-AC / 3466-AC C/O	FORD
3920867	VA0210151		VS-4307		3466-AC / 3466-AC C/O	VOLKSWAGEN
3920868	VE0210150		VS-4306		3467-ECB / 3467-ECB C/O	CUMMINS
3920868	VE0210150		VS-4306		3467-ECB / 3467-ECB C/O	FORD
3920868	VE0210150		VS-4306		3467-ECB / 3467-ECB C/O	VOLKSWAGEN
3921444	VE0210152		VS-4308		3335-ECP	CUMMINS
3921444	VE0210152		VS-4308		3335-ECP	FORD
3921444	VE0210152		VS-4308		3335-ECP	VOLKSWAGEN
3924492	VA0210153		VS-4309		3334-AC	CUMMINS
3924492	VA0210153		VS-4309		3334-AC	FORD
3924492	VA0210153		VS-4309		3334-AC	VOLKSWAGEN
3940734	VE0210443				3977-ECB	CUMMINS
3940735	VA0210442		VS-5102		3976-AC	CUMMINS
3942588	VA0211371				4024-AC	CUMMINS
3942589	VE0211372				4025-ECB	CUMMINS
3989084	VE0140105	VX 0219 AB - STD	VS-1201	50.017.721	1138-EG / 1138-E / 1138-E STD	GENERAL MOTORS
3995603	VE0140109	VX 0239 AA +15	VS-1481	50.017.723	1138-EG+15	GENERAL MOTORS
3995685	VA0140110	VX 0222 AA +15	VS-866	50.017.703	137-A+15 / 137-AG+15	GENERAL MOTORS
4089761	VA0211427					CUMMINS
4089762	VE0211428					CUMMINS
4239917	VA0250060	VX 2220 AA	VS-2556	50.017.714	175-AC / 383-AC	FIAT
4220500127	VE0480055	VX 2600 AA	VS-4362		1839-ECB / 1839-ECD / 1839-ECB C/O	MERCEDES-BENZ
4220500226	VA0480056	VX 2387 AA	VS-2520	50.017.046	1839-ACB / 1839-ACB C/O	MERCEDES-BENZ
43109611	VE0700021	VX 0785 AB	VS-1317	50.017.728	1305-ECP	VOLKSWAGEN
43401180	VA0250002	VX 0514 AB	VS-992	50.017.170	380-AC	FIAT
4460697	VA0250060	VX 2220 AA	VS-2556	50.017.714	175-AC / 383-AC	FIAT
4420500227	VE0480055	VX 2600 AA	VS-4362		1839-ECB / 1839-ECD / 1839-ECB C/O	MERCEDES-BENZ
4420500526	VA0480056	VX 2387 AA	VS-2520	50.017.046	1839-ACB / 1839-ACB C/O	MERCEDES-BENZ
44C-12111-01	VA0521670					YAMAHA
44C-12121-01	VE0521671					YAMAHA
5D9-E2111-10	VA0521714					YAMAHA
5D9-E2121-10	VE0521715					YAMAHA
467855	VE0710064	VX 1085 AB	VS-4936	50.017.127	1861-ECP / 1861-ECB C/O	VOLVO
468302	VA0710121	VX 1594 AA	VS-4937	50.017.124	582-AC	VOLVO
468303	VE0710120	VX 1455 AC	VS-4938	50.017.125	1582-ECP	VOLVO
469240	VA0710063	VX 0588 AB	VS-4934	50.017.126	860-AC / 860-AC C/O	VOLVO
4675002	VA0710063	VX 0588 AB	VS-4934	50.017.126	860-AC / 860-AC C/O	VOLVO
46470637	VA0250018	VX 2028 AA	VS-4897	50.017.756	3234-AC	FIAT
46470638	VE0250019	VX 2029 AA	VS-4898			FIAT
46553046	VA0250162	VX 3128 AA	VS-5087		3800-AC	FIAT
46553047	VE0250167	VX 3129 AA	VS-5086		3801-EC	FIAT
46553048	VA0250166		VS-5085		3558-AC / 3998-AC	FIAT
46553049	VE0250163		VS-5088		3559-ECBS / 3559-EC / 3999-ECB	FIAT
46559031	VA0250018	VX 2028 AA	VS-4897	50.017.756	3234-AC	FIAT

ORIGINAL	MAHLE	TRW	EATON	KS	3B	LINHA MOTORA
500355778	VA0011469			50.017.897	4094-AC	IVECO
504069199	VA0011475				4112-AC	IVECO
504072531	VA0011467				4246-AC	IVECO
504081062	VE0011468				4247-EC	IVECO
504293892	VE0011470			50.017.898	4095-ECB	IVECO
504378070	VE0011616				4113-EC	IVECO
52285384	VA0140041	VX 2034 AA	VS-1660	50.017.753	3045-ECP / 3110-AC	GENERAL MOTORS
5410500226	VA0480193		VS-5037		3856-AC / 4096-AC	MERCEDES-BENZ
5410500227	VE0480194	VX 2951 AB	VS-5225		3857-ECB	MERCEDES-BENZ
6001552204	VE0181704					RENAULT
6001552205	VA0181703					RENAULT
55195497	VA0250271	V76562A0			3956-AC	FIAT
55195498	VE0250272	V76563A0			3997-ECB / 3997-EC / 3957-ECB	FIAT
55218807	VE0251476			50.017.972	4257-EC	FIAT
55219002	VA0251633				4156-AC / 4256-AC	FIAT
55224590	VA0251610				4154-AC	FIAT
55231699	VE0251611				4155-EN	FIAT
55240709	VA0251632					FIAT
55563529	VE0141574					GENERAL MOTORS
55569449	VA0141579					GENERAL MOTORS
55569450	VE0141580					GENERAL MOTORS
55570709	VE0141582					GENERAL MOTORS
55570710	VA0141581					GENERAL MOTORS
55599817	VA0141708					GENERAL MOTORS
59112	VA0590093	VX 0250 AA	VS-1205	50.017.749	3038-A	FORD
5973128	VE0250053	VX 2400 AA	VS-2691	50.017.787	1175-ECSS	FIAT
5973129	VE0250059	VX 2221 AA	VS-2557	50.017.737	1383-EC	FIAT
59852970	VE0250001	VX 1628 AA	VS-993	50.017.171	1380-EC	FIAT
5HH-12111-00	VA0520199	VX 3285 AA			3950-AN	YAMAHA
5HH-12121-00	VE0520200	VX 3286 AA			3951-ESN	YAMAHA
5I-7738	VA0111409					CATERPILLAR
5I-7739	VE0111410					CATERPILLAR
5S-6449	VE0110142		VS-968		573-E	CATERPILLAR
5S-6452	VA0110143		VS-0969		573-A / 1573-ABS	CATERPILLAR
5VK1211100	VA0521736					YAMAHA
5VK1212100	VE0521737					YAMAHA
5VVE212100	VE0521721					YAMAHA
60811153	VA0250168	VX 4002 AA			3736-AC	ALFA ROMEO
60811153	VA0250168	VX 4002 AA			3736-AC	FIAT
60811154	VE0250169	VX 4003 AA			3737-ECBS / 3737-ECB	ALFA ROMEO
60811154	VE0250169	VX 4003 AA			3737-ECBS / 3737-ECB	FIAT
6010531901	VA0570250				3344-ACB	MERCEDES-BENZ
6010532827	VE0570230		VS-4892	50.017.847	23345-ECB / 23345-ECBS	MERCEDES-BENZ
6110530005	VE0480251				3659-EN / 4335-EN	MERCEDES-BENZ
6110530101	VA0480233				3658-AN / 4334-AN	MERCEDES-BENZ
622804603014	VA0130099	VX 0692 AA	VS-2696	50.017.767	3390-AC	MWM
641022	VA0140072	VX 2909 AA	VS-5094	50.004.483	3140-AC / 3774-AC	GENERAL MOTORS
641325	VE0140071	VX 2274 AA	VS-5086	50.004.484	23141-ECBS / 23141-EC / 3775-ECBS	GENERAL MOTORS
642763	VA0140015	VX 2332 AA	VS-4261	50.017.754	3136-AC / 4004-AC	GENERAL MOTORS
642890	VE0140014	VX 2333 AA	VS-4262	50.017.755	3137-ECB / 4005-EC / 3137-E	GENERAL MOTORS
675046-C4	VA0380226					INTERNATIONAL
676687-C4	VA0380228					INTERNATIONAL
676865-C4	VE0380227					INTERNATIONAL
6N-9915	VA0110145		VS-2401		3210-A	CATERPILLAR

ORIGINAL	MAHLE	TRW	EATON	KS	3B	LINHA MOTORA
6N-9916	VE0110146		VS-2402		23210-EBS	CATERPILLAR
7083242	VE0140370				3913-ECB / 3147-ECB	FIAT
7083246	VA0140086	VX 2331 AA	VS-4899	50.017.835	3146-AC / 3912-AC	FIAT
7085036	VA0251614				3912-AC	FIAT
7085037	VE0251615					FIAT
70910002	VE0570031	VX 0257 AA	VS-886	50.017.706	248-E C/P	PERKINS (MAXION)
70910011	VA0570111	VX 0440 AA	VS-1423	50.017.739	1498-ACP / 1498-ACP C/O	FORD
70910011	VA0570111	VX 0440 AA	VS-1423	50.017.739	1498-ACP / 1498-ACP C/O	PERKINS (MAXION)
70910012	VE0570112	VX 0441 AA	VS-1424	50.017.740	1498-ECP / 1498-ECP C/O	FORD
70910012	VE0570112	VX 0441 AA	VS-1424	50.017.740	1498-ECP / 1498-ECP C/O	PERKINS (MAXION)
70910017	VA0570038	VX 1912 AA	VS-2815	50.017.769	3392-AC / 249-AC C/O	GENERAL MOTORS
70910017	VA0570038	VX 1912 AA	VS-2815	50.017.769	3392-AC / 249-AC C/O	PERKINS (MAXION)
70910018	VE0570037	VX 1913 AA	VS-2816	50.017.770	3393-ECB / 1249-ECP C/O	GENERAL MOTORS
70910018	VE0570037	VX 1913 AA	VS-2816	50.017.770	3393-ECB / 1249-ECP C/O	PERKINS (MAXION)
70910038	VE0570122	VX 2298 AA	VS-2833	50.017.766	3389-ECB	GENERAL MOTORS
70910038	VE0570122	VX 2298 AA	VS-2833	50.017.766	3389-ECB	PERKINS (MAXION)
70910053	VA0570250				3344-ACB	FORD
70910053	VA0570250				3344-ACB	GENERAL MOTORS
70910053	VA0570250				3344-ACB	PERKINS (MAXION)
70910054	VE0570230		VS-4892	50.017.847	23345-ECB / 23345-ECBS	FORD
70910054	VE0570230		VS-4892	50.017.847	23345-ECB / 23345-ECBS	GENERAL MOTORS
70910061	VA0571369					PERKINS (MAXION)
70910076	VE0570230		VS-4892	50.017.847	23345-ECB / 23345-ECBS	PERKINS (MAXION)
70910080	VE0570232				3859-EBN / 3859-EC	FORD
70910080	VE0570232				3859-EBN / 3859-EC	PERKINS (MAXION)
70910081	VA0570231				3858-ACB	FORD
70910081	VA0570231				3858-ACB	PERKINS (MAXION)
7004.00600500.8	VA0060902					AGRALE
7004.00600600.6	VE0060906					AGRALE
7006.00600500.3	VA0060903				3326-A	AGRALE
7006.00600600.1	VE0060323				3327-E	AGRALE
7006680C1E	VA0131750					MWM
7006681C1E	VE0131751					MWM
7007.00600500.1	VA0060904				3924-A	AGRALE
7007.00600600.9	VE0060907				3925-E	AGRALE
7008.00600500.9	VC0060905					AGRALE
70910001/4	VA0570032	VX 0256 AA	VS-887	50.017.704	247-A C/P	PERKINS (MAXION)
70910025/ 35	VA0570123	VX 2299 AA	VS-2831	50.017.894	3342-AC	GENERAL MOTORS
70910025/ 35	VA0570123	VX 2299 AA	VS-2831	50.017.894	3342-AC	PERKINS (MAXION)
70910096 (70910037)	VA0570657				3388-ACB	GENERAL MOTORS
70910096 (70910037)	VA0570657				3388-ACB	PERKINS (MAXION)
7301820	VA0010211	VX 4011 AA			3510-ACB / 3624-AC	IVECO
7301820	VA0010211	VX 4011 AA			3510-ACB / 3624-AC	PEUGEOT
7323108	VE0140109	VX 0239 AA +15	VS-1481	50.017.723	1138-EG+15	GENERAL MOTORS
7547400	VA0250159	VX 2047 AB	VS-2873	50.017.745	1826-AC	FIAT
7574742	VE0250051	VX 2608 AA	VS-4531	50.017.762	3321-ECB	FIAT
7597080	VE0250158	VX 2392 AA	VS-2874	50.017.746	1826-ECB	FIAT
7581717000	VE0440583				1246-EC / 1381-EC C/O	PEUGEOT

ORIGINAL	MAHLE	TRW	EATON	KS	3B	LINHA MOTORA
7617500	VA0250054	VX 2399 AA	VS-2692	50.017.720	856-AC / 855-AC	FIAT
7633752	VE0250019	VX 2029 AA	VS-4898			FIAT
7722907	VA0250052	VX 2607 AA	VS-4530	50.017.761	3320-AC	FIAT
7735898	VA0250160	VX 4000 AA			3600-AC	FIAT
7735899	VE0250161	VX 4001 AA			3601-ECBS / 3601-ECB	FIAT
7766564	VA0250168	VX 4002 AA			3736-AC	ALFA ROMEO
7766564	VA0250168	VX 4002 AA			3736-AC	FIAT
7766565	VE0250169	VX 4003 AA			3737-ECBS / 3737-ECB	ALFA ROMEO
7766565	VE0250169	VX 4003 AA			3737-ECBS / 3737-ECB	FIAT
7700107602	VA0180124	VX 3101 AA			3598-A	RENAULT
7700855926	VA0180423				3452-A	RENAULT
7700855927	VE0180424				3453-EB	RENAULT
7700865449	VE0180396				3715-EB / 3717-ECB	RENAULT
7701469266	VA0180421				3620-A	RENAULT
7701469269	VE0180422				3621-EB	RENAULT
7701471279	VA0180415				3864-A	RENAULT
7701471280	VE0180416				3865-EB / 3865-E	RENAULT
7701471378	VA0180124	VX 3101 AA			3598-A	RENAULT
7701472124	VA0181746					RENAULT
7701472669	VA0181483				4080-AN / 421-A	RENAULT
7701472670	VE0181484				4081-EPN / 1421-EB	RENAULT
7701472986	VA0181606 (VA0180427)				3862-A	RENAULT
7701473004	VE0181607 (VE0180438)				3863-EB	RENAULT
7701473354	VE0180125	VX 3102 AA			3599-EB / 3599-E	RENAULT
7702220678	VA0180389				3308-AC	RENAULT
78MU-6505-B	VE0590092	VX 0757 AA	VS-1204	50.017.729	1326-E	FORD
78MU-6507-A	VA0590094	VX 0756 AA	VS-1132	50.017.708	326-A	FORD
7932582418	VA0440566				381-AC / 381-AC C/O	PEUGEOT
7N-0573	VE0111243					CATERPILLAR
7S6G.6505.AA	VE0590171	V76176A0			3063-ECB / 3063-EC	FORD
7W-8064	VA0110232		VS-3124		3614-AC	CATERPILLAR
7W-8064	VA0110232		VS-3124		3614-AC	GENERAL MOTORS
800558	VA0230119	VX 0023 AA	VS-0016	50.017.759	3272-A	FORD WILLYS
800558	VE0230118	VX 0088 AA	VS-770	50.017.760	3273-E / 3272-E	FORD WILLYS
8148574	VE0710201	VX 4018 AA	VS-4968	50.017.667	3915-ECB	VOLVO
8194223	VA0710063	VX 0588 AB	VS-4934	50.017.126	860-AC / 860-AC C/O	VOLVO
8194224	VE0710064	VX 1085 AB	VS-4936	50.017.127	1861-ECP / 1861-ECB C/O	VOLVO
8200054762	VE0180125	VX 3102 AA			3599-EB / 3599-E	RENAULT
8200708662	VE0180310			50.017.936	3527-E / 4185-EN	RENAULT
8200708663	VA0180393			50.017.935	3526-A / 4184-AN	RENAULT
836646356	VA0310273					VALMET / VALTRA
836646357	VE0310274					VALMET / VALTRA
84AU-6505-A	VE0590042	VX 1319 AA	VS-2465	50.017.748	3037-EP	FORD
84AU-6507-A	VA0590043	VX 1320 AA	VS-2489	50.017.747	3036-A	FORD
84AU-6507-B	VA0590044	VX 1321 AA	VS-1492	50.017.797	814-AC / 816-AC	FORD
84AU-6507-B	VA0590044	VX 1321 AA	VS-1492	50.017.797	814-AC / 816-AC	VOLKSWAGEN
87802264	VA1961403					CASE
87802266	VE1961404					CASE
89BM-6507AA	VA0590172	VX 4009 AA			3054-AC	FORD
89BM-6507AA	VA0590181	V76175A0		50.017.854	3052-AC	FORD
8H-1993	VA0110140		VS-0696			CATERPILLAR
8H-1994	VE0110141		VS-460			CATERPILLAR

ORIGINAL	MAHLE	TRW	EATON	KS	3B	LINHA MOTORA
8N-0875	VE0110144		VS-1406		1573-EBS	CATERPILLAR
90136615	VA0140114 0,076				344-AC+3	GENERAL MOTORS
90136616	VA0140114 0,381				344-AC+15	GENERAL MOTORS
90136617	VA0140114 0,762				344-AC+30	GENERAL MOTORS
90136622	VE0140113 0,076				1344-ECP+3	GENERAL MOTORS
90136624	VE0140113 0,762				1344-ECP+30	GENERAL MOTORS
90215492	VA0140086	VX 2331 AA	VS-4899	50.017.835	3146-AC / 3912-AC	GENERAL MOTORS
90220119	VA0140040	VX 1699 AA	VS-1980	50.017.752	3109-AC / 4056-AC	GENERAL MOTORS
90232975	VA0251614				3912-AC	FIAT
90323518	VA0140015	VX 2332 AA	VS-4261	50.017.754	3136-AC / 4004-AC	GENERAL MOTORS
90.323.523	VE0140014	VX 2333 AA	VS-4262	50.017.755	3137-ECB / 4005-EC / 3137-E	GENERAL MOTORS
90323756	VE0140039	VX 2059 AA	VS-1984	50.017.791	23109-ECP / 23109-EC / 4031-EPN / 4057-EX	GENERAL MOTORS
90324412	VE0140085	VX 2334 AA	VS-4900	50.017.836	3147-ECB	GENERAL MOTORS
90410813	VE0140071	VX 2274 AA	VS-5086	50.004.484	23141-ECBS / 23141-EC / 3775-ECBS	GENERAL MOTORS
90412277	VA0140072	VX 2909 AA	VS-5094	50.004.483	3140-AC / 3774-AC	GENERAL MOTORS
90412712	VA0140076	VX 2463 AA	VS-4901	50.017.837	3138-AC	GENERAL MOTORS
90412974	VE0140075	VX 2925 AA		50.017.838	3139-EC	GENERAL MOTORS
9060500326	VA0480244	VX 3004 AB			3846-AC	MERCEDES-BENZ
9060500327	VE0480245				3847-ECB / 4109-ECB	MERCEDES-BENZ
9060500827	VE0481487				4109-ECB	MERCEDES-BENZ
90136614/ 6613	VA0140114	VX 1220 AA	VS-1415	50.017.713	344-AC / 3108-AC	GENERAL MOTORS
90136620/ 6621	VE0140113	VX 1221 AA / VX 2034 AA	VS-1658	50.017.736	1344-ECP / 23108-ECPS	GENERAL MOTORS
90TM-6505-AB	VE0590276				3043-ECP	FORD
9153501680	VA0441040					PEUGEOT
9153501780	VA0440551				3301-AC / 3304-A	CITROËN
9153501780	VA0440551				3301-AC / 3304-A	PEUGEOT
9153501880	VE0441382					PEUGEOT
9153501980	VE0440585				23301-ECB / 3303-EC	CITROËN
9153501980	VE0440585				23301-ECB / 3303-EC	PEUGEOT
928M-650-F2-A	VA0590180		VS-5294		3066-AC / 3814-AC / 3082-AC / 3068-AC	FORD
93248325	VA0140026	VX 2996 AA			3578-AC	GENERAL MOTORS
93248326	VE0140025	VX 2997 AA			3579-ECB / 3579-EC	GENERAL MOTORS
93333561	VA0140226	VX 3176 AA			4054-AC	GENERAL MOTORS
93333562	VE0140248	VX 3177 AA			4055-EC	GENERAL MOTORS
93361392	VA0141431					GENERAL MOTORS
93382956	VA0141705					GENERAL MOTORS
93382957	VE0141706					GENERAL MOTORS
93399245	VA0141396	V75591A0			4006-AC	GENERAL MOTORS
93399246	VA0251614				3912-AC	FIAT
93399247	VE0141397	V76379A0			4007-ECB / 4007-EC	GENERAL MOTORS
93399248	VE0251615					FIAT
9350111780	VE0440581				23241-ECP / 23241-ECP C/O	GENERAL MOTORS
9350111780	VE0440581				23241-ECP / 23241-ECP C/O	PEUGEOT
9350111580/ 480	VA0440567				3241-AC / 3241-AC C/O	GENERAL MOTORS
9350111580/ 480	VA0440567				3241-AC / 3241-AC C/O	PEUGEOT
94621041	VA0140084 0,152				332-AC+06	GENERAL MOTORS

ORIGINAL	MAHLE	TRW	EATON	KS	3B	LINHA MOTORA
94621045	VE0140083 0,076				1332-ECP+3	GENERAL MOTORS
94621047	VE0140083 0,152				1332-ECP+06	GENERAL MOTORS
94621607	VA0140084 0,304				332-AC+12	GENERAL MOTORS
94621609	VE0140083 0,304				1332-ECP+12	GENERAL MOTORS
94621039/ 1040	VA0140084 0,076				332-AC+3	GENERAL MOTORS
94621104/ 1038	VA0140084	VX 1550 AA	VS-1299	50.017.710	332-AC	GENERAL MOTORS
94621105/ 1043	VE0140083	VX 0365 AC	VS-1302	50.017.732	1332-ECP	GENERAL MOTORS
948M-6505-D2A	VE0590182		VS-5295		3067-ECB / 3069- ECB / 3067-EC / 3815-EC	FORD
96101886	VA0440575				4010-A	CITROËN
96101886	VA0440575				4010-A	PEUGEOT
96101887	VE0440596				4011-ECB	CITROËN
96101887	VE0440596				4011-ECB	PEUGEOT
96172597	VA0440571					CITROËN
96172597	VA0440571					PEUGEOT
96172795	VE0440590					CITROËN
96172795	VE0440590					PEUGEOT
96183535	VA0440575				4010-A	CITROËN
96183535	VA0440575				4010-A	PEUGEOT
962981180	VE0440297				3541-ECB / 3541-EC	PEUGEOT
1371137031	VA0631738					TOYOTA
1371537060	VE0631739					TOYOTA
9605936180	VA0440557				3542-A	PEUGEOT
9605936280	VE0440589				3543-ECB	PEUGEOT
9626052980	VA0440569				3576-A	PEUGEOT
9628943380	VA0440561				3540-A	PEUGEOT
9629861180	VE0440301				3577-ECB	PEUGEOT
9639417980	VE0760058	VX 0616 AA	VS-1367	50.017.123	1374-ECSS	SCANIA
9675424780	VA0441689					CITROËN
9675424980	VE0441690					CITROËN
9805490080	VA0441701					CITROËN
9805490080	VA0441701					PEUGEOT
9805490180	VE0441702					CITROËN
9805490180	VE0441702					PEUGEOT
97531046	VE0440593				4035-EPN	CITROËN
97531046	VE0440593				4035-EPN	PEUGEOT
97531079	VA0440572				4034-AN	CITROËN
97531079	VA0440572				4034-AN	PEUGEOT
97BM-6505-AA	VE0590173	VX 4010 AA			3053-ECB	FORD
97MM6507BB2B	VA0590179	VX 4006 AA		50.017.870	3064-AC / 3090-AC	FORD
98468338	VA0250513				3586-ACB	CITROËN
98468338	VA0250513				3586-ACB	FIAT
98468338	VA0250513				3586-ACB	IVECO
98468338	VA0250513				3586-ACB	PEUGEOT
98468338	VA0250513				3586-ACB	RENAULT
99432837EC54-0652	VE0010212	VX 4014 AA			4041-ECB / 3587- ECB / 3625-EC	IVECO
99432837EC54-0652	VE0010212	VX 4014 AA			4041-ECB / 3587- ECB / 3625-EC	PEUGEOT
9.2260.460.0054	VA0130011	VX 0304 AA	VS-1134	50.017.717	565-AC	FORD
9.2260.460.0054	VA0130011	VX 0304 AA	VS-1134	50.017.717	565-AC	MWM
9.3080.460.0024	VE0130010	VX 0305 AA	VS-1135	50.017.199	1565-ECB / 3045- ECP / 1565-ECP	FORD
9.3080.460.0024	VE0130010	VX 0305 AA	VS-1135	50.017.199	1565-ECB / 3045- ECP / 1565-ECP	MWM
9.4070.460.0024	VE0130278				3547-ECBS / 3547- ECB	GENERAL MOTORS
9.4070.460.0024	VE0130278				3547-ECBS / 3547- ECB	MWM

ORIGINAL	MAHLE	TRW	EATON	KS	3B	LINHA MOTORA
9.4070.460.0034	VA0130277				3546-AC	GENERAL MOTORS
9.4070.460.0034	VA0130277				3546-AC	MWM
9.6120.460.0024	VA0130933					MWM
9.229.0.460.003.4	VE0130098	VX 1975 AA	VS-2695	50.017.768	3391-ECB	MWM
9.610.0.460.002.4	VE0130100	VX 2124 AA	VS-2824	50.017.844	23423-ECBS / 23423-ECB	MWM
9.610.0.460.002.4	VE0130100	VX 2124 AA	VS-2824	50.017.844	23423-ECBS / 23423-ECB	VOLKSWAGEN
9.610.0.460.003.4	VA0130101	VX 2123 AA	VS-2825	50.017.844	3422-AC	MWM
9.610.0.460.003.4	VA0130101	VX 2123 AA	VS-2825	50.017.844	3422-AC	VOLKSWAGEN
9.612.0.460.001.4	VE0130239					MWM
9.612.8.460.001.4	VE0130239					MWM
9L-7682	VA0110235				561-A	CATERPILLAR
9L-7683	VE0110234				1561-EB	CATERPILLAR
A4420160391	VC0481565				3693-E	MERCEDES-BENZ
A4570500327	VE0481437				4097-ECB	MERCEDES-BENZ
A5410160791	VC0481345				3875-EC	MERCEDES-BENZ
A5410530101	VA0481436					MERCEDES-BENZ
A6510500127	VE0481564					MERCEDES-BENZ
A6510530101	VA0481563					MERCEDES-BENZ
A9060160791	VC0481344				3874-EC	MERCEDES-BENZ
AM5G-6505-AB	VE0591472				4345-EN	FORD
AS65-6507-AA	VA0591474					FORD
B-27220	VE0230118	VX 0088 AA	VS-770	50.017.760	3273-E / 3272-E	JEEP
BH5T-6505-AA	VE0211733					CUMMINS
BH5T-6507-AA	VA0211732					CUMMINS
BRA0007600	VA0521720					YAMAHA
CM5Z/6507/A	VA0591722					FORD
E3BG/6505/BB	VE0591723					FORD
F57Z-6505-A	VE0591462				3071-ECP	FORD
F57Z-6507-A	VA0591461				3070-AC	FORD
F77Z-6505-AA	VE0590276				3043-ECP	FORD
K710-12-111	VA2110229		VS-5284	50.017.866	3298-AN	KIA MOTORS
K710-12-111	VA2110229		VS-5284	50.017.866	3298-AN	MAZDA
K710-12-121	VE2110249				3299-EN	KIA MOTORS
K710-12-121	VE2110249				3299-EN	MAZDA
MD-085253	VA1950825				4032-AN	MITSUBISHI
MD-085254	VE1950826				4033-EPN	MITSUBISHI
MD-088811	VA1950234					MITSUBISHI
MD-088812	VE1950235					MITSUBISHI
MD-159502	VA1950261				3464-AN	MITSUBISHI
MD-162422	VA1951571					MITSUBISHI
MD-162423	VE1951572					MITSUBISHI
MD-162616	VE1950828					MITSUBISHI
MD-197106	VE1950262				3465-EBM / 3465-EBN	MITSUBISHI
MD198404	VA1950223				3720-AN	MITSUBISHI
MD-198406	VE1950224				3721-EBN	MITSUBISHI
MD-373237	VE1950238					MITSUBISHI
ME-202687	VA1950247				3580-AN	MITSUBISHI
ME-202688	VE1950246				3581-EBN	MITSUBISHI
ME-203101	VA1950236				4310-AN	MITSUBISHI
ME-203102	VE1950237				4311-EN	MITSUBISHI
OFE 3P 12121	VE2111420					HYSTER
OFE 3P 12121	VE2111420					KIA MOTORS
OFE 3P 12121	VE2111420					YALE
OK 9541 2111	VA2111419					HYSTER
OK 9541 2111	VA2111419					KIA MOTORS
OK 9541 2111	VA2111419					YALE

ORIGINAL	MAHLE	TRW	EATON	KS	3B	LINHA MOTORA
OK63C-12-121	VE2110188		VS-5297		3827-EBN	KIA MOTORS
OK65D12111	VA2110187		VS-5296		3828-AN	KIA MOTORS
ON01-12-111	VA2110185		VS-5281	50.017.850	3548-APN / 3826-AN	KIA MOTORS
ON01-12-111	VA2110185		VS-5281	50.017.850	3548-APN / 3826-AN	MAZDA
ON01-12-121	VE2110186		VS-5282	50.017.851	3548-EBN / 3549-EBN	KIA MOTORS
ON01-12-121	VE2110186		VS-5282	50.017.851	3548-EBN / 3549-EBN	MAZDA
R-90692	VE0430542				3619-ECB	JOHN DEERE
R-97490	VA0430546 0,381					JOHN DEERE
R-97492	VE0430542 0,381					JOHN DEERE
R-98062	VA0430546				3618-AC	JOHN DEERE
X56G6505B2A	VE0590178			50.017.801	3065-EN / 3091-ECB	FORD
XS6E6505AB	VE0590171	V76176A0			3063-ECB / 3063-EC	FORD
XS6E6505BB	VE0590175	V74470A0	VS-5127		3093-ECBS / 3093-EC	FORD
XS6E6507AA	VA0590170	V76175A0			3062-AC	FORD
YS4E.6505.BA	VE0590175	V74470A0	VS-5127		3093-ECBS / 3093-EC	FORD
YS4E-6507-AB	VA0591473					FORD

TRW	MAHLE	ORIGINAL	EATON	KS	3B	LINHA MOTORA
V74469A0	VA0590174		VS-4939		3092-AC	FORD
V74470A0	VE0590175	XS6E6505BB / YS4E.6505.BA	VS-5127		3093-ECBS / 3093-EC	FORD
V75152A0	VA0700267	032.109.601.P				VOLKSWAGEN
V75153A0	VE0700268	032.109.611.Q / 032.109.611.N			3887-EB	VOLKSWAGEN
V75154A0	VA0701421	030.109.601.AS			3868-A	VOLKSWAGEN
V75155A0	VE0701422	030.109.611.AG			3869-EB	VOLKSWAGEN
V75591A0	VA0141396	93399245			4006-AC	GENERAL MOTORS
V76175A0	VA0590170	XS6E6507AA			3062-AC	FORD
V76175A0	VA0590181	89BM-6507AA		50.017.854	3052-AC	FORD
V76176A0	VE0590171	XS6E6505AB / 7S6G.6505.AA			3063-ECB / 3063-EC	FORD
V76379A0	VE0141397	93399247			4007-ECB / 4007-EC	GENERAL MOTORS
V76562A0	VA0250271	55195497			3956-AC	FIAT
V76563A0	VE0250272	55195498			3997-ECB / 3997-EC / 3957-ECB	FIAT
VX 0013 AA	VA0140106	3695455 / 3758810	VS-0040	50.017.700	135-A	GENERAL MOTORS
VX 0023 AA	VA0230119	800558	VS-0016	50.017.759	3272-A	FORD WILLYS
VX 0087 AA	VE0570034	0910041 / 0910073	VS-457	50.017.727	1251-EPMF / 251 E	FORD
VX 0087 AA	VE0570034	0910041 / 0910073	VS-457	50.017.727	1251-EPMF / 251 E	PERKINS (MAXION)
VX 0088 AA	VE0230118	800558	VS-770	50.017.760	3273-E / 3272-E	FORD WILLYS
VX 0088 AA	VE0230118	B-27220	VS-770	50.017.760	3273-E / 3272-E	JEEP
VX 0090 AA	VA0570033	0910030 / 0910069	VS-1754	50.017.707	250-AMF / 250 A	FORD
VX 0090 AA	VA0570033	0910030 / 0910069	VS-1754	50.017.707	250-AMF / 250 A	PERKINS (MAXION)
VX 0091 AA	VE0570036	0910002	VS-618	50.017.705	248-E / 248-E C/O	PERKINS (MAXION)
VX 0092 AB	VA0570035	31431261 / 0910001	VS-620		247-A / 247-A C/O	PERKINS (MAXION)
VX 0201 AA	VE0700049	040.109.612.2	VS-850	50.017.788	1452-E	VOLKSWAGEN
VX 0219 AB - STD	VE0140105	3724778 / 3989084	VS-1201	50.017.721	1138-EG / 1138 E / 1138 E STD	GENERAL MOTORS
VX 0220 AB	VA0140104	2638552 / 3774052	VS-1202	50.017.701	137-A / 137 AG	GENERAL MOTORS
VX 0221 AA +3	VA0140108	2787538 / 3786360	VS-865	50.017.702	137-A+3 / 137 AG+3	GENERAL MOTORS
VX 0222 AA +15	VA0140110	3786361 / 3995685	VS-866	50.017.703	137-A+15 / 137 AG+15	GENERAL MOTORS
VX 0238 AA +3	VE0140107	3732758	VS-1335	50.017.722	1138-EG+3	GENERAL MOTORS
VX 0239 AA +15	VE0140109	7323108 / 3995603	VS-1481	50.017.723	1138-EG+15	GENERAL MOTORS
VX 0246 AE	VA0480004	3520530101	VS-1177	50.017.042	226-AC / 226-AC C/O	MERCEDES-BENZ
VX 0250 AA	VA0590093	59112	VS-1205	50.017.749	3038-A	FORD
VX 0256 AA	VA0570032	70910001/4	VS-887	50.017.704	247-A C/P	PERKINS (MAXION)
VX 0257 AA	VE0570031	70910002	VS-886	50.017.706	248-E C/P	PERKINS (MAXION)
VX 0282 AB	VE0480003	3520531505	VS-1178	50.017.049	1226-ECB / 1226-ECB C/O	MERCEDES-BENZ
VX 0304 AA	VA0130011	9.2260.460.0054	VS-1134	50.017.717	565-AC	FORD
VX 0304 AA	VA0130011	9.2260.460.0054	VS-1134	50.017.717	565-AC	MWM
VX 0305 AA	VE0130010	9.3080.460.0024	VS-1135	50.017.199	1565-ECB / 3045-ECP / 1565 ECP	FORD
VX 0305 AA	VE0130010	9.3080.460.0024	VS-1135	50.017.199	1565-ECB / 3045-ECP / 1565 ECP	MWM
VX 0365 AC	VE0140083	94621105/ 1043	VS-1302	50.017.732	1332-ECP	GENERAL MOTORS
VX 0366 AD	VE0700022	311.109.612	VS-1167	50.017.738	1453-E	VOLKSWAGEN
VX 0383 AA	VA0480048	3460530001	VS-1157	50.017.044	229-AC / 229-AC C/O	MERCEDES-BENZ
VX 0384 AA	VE0480047	3460530005	VS-1158	50.017.056	1229-EC / 1229-ECP C/O	MERCEDES-BENZ
VX 0428 AF	VA0700061	056.109.601.A	VS-981	50.017.392	422-AC / 422-A	VOLKSWAGEN
VX 0429 AA	VE0700062	056.109.611.A	VS-980	50.017.072	1422-EB	VOLKSWAGEN
VX 0434 AG	VA0700020	040.109.601.2	VS-869	50.017.716	452-A / 453-A	VOLKSWAGEN
VX 0435 AF	VA0700050	040.109.601.1	VS-868	50.017.715	422-A / 452-A	VOLKSWAGEN
VX 0440 AA	VA0570111	31431723 / 70910011	VS-1423	50.017.739	1498-ACP / 1498-ACP C/O	FORD
VX 0440 AA	VA0570111	31431723 / 70910011	VS-1423	50.017.739	1498-ACP / 1498-ACP C/O	PERKINS (MAXION)
VX 0441 AA	VE0570112	70910012	VS-1424	50.017.740	1498-ECP / 1498-ECP C/O	FORD
VX 0441 AA	VE0570112	70910012	VS-1424	50.017.740	1498-ECP / 1498-ECP C/O	PERKINS (MAXION)
VX 0514 AB	VA0250002	43401180	VS-992	50.017.170	380-AC	FIAT

TRW	MAHLE	ORIGINAL	EATON	KS	3B	LINHA MOTORA
VX 0588 AB	VA0710063	469240 / 4675002 / 8194223	VS-4934	50.017.126	860-AC / 860-AC C/O	VOLVO
VX 0602 AA	VA0570024	31431315	VS-1160	50.017.792	249-AC	GENERAL MOTORS
VX 0602 AA	VA0570024	31431315	VS-1160	50.017.792	249-AC	PERKINS (MAXION)
VX 0604 AA	VE0570023	31431851	VS-1161	50.017.793	1249-ECP / 1499-ECP STD	GENERAL MOTORS
VX 0604 AA	VE0570023	31431851	VS-1161	50.017.793	1249-ECP / 1499-ECP STD	PERKINS (MAXION)
VX 0616 AA	VE0760058	232018 / 9639417980	VS-1367	50.017.123	1374-ECSS	SCANIA
VX 0692 AA	VA0130099	622804603014	VS-2696	50.017.767	3390-AC	MWM
VX 0756 AA	VA0590094	78MU-6507-A	VS-1132	50.017.708	326-A	FORD
VX 0757 AA	VE0590092	78MU-6505-B	VS-1204	50.017.729	1326-E	FORD
VX 0785 AB	VE0700021	43109611	VS-1317	50.017.728	1305-ECP	VOLKSWAGEN
VX 0786 AA	VA0510045	14711-383-000	VS-4906	50.017.778	23293-AP	HONDA
VX 0787 AA	VE0510046	14721-383-000	VS-4918	50.017.779	23293-EP	HONDA
VX 0846 AA	VA0480091	3550530001	VS-1136	50.017.119	3262-AC / 843-AC / 843-AC C/O	MERCEDES-BENZ
VX 0847 AA	VE0480090	3550530005	VS-1137	50.017.120	3263-ECB / 1843-ECP / 1843-ECP C/O	MERCEDES-BENZ
VX 0989 AA	VA0510115	14711-440-0030-BR	VS-4985		3408-AC	HONDA
VX 0990 AA	VE0510117	14721-437-0000	VS-4997	50.017.781	23409-ECSS / 23409-ECB	HONDA
VX 1085 AB	VE0710064	467855 / 8194224	VS-4936	50.017.127	1861-ECP / 1861-ECB C/O	VOLVO
VX 1202 AA	VA0700078	049.109.601.F	VS-1356	50.017.385	825-A	VOLKSWAGEN
VX 1203 AA	VE0700077	049.109.611.F	VS-1357	50.017.386	1825-E	VOLKSWAGEN
VX 1209 AA	VE0700081	068.109.611.C	VS-1359	50.017.017	1303 ECB / 1303-EC	VOLKSWAGEN
VX 1210 AA	VA0700082	068.109.601.C	VS-1358	50.017.016	303-AC	VOLKSWAGEN
VX 1220 AA	VA0140114	90136614/ 6613	VS-1415	50.017.713	344-AC / 3108-AC	GENERAL MOTORS
VX 1221 AA	VE0140113	90136620/ 6621	VS-1658	50.017.736	1344-ECP / 23108-ECPS	GENERAL MOTORS
VX 1319 AA	VE0590042	84AU-6505-A	VS-2465	50.017.748	3037-EP	FORD
VX 1320 AA	VA0590043	84AU-6507-A	VS-2489	50.017.747	3036-A	FORD
VX 1321 AA	VA0590044	84AU-6507-B / 0291096011	VS-1492	50.017.797	814-AC / 816-AC	FORD
VX 1321 AA	VA0590044	84AU-6507-B / 0291096011	VS-1492	50.017.797	814-AC / 816-AC	VOLKSWAGEN
VX 1368 AA	VA0700017	035.109.601.C	VS-1646	50.017.396	815-AC	VOLKSWAGEN
VX 1455 AC	VE0710120	468303	VS-4938	50.017.125	1582-ECP	VOLVO
VX 1472 AA	VE0700016	035.109.611.F	VS-1696	50.017.397	1815-EB / 1815 EGX	FORD
VX 1472 AA	VE0700016	035.109.611.F	VS-1696	50.017.397	1815-EB / 1815 EGX	VOLKSWAGEN
VX 1473 AA	VA0510116	14711-397-6300	VS-4917	50.017.772	3408-AC	HONDA
VX 1550 AA	VA0140084	94621104/ 1038	VS-1299	50.017.710	332-AC	GENERAL MOTORS
VX 1565 AA	VA0480080	3450537001	VS-1129	50.017.757	843-AC / 3262-AC / 3262-AC C/O	MERCEDES-BENZ
VX 1566 AA	VE0480079	3450500127/ 7005	VS-1128	50.017.758	1843-ECP / 3263-ECB / 3263-ECB C/O	MERCEDES-BENZ
VX 1594 AA	VA0710121	468302	VS-4937	50.017.124	582-AC	VOLVO
VX 1628 AA	VE0250001	59852970	VS-993	50.017.171	1380-EC	FIAT
VX 1699 AA	VA0140040	90220119	VS-1980	50.017.752	3109-AC / 4056-AC	GENERAL MOTORS
VX 1784 AA	VA0760013	352211 / 352212 / 294674 / 289483	VS-4905	50.017.789	1374-ACB 20° / 23394-ACBS / 23394-ACB	SCANIA
VX 1812 AB	VA0590066	035109601G	VS-4762	50.017.826	3312-A	FORD
VX 1812 AB	VA0590066	035109601G	VS-4762	50.017.826	3312-A	VOLKSWAGEN
VX 1813 AA	VE0590065	026 109 611 A	VS-2574	50.017.827	23238-EB	FORD
VX 1813 AA	VE0590065	026 109 611 A	VS-2574	50.017.827	23238-EB	VOLKSWAGEN
VX 1912 AA	VA0570038	70910017	VS-2815	50.017.769	3392-AC / 249-AC C/O	GENERAL MOTORS
VX 1912 AA	VA0570038	70910017	VS-2815	50.017.769	3392-AC / 249-AC C/O	PERKINS (MAXION)
VX 1913 AA	VE0570037	70910018	VS-2816	50.017.770	3393-ECB / 1249-ECP C/O	GENERAL MOTORS
VX 1913 AA	VE0570037	70910018	VS-2816	50.017.770	3393-ECB / 1249-ECP C/O	PERKINS (MAXION)
VX 1947 AA	VA0590067	026109601D	VS-2639		3602-A	FORD
VX 1947 AA	VA0590067	026109601D	VS-2639		3602-A	VOLKSWAGEN
VX 1975 AA	VE0130098	9.229.0.460.003.4	VS-2695	50.017.768	3391-ECB	MWM
VX 2009 AA	VA0510070	14711-KW1-9000-R	VS-4995	50.017.785	1001-AC	HONDA
VX 2018 AA	VE0510069	14721-KW1-9000-R	VS-4996	50.017.786	1002-ECB	HONDA

TRW	MAHLE	ORIGINAL	EATON	KS	3B	LINHA MOTORA
VX 2019 AA	VE0760012	1100997 / 1360834 / 232018	VS-5166	50.017.790	1374-ECSS / 23395-ECSS / 23395-ECS	SCANIA
VX 2028 AA	VA0250018	46470637 / 46559031	VS-4897	50.017.756	3234-AC	FIAT
VX 2029 AA	VE0250019	7633752 / 46470638	VS-4898			FIAT
VX 2034 AA	VA0140041	52285384	VS-1660	50.017.753	3045-ECP / 3110-AC	GENERAL MOTORS
VX 2034 AA	VE0140113	90136620/ 6621	VS-1658	50.017.736	1344-ECP / 23108-ECPS	GENERAL MOTORS
VX 2047 AB	VA0250159	7547400	VS-2873	50.017.745	1826-AC	FIAT
VX 2059 AA	VE0140039	90323756	VS-1984	50.017.791	23109-ECP / 23109-EC / 4031-EPN / 4057-EX	GENERAL MOTORS
VX 2123 AA	VA0130101	9.610.0.460.003.4	VS-2825	50.017.844	3422-AC	MWM
VX 2123 AA	VA0130101	9.610.0.460.003.4	VS-2825	50.017.844	3422-AC	VOLKSWAGEN
VX 2124 AA	VE0130100	9.610.0.460.002.4	VS-2824	50.017.844	23423-ECBS / 23423-ECB	MWM
VX 2124 AA	VE0130100	9.610.0.460.002.4	VS-2824	50.017.844	23423-ECBS / 23423-ECB	VOLKSWAGEN
VX 2220 AA	VA0250060	4239917 / 4460697	VS-2556	50.017.714	175-AC / 383-AC	FIAT
VX 2221 AA	VE0250059	5973129	VS-2557	50.017.737	1383-EC	FIAT
VX 2274 AA	VE0140071	90410813 / 641325	VS-5086	50.004.484	23141-ECBS / 23141-EC / 3775-ECBS	GENERAL MOTORS
VX 2298 AA	VE0570122	70910038	VS-2833	50.017.766	3389-ECB	GENERAL MOTORS
VX 2298 AA	VE0570122	70910038	VS-2833	50.017.766	3389-ECB	PERKINS (MAXION)
VX 2299 AA	VA0570123	70910025/ 35	VS-2831	50.017.894	3342-AC	GENERAL MOTORS
VX 2299 AA	VA0570123	70910025/ 35	VS-2831	50.017.894	3342-AC	PERKINS (MAXION)
VX 2324 AA	VA0510029	14711-KYO-8901-R	VS-4993	50.017.774	3416-AC	HONDA
VX 2325 AA	VE0510030	14721-KYO-8901-R	VS-4994	50.017.783	23417-ECBS / 23417-ECB	HONDA
VX 2331 AA	VA0140086	7083246 / 90215492	VS-4899	50.017.835	3146-AC / 3912-AC	FIAT
VX 2331 AA	VA0140086	90215492 / 7083246	VS-4899	50.017.835	3146-AC / 3912-AC	GENERAL MOTORS
VX 2332 AA	VA0140015	90323518 / 642763	VS-4261	50.017.754	3136-AC / 4004-AC	GENERAL MOTORS
VX 2333 AA	VE0140014	90.323.523 / 642890	VS-4262	50.017.755	3137-ECB / 4005-EC / 3137-E	GENERAL MOTORS
VX 2334 AA	VE0140085	90324412	VS-4900	50.017.836	3147-ECB	GENERAL MOTORS
VX 2387 AA	VA0480056	4220500226 / 4420500526	VS-2520	50.017.046	1839-ACB / 1839-ACB C/O	MERCEDES-BENZ
VX 2388 AA	VA0480006	3760530101	VS-1814	50.017.391	3260-ACB / 3260-ACB 20 C/O / 2026-AC 30 C/O	MERCEDES-BENZ
VX 2389 AA	VE0480005	3660500227	VS-2535	50.017.390	23260-ECB / 23260-ECB C/O / 21226-ECB C/O	MERCEDES-BENZ
VX 2390 AA (VA1648A)	VA0480096	3760530001	VS-2587	50.017.389	2026-AC 30°	MERCEDES-BENZ
VX 2391 AA (VA1751A)	VE0480097	3760500027 / 3660500027	VS-2091	50.017.055	23260-ECB / 21226-ECB / 23260 ECB+0,4	MERCEDES-BENZ
VX 2392 AA	VE0250158	7597080	VS-2874	50.017.746	1826-ECB	FIAT
VX 2399 AA	VA0250054	7617500	VS-2692	50.017.720	856-AC / 855-AC	FIAT
VX 2400 AA	VE0250053	5973128	VS-2691	50.017.787	1175-ECSS	FIAT
VX 2463 AA	VA0140076	90412712	VS-4901	50.017.837	3138-AC	GENERAL MOTORS
VX 2600 AA	VE0480055	4220500127 / 4420500227	VS-4362		1839-ECB / 1839-ECD / 1839-ECB C/O	MERCEDES-BENZ
VX 2607 AA	VA0250052	7722907	VS-4530	50.017.761	3320-AC	FIAT
VX 2608 AA	VE0250051	7574742	VS-4531	50.017.762	3321-ECB	FIAT
VX 2750 AA	VA0760103	1515743 / 1333230		50.009.016	3662 ACB / 3663-ECBS / 4242-AX	SCANIA
VX 2751 AA	VE0760102	1328537			3663-ECBS / 4243-EX	SCANIA
VX 2811 AA	VA0480007	366.050.1226	VS-2770	50.017.794	3260-ACB-20° / 3260-ACB C/O	MERCEDES-BENZ
VX 2875 AA	VA0700009	036.109.601.R	VS-5127	50.017.860	3508-A	VOLKSWAGEN
VX 2909 AA	VA0140072	90412277 / 641022	VS-5094	50.004.483	3140-AC / 3774-AC	GENERAL MOTORS
VX 2923 AA	VA0700088	048.109.601.E	VS-4510	50.004.599	3484-AB / 815-A / 3484-A / 3486-A / 3238-A / 3310-A	VOLKSWAGEN
VX 2925 AA	VE0140075	90412974		50.017.838	3139-EC	GENERAL MOTORS
VX 2930 AA	VA0700028	030.109.601.AC	VS-4919	50.017.849	3512-A	VOLKSWAGEN
VX 2931 AA	VE0700027	030.109.611.AC	VS-4856	50.017.853	3513-EB	VOLKSWAGEN

TRW	MAHLE	ORIGINAL	EATON	KS	3B	LINHA MOTORA
VX 2951 AB	VE0480194	5410500227	VS-5225		3857-ECB	MERCEDES-BENZ
VX 2975 AA	VA0700089	078.109.601.B	VS-4546	50.004.600	1718 A / 3486-A / 3313-A	VOLKSWAGEN
VX 2976 AA	VE0700087	048.109.611.C	VS-4511	50.004.601	3485-EBS / 1815-E / 3485-EB	VOLKSWAGEN
VX 2989 AA	VE0700008	036.109.611.J	VS-5223	50.017.861	3509-EB / 3509-E	VOLKSWAGEN
VX 2996 AA	VA0140026	93248325			3578-AC	GENERAL MOTORS
VX 2997 AA	VE0140025	93248326			3579-ECB / 3579-EC	GENERAL MOTORS
VX 3004 AB	VA0480244	9060500326			3846-AC	MERCEDES-BENZ
VX 3042 AA	VE0510127	14721-GF6-0101			1011-ESN	HONDA
VX 3043 AA	VA0510126	14711-GN5-9130		50.017.464	1010-A	HONDA
VX 3066 AA	VA0700252	032.109.601.M	VS-4893	50.017.846	3886-A	VOLKSWAGEN
VX 3090 AA	VA0700074	036.109.601.AE			3870-A	VOLKSWAGEN
VX 3091 AA	VE0700073	036.109.611.T			3871-EB	VOLKSWAGEN
VX 3092 AA	VE0700253	032.109.611.L			3887-E	VOLKSWAGEN
VX 3101 AA	VA0180124	7701471378 / 7700107602			3598-A	RENAULT
VX 3102 AA	VE0180125	7701473354 / 8200054762			3599-EB / 3599-E	RENAULT
VX 3128 AA	VA0250162	46553046	VS-5087		3800-AC	FIAT
VX 3129 AA	VE0250167	46553047	VS-5086		3801-EC	FIAT
VX 3131 AA	VA0510128	14711-KPF-9000-RW1			3952-AN	HONDA
VX 3132 AA	VE0510129	14721-KPF-9000-RW1			3953-EBN	HONDA
VX 3176 AA	VA0140226	93333561			4054-AC	GENERAL MOTORS
VX 3177 AA	VE0140248	93333562			4055-EC	GENERAL MOTORS
VX 3204 AA	VA0510227	14711-KSS-9000			4066-A	HONDA
VX 3207 AA	VA0510195	14711-KGA-B000-R			3838-AN	HONDA
VX 3208 AA	VE0510196	14721-KGA-B000-R			3839-EN	HONDA
VX 3242 AA	VE0510228	14721-KSS-9000			4067-ECB	HONDA
VX 3273 AA	VA0510197	14711-KRM-8400			3904-AC	HONDA
VX 3274 AA	VE0510198	17421-KRM-8400			3905-ECB	HONDA
VX 3285 AA	VA0520199	5HH-12111-00			3950-AN	YAMAHA
VX 3286 AA	VE0520200	5HH-12121-00			3951-ESN	YAMAHA
VX 4000 AA	VA0250160	7735898			3600-AC	FIAT
VX 4001 AA	VE0250161	7735899			3601 ECBS / 3601-ECB	FIAT
VX 4002 AA	VA0250168	60811153 / 7766564			3736-AC	ALFA ROMEO
VX 4002 AA	VA0250168	60811153 / 7766564			3736-AC	FIAT
VX 4003 AA	VE0250169	60811154 / 7766565			3737-ECBS / 3737-ECB	ALFA ROMEO
VX 4003 AA	VE0250169	60811154 / 7766565			3737-ECBS / 3737-ECB	FIAT
VX 4004 AA	VA0250165			50.017.869	3514-AC	FIAT
VX 4005 AA	VE0250164				3515-EC	FIAT
VX 4006 AA	VA0590179	97MM6507BB2B		50.017.870	3064-AC / 3090-AC	FORD
VX 4009 AA	VA0590172	89BM-6507AA			3054-AC	FORD
VX 4010 AA	VE0590173	97BM-6505-AA			3053-ECB	FORD
VX 4011 AA	VA0010211	7301820			3510-ACB / 3624-AC	IVECO
VX 4011 AA	VA0010211	7301820			3510-ACB / 3624-AC	PEUGEOT
VX 4014 AA	VE0010212	99432837EC54-0652			4041-ECB / 3587-ECB / 3625-EC	IVECO
VX 4014 AA	VE0010212	99432837EC54-0652			4041-ECB / 3587-ECB / 3625-EC	PEUGEOT
VX 4017 AA	VA0710203	1547492	VS-5143	50.017.689	3914-ACB / 4092-ACB	VOLVO
VX 4018 AA	VE0710201	8148574 / 20441945	VS-4968	50.017.667	3915-ECB	VOLVO

EATON	MAHLE	ORIGINAL	TRW	KS	3B	LINHA MOTORA
VS-0016	VA0230119	800558	VX 0023 AA	50.017.759	3272-A	FORD WILLYS
VS-0040	VA0140106	3695455 / 3758810	VX 0013 AA	50.017.700	135-A	GENERAL MOTORS
VS-0696	VA0110140	8H-1993				CATERPILLAR
VS-0969	VA0110143	5S-6452			573-A / 1573-ABS	CATERPILLAR
VS-0985	VE0210148	3803524				CUMMINS
VS-1128	VE0480079	3450500127 / 7005	VX 1566 AA	50.017.758	1843-ECP / 3263-ECB / 3263-ECB C/O	MERCEDES-BENZ
VS-1129	VA0480080	3450537001	VX 1565 AA	50.017.757	843-AC / 3262-AC / 3262-AC C/O	MERCEDES-BENZ
VS-1132	VA0590094	78MU-6507-A	VX 0756 AA	50.017.708	326-A	FORD
VS-1134	VA0130011	9.2260.460.0054	VX 0304 AA	50.017.717	565-AC	FORD
VS-1134	VA0130011	9.2260.460.0054	VX 0304 AA	50.017.717	565-AC	MWM
VS-1135	VE0130010	9.3080.460.0024	VX 0305 AA	50.017.199	1565-ECB / 3045-ECP / 1565-ECP	FORD
VS-1135	VE0130010	9.3080.460.0024	VX 0305 AA	50.017.199	1565-ECB / 3045-ECP / 1565-ECP	MWM
VS-1136	VA0480091	3550530001	VX 0846 AA	50.017.119	3262-AC / 843-AC / 843-AC C/O	MERCEDES-BENZ
VS-1137	VE0480090	3550530005	VX 0847 AA	50.017.120	3263-ECB / 1843-ECP / 1843-ECP C/O	MERCEDES-BENZ
VS-1157	VA0480048	3460530001	VX 0383 AA	50.017.044	229-AC / 229-AC C/O	MERCEDES-BENZ
VS-1158	VE0480047	3460530005	VX 0384 AA	50.017.056	1229-EC / 1229-ECP C/O	MERCEDES-BENZ
VS-1160	VA0570024	31431315	VX 0602 AA	50.017.792	249-AC	GENERAL MOTORS
VS-1160	VA0570024	31431315	VX 0602 AA	50.017.792	249-AC	PERKINS (MAXION)
VS-1161	VE0570023	31431851	VX 0604 AA	50.017.793	1249-ECP / 1499-ECP STD	GENERAL MOTORS
VS-1161	VE0570023	31431851	VX 0604 AA	50.017.793	1249-ECP / 1499-ECP STD	PERKINS (MAXION)
VS-1167	VE0700022	311.109.612	VX 0366 AD	50.017.738	1453-E	VOLKSWAGEN
VS-1177	VA0480004	3520530101	VX 0246 AE	50.017.042	226-AC / 226-AC C/O	MERCEDES-BENZ
VS-1178	VE0480003	3520531505	VX 0282 AB	50.017.049	1226-ECB / 1226-ECB C/O	MERCEDES-BENZ
VS-1201	VE0140105	3724778 / 3989084	VX 0219 AB - STD	50.017.721	1138-EG / 1138-E / 1138-E STD	GENERAL MOTORS
VS-1202	VA0140104	2638552 / 3774052	VX 0220 AB	50.017.701	137-A / 137-AG	GENERAL MOTORS
VS-1204	VE0590092	78MU-6505-B	VX 0757 AA	50.017.729	1326-E	FORD
VS-1205	VA0590093	59112	VX 0250 AA	50.017.749	3038-A	FORD
VS-1299	VA0140084	94621104/ 1038	VX 1550 AA	50.017.710	332-AC	GENERAL MOTORS
VS-1302	VE0140083	94621105/ 1043	VX 0365 AC	50.017.732	1332-ECP	GENERAL MOTORS
VS-1317	VE0700021	43109611	VX 0785 AB	50.017.728	1305-ECP	VOLKSWAGEN
VS-1335	VE0140107	3732758	VX 0238 AA +3	50.017.722	1138-EG+3	GENERAL MOTORS
VS-1356	VA0700078	049.109.601.F	VX 1202 AA	50.017.385	825-A	VOLKSWAGEN
VS-1357	VE0700077	049.109.611.F	VX 1203 AA	50.017.386	1825-E	VOLKSWAGEN
VS-1358	VA0700082	068.109.601.C	VX 1210 AA	50.017.016	303-AC	VOLKSWAGEN
VS-1359	VE0700081	068.109.611.C	VX 1209 AA	50.017.017	1303-ECB / 1303-EC	VOLKSWAGEN
VS-1367	VE0760058	232018 / 9639417980	VX 0616 AA	50.017.123	1374-ECSS	SCANIA
VS-1406	VE0110144	8N-0875			1573-EBS	CATERPILLAR
VS-1415	VA0140114	90136614/ 6613	VX 1220 AA	50.017.713	344-AC / 3108-AC	GENERAL MOTORS
VS-1423	VA0570111	31431723 / 70910011	VX 0440 AA	50.017.739	1498-ACP / 1498-ACP C/O	FORD
VS-1423	VA0570111	31431723 / 70910011	VX 0440 AA	50.017.739	1498-ACP / 1498-ACP C/O	PERKINS (MAXION)
VS-1424	VE0570112	70910012	VX 0441 AA	50.017.740	1498-ECP / 1498-ECP C/O	FORD
VS-1424	VE0570112	70910012	VX 0441 AA	50.017.740	1498-ECP / 1498-ECP C/O	PERKINS (MAXION)
VS-1481	VE0140109	7323108 / 3995603	VX 0239 AA +15	50.017.723	1138-EG+15	GENERAL MOTORS
VS-1492	VA0590044	84AU-6507-B / 0291096011	VX 1321 AA	50.017.797	814-AC / 816-AC	FORD
VS-1492	VA0590044	84AU-6507-B / 0291096011	VX 1321 AA	50.017.797	814-AC / 816-AC	VOLKSWAGEN
VS-1646	VA0700017	035.109.601.C	VX 1368 AA	50.017.396	815-AC	VOLKSWAGEN
VS-1658	VE0140113	90136620/ 6621	VX 1221 AA / VX 2034 AA	50.017.736	1344-ECP / 23108-ECPS	GENERAL MOTORS
VS-1660	VA0140041	52285384	VX 2034 AA	50.017.753	3045-ECP / 3110-AC	GENERAL MOTORS

EATON	MAHLE	ORIGINAL	TRW	KS	3B	LINHA MOTORA
VS-1696	VE0700016	035.109.611.F	VX 1472 AA	50.017.397	1815-EB / 1815-EGX	FORD
VS-1696	VE0700016	035.109.611.F	VX 1472 AA	50.017.397	1815-EB / 1815-EGX	VOLKSWAGEN
VS-1754	VA0570033	0910030 / 0910069	VX 0090 AA	50.017.707	250-AMF / 250-A	FORD
VS-1754	VA0570033	0910030 / 0910069	VX 0090 AA	50.017.707	250-AMF / 250-A	PERKINS (MAXION)
VS-1814	VA0480006	3760530101	VX 2388 AA	50.017.391	3260-ACB / 3260-ACB 20 C/O / 2026-AC 30 C/O	MERCEDES-BENZ
VS-1980	VA0140040	90220119	VX 1699 AA	50.017.752	3109-AC / 4056-AC	GENERAL MOTORS
VS-1984	VE0140039	90323756	VX 2059 AA	50.017.791	23109-ECP / 23109-EC / 4031-EPN / 4057-EX	GENERAL MOTORS
VS-2091	VE0480097	3760500027 / 3660500027	VX 2391 AA (VA1751A)	50.017.055	23260-ECB / 21226-ECB / 23260 ECB+0,4	MERCEDES-BENZ
VS-2401	VA0110145	6N-9915			3210-A	CATERPILLAR
VS-2402	VE0110146	6N-9916/ 1487455			23210-EBS	CATERPILLAR
VS-2465	VE0590042	84AU-6505-A	VX 1319 AA	50.017.748	3037-EP	FORD
VS-2489	VA0590043	84AU-6507-A	VX 1320 AA	50.017.747	3036-A	FORD
VS-2520	VA0480056	4220500226 / 4420500526	VX 2387 AA	50.017.046	1839-ACB / 1839-ACB C/O	MERCEDES-BENZ
VS-2535	VE0480005	3660500227	VX 2389 AA	50.017.390	23260-ECB / 23260-ECB C/O / 21226-ECB C/O	MERCEDES-BENZ
VS-2556	VA0250060	4239917 / 4460697	VX 2220 AA	50.017.714	175-AC / 383-AC	FIAT
VS-2557	VE0250059	5973129	VX 2221 AA	50.017.737	1383-EC	FIAT
VS-2574	VE0590065	026 109 611 A	VX 1813 AA	50.017.827	23238-EB	FORD
VS-2574	VE0590065	026 109 611 A	VX 1813 AA	50.017.827	23238-EB	VOLKSWAGEN
VS-2587	VA0480096	3760530001	VX 2390 AA (VA1648A)	50.017.389	2026-AC 30°	MERCEDES-BENZ
VS-2639	VA0590067	026109601D	VX 1947 AA		3602-A	FORD
VS-2639	VA0590067	026109601D	VX 1947 AA		3602-A	VOLKSWAGEN
VS-2691	VE0250053	5973128	VX 2400 AA	50.017.787	1175-ECSS	FIAT
VS-2692	VA0250054	7617500	VX 2399 AA	50.017.720	856-AC / 855-AC	FIAT
VS-2695	VE0130098	9.229.0.460.003.4	VX 1975 AA	50.017.768	3391-ECB	MWM
VS-2696	VA0130099	622804603014	VX 0692 AA	50.017.767	3390-AC	MWM
VS-2770	VA0480007	366.050.1226	VX 2811 AA	50.017.794	3260-ACB-20° / 3260-ACB C/O	MERCEDES-BENZ
VS-2815	VA0570038	70910017	VX 1912 AA	50.017.769	3392-AC / 249-AC C/O	GENERAL MOTORS
VS-2815	VA0570038	70910017	VX 1912 AA	50.017.769	3392-AC / 249-AC C/O	PERKINS (MAXION)
VS-2816	VE0570037	70910018	VX 1913 AA	50.017.770	3393-ECB / 1249-ECP C/O	GENERAL MOTORS
VS-2816	VE0570037	70910018	VX 1913 AA	50.017.770	3393-ECB / 1249-ECP C/O	PERKINS (MAXION)
VS-2824	VE0130100	9.610.0.460.002.4	VX 2124 AA	50.017.844	23423-ECBS / 23423-ECB	MWM
VS-2824	VE0130100	9.610.0.460.002.4	VX 2124 AA	50.017.844	23423-ECBS / 23423-ECB	VOLKSWAGEN
VS-2825	VA0130101	9.610.0.460.003.4	VX 2123 AA	50.017.844	3422-AC	MWM
VS-2825	VA0130101	9.610.0.460.003.4	VX 2123 AA	50.017.844	3422-AC	VOLKSWAGEN
VS-2831	VA0570123	70910025/ 35	VX 2299 AA	50.017.894	3342-AC	GENERAL MOTORS
VS-2831	VA0570123	70910025/ 35	VX 2299 AA	50.017.894	3342-AC	PERKINS (MAXION)
VS-2833	VE0570122	70910038	VX 2298 AA	50.017.766	3389-ECB	GENERAL MOTORS
VS-2833	VE0570122	70910038	VX 2298 AA	50.017.766	3389-ECB	PERKINS (MAXION)
VS-2873	VA0250159	7547400	VX 2047 AB	50.017.745	1826-AC	FIAT
VS-2874	VE0250158	7597080	VX 2392 AA	50.017.746	1826-ECB	FIAT
VS-3124	VA0110232	7W-8064			3614-AC	CATERPILLAR
VS-3124	VA0110232	7W-8064			3614-AC	GENERAL MOTORS
VS-3140	VE0110233	136-0819			3615-EC	CATERPILLAR
VS-3140	VE0110233	136-0819			3615-EC	GENERAL MOTORS
VS-4261	VA0140015	90323518 / 642763	VX 2332 AA	50.017.754	3136-AC / 4004-AC	GENERAL MOTORS
VS-4262	VE0140014	90.323.523 / 642890	VX 2333 AA	50.017.755	3137-ECB / 4005-EC / 3137-E	GENERAL MOTORS
VS-4306	VE0210150	3920868 / 3802356			3467-ECB / 3467-ECB C/O	CUMMINS
VS-4306	VE0210150	3920868 / 3802356			3467-ECB / 3467-ECB C/O	FORD
VS-4306	VE0210150	3920868 / 3802356			3467-ECB / 3467-ECB C/O	VOLKSWAGEN
VS-4307	VA0210151	3920867 / 3802355			3466-AC / 3466-AC C/O	CUMMINS
VS-4307	VA0210151	3920867 / 3802356			3466-AC / 3466-AC C/O	FORD
VS-4307	VA0210151	3920867 / 3802356			3466-AC / 3466-AC C/O	VOLKSWAGEN

EATON	MAHLE	ORIGINAL	TRW	KS	3B	LINHA MOTORA
VS-4308	VE0210152	3921444 / 3802085			3335-ECP	CUMMINS
VS-4308	VE0210152	3921444 / 3902254			3335-ECP	FORD
VS-4308	VE0210152	3921444 / 3802085			3335-ECP	VOLKSWAGEN
VS-4309	VA0210153	3924492 / 3802463			3334-AC	CUMMINS
VS-4309	VA0210153	3924492 / 3902253			3334-AC	FORD
VS-4309	VA0210153	3924492 / 3802463			3334-AC	VOLKSWAGEN
VS-4362	VE0480055	4220500127 / 4420500227	VX 2600 AA		1839-ECB / 1839-ECD / 1839- ECB C/O	MERCEDES-BENZ
VS-4510	VA0700088	048.109.601.E	VX 2923 AA	50.004.599	3484-AB / 815-A / 3484-A / 3486-A / 3238-A / 3310-A	VOLKSWAGEN
VS-4511	VE0700087	048.109.611.C	VX 2976 AA	50.004.601	3485-EBS / 1815-E / 3485-EB	VOLKSWAGEN
VS-4530	VA0250052	7722907	VX 2607 AA	50.017.761	3320-AC	FIAT
VS-4531	VE0250051	7574742	VX 2608 AA	50.017.762	3321-ECB	FIAT
VS-4546	VA0700089	078.109.601.B	VX 2975 AA	50.004.600	1718-A / 3486-A / 3313-A	VOLKSWAGEN
VS-457	VE0570034	0910041 / 0910073	VX 0087 AA	50.017.727	1251-EPMF / 251-E	FORD
VS-457	VE0570034	0910041 / 0910073	VX 0087 AA	50.017.727	1251-EPMF / 251-E	PERKINS (MAXION)
VS-460	VE0110141	8H-1994				CATERPILLAR
VS-4762	VA0590066	035109601G	VX 1812 AB	50.017.826	3312-A	FORD
VS-4762	VA0590066	035109601G	VX 1812 AB	50.017.826	3312-A	VOLKSWAGEN
VS-4856	VE0700027	030.109.611.AC	VX 2931 AA	50.017.853	3513-EB	VOLKSWAGEN
VS-4892	VE0570230	70910054		50.017.847	23345-ECB / 23345-ECBS	FORD
VS-4892	VE0570230	70910054		50.017.847	23345-ECB / 23345-ECBS	GENERAL MOTORS
VS-4892	VE0570230	6010532827		50.017.847	23345-ECB / 23345-ECBS	MERCEDES-BENZ
VS-4892	VE0570230	70910076		50.017.847	23345-ECB / 23345-ECBS	PERKINS (MAXION)
VS-4893	VA0700252	032.109.601.M	VX 3066 AA	50.017.846	3886-A	VOLKSWAGEN
VS-4897	VA0250018	46470637 / 46559031	VX 2028 AA	50.017.756	3234-AC	FIAT
VS-4898	VE0250019	7633752 / 46470638	VX 2029 AA			FIAT
VS-4899	VA0140086	7083246 / 90215492	VX 2331 AA	50.017.835	3146-AC / 3912-AC	FIAT
VS-4899	VA0140086	90215492 / 7083246	VX 2331 AA	50.017.835	3146-AC / 3912-AC	GENERAL MOTORS
VS-4900	VE0140085	90324412	VX 2334 AA	50.017.836	3147-ECB	GENERAL MOTORS
VS-4901	VA0140076	90412712	VX 2463 AA	50.017.837	3138-AC	GENERAL MOTORS
VS-4905	VA0760013	352211 / 352212 / 294674 / 289483	VX 1784 AA	50.017.789	1374-ACB 20° / 23394- ACBS / 23394-ACB	SCANIA
VS-4906	VA0510045	14711-383-000	VX 0786 AA	50.017.778	23293-AP	HONDA
VS-4917	VA0510116	14711-397-6300	VX 1473 AA	50.017.772	3408-AC	HONDA
VS-4918	VE0510046	14721-383-000	VX 0787 AA	50.017.779	23293-EP	HONDA
VS-4919	VA0700028	030.109.601.AC	VX 2930 AA	50.017.849	3512-A	VOLKSWAGEN
VS-4934	VA0710063	469240 / 4675002 / 8194223	VX 0588 AB	50.017.126	860-AC / 860-AC C/O	VOLVO
VS-4936	VE0710064	467855 / 8194224	VX 1085 AB	50.017.127	1861-ECP / 1861-ECB C/O	VOLVO
VS-4937	VA0710121	468302	VX 1594 AA	50.017.124	582-AC	VOLVO
VS-4938	VE0710120	468303	VX 1455 AC	50.017.125	1582-ECP	VOLVO
VS-4939	VA0590174		V74469A0		3092-AC	FORD
VS-4968	VE0710201	8148574 / 20441945	VX 4018 AA	50.017.667	3915-ECB	VOLVO
VS-4985	VA0510115	14711-440-0030-BR	VX 0989 AA		3408-AC	HONDA
VS-4993	VA0510029	14711-KYO-8901-R	VX 2324 AA	50.017.774	3416-AC	HONDA
VS-4994	VE0510030	14721-KYO-8901-R	VX 2325 AA	50.017.783	23417-ECBS / 23417-ECB	HONDA
VS-4995	VA0510070	14711-KW1-9000-R	VX 2009 AA	50.017.785	1001-AC	HONDA
VS-4996	VE0510069	14721-KW1-9000-R	VX 2018 AA	50.017.786	1002-ECB	HONDA
VS-4997	VE0510117	14721-437-0000	VX 0990 AA	50.017.781	23409-ECSS / 23409-ECB	HONDA
VS-5000	VA0510130	14711-428-000		50.017.771	3406-AN	HONDA
VS-5001	VE0510131	14721-471-000		50.017.780	23407-ECSS / 23407-EBN	HONDA
VS-5002	VA0510132	14711-KGO-000		50.017.773	3410-ANS / 3410-AN	HONDA
VS-5003	VE0510133	14721-KGO-000		50.017.782	23411-ECSS / 23411-EBN	HONDA
VS-5004	VA0510134	14711-KL3-670		50.017.843	3418-ACS	HONDA
VS-5005	VE0510135	14721-KFO-000		50.017.784	23419-ECSS	HONDA
VS-5006	VA0510191	14711-413-000		50.017.743	1647-AB	HONDA
VS-5007	VE0510192	14721-413-000		50.017.744	1647-EB	HONDA

EATON	MAHLE	ORIGINAL	TRW	KS	3B	LINHA MOTORA
VS-5037	VA0480193	5410500226			3856-AC / 4096-AC	MERCEDES-BENZ
VS-5085	VA0250166	46553048			3558-AC / 3998-AC	FIAT
VS-5086	VE0250167	46553047	VX 3129 AA		3801-EC	FIAT
VS-5086	VE0140071	90410813 / 641325	VX 2274 AA	50.004.484	23141-ECBS / 23141-EC / 3775-ECBS	GENERAL MOTORS
VS-5087	VA0250162	46553046	VX 3128 AA		3800-AC	FIAT
VS-5088	VE0250163	46553049			3559-ECBS / 3559-EC / 3999-ECB	FIAT
VS-5094	VA0140072	90412277 / 641022	VX 2909 AA	50.004.483	3140-AC / 3774-AC	GENERAL MOTORS
VS-5102	VA0210442	3940735			3976-AC	CUMMINS
VS-5127	VE0590175	XS6E6505BB / YS4E.6505.BA	V74470A0		3093-ECBS / 3093-EC	FORD
VS-5127	VA0700009	036.109.601.R	VX 2875 AA	50.017.860	3508-A	VOLKSWAGEN
VS-5143	VA0710203	1547492	VX 4017 AA	50.017.689	3914-ACB / 4092-ACB	VOLVO
VS-5166	VE0760012	1100997 / 1360834 / 232018	VX 2019 AA	50.017.790	1374-ECSS / 23395-ECSS / 23395-ECS	SCANIA
VS-5223	VE0700008	036.109.611.J	VX 2989 AA	50.017.861	3509-EB / 3509-E	VOLKSWAGEN
VS-5225	VE0480194	5410500227	VX 2951 AB		3857-ECB	MERCEDES-BENZ
VS-5281	VA2110185	ON01-12-111		50.017.850	3548-APN / 3826-AN	KIA MOTORS
VS-5281	VA2110185	ON01-12-111		50.017.850	3548-APN / 3826-AN	MAZDA
VS-5282	VE2110186	ON01-12-121		50.017.851	3548-EBN / 3549-EBN	KIA MOTORS
VS-5282	VE2110186	ON01-12-121		50.017.851	3548-EBN / 3549-EBN	MAZDA
VS-5284	VA2110229	K710-12-111		50.017.866	3298-AN	KIA MOTORS
VS-5284	VA2110229	K710-12-111		50.017.866	3298-AN	MAZDA
VS-5294	VA0590180	928M-650-F2-A			3066-AC / 3814-AC / 3082-AC / 3068-AC	FORD
VS-5295	VE0590182	948M-6505-D2A			3067-ECB / 3069-ECB / 3067-EC / 3815-EC	FORD
VS-5296	VA2110187	OK65D12111			3828-AN	KIA MOTORS
VS-5297	VE2110188	OK63C-12-121			3827-EBN	KIA MOTORS
VS-618	VE0570036	0910002	VX 0091 AA	50.017.705	248-E / 248-E C/O	PERKINS (MAXION)
VS-620	VA0570035	31431261 / 0910001	VX 0092 AB		247-A / 247-A C/O	PERKINS (MAXION)
VS-770	VE0230118	800558	VX 0088 AA	50.017.760	3273-E / 3272-E	FORD WILLYS
VS-770	VE0230118	B-27220	VX 0088 AA	50.017.760	3273-E / 3272-E	JEEP
VS-850	VE0700049	040.109.612.2	VX 0201 AA	50.017.788	1452-E	VOLKSWAGEN
VS-865	VA0140108	2787538 / 3786360	VX 0221 AA +3	50.017.702	137-A+3 / 137 AG+3	GENERAL MOTORS
VS-866	VA0140110	3786361 / 3995685	VX 0222 AA +15	50.017.703	137-A+15 / 137 AG+15	GENERAL MOTORS
VS-868	VA0700050	040.109.601.1	VX 0435 AF	50.017.715	422-A / 452-A	VOLKSWAGEN
VS-869	VA0700020	040.109.601.2	VX 0434 AG	50.017.716	452-A / 453-A	VOLKSWAGEN
VS-886	VE0570031	70910002	VX 0257 AA	50.017.706	248-E C/P	PERKINS (MAXION)
VS-887	VA0570032	70910001/4	VX 0256 AA	50.017.704	247-A C/P	PERKINS (MAXION)
VS-968	VE0110142	5S-6449			573-E	CATERPILLAR
VS-980	VE0700062	056.109.611.A	VX 0429 AA	50.017.072	1422-EB	VOLKSWAGEN
VS-981	VA0700061	056.109.601.A	VX 0428 AF	50.017.392	422-AC / 422-A	VOLKSWAGEN
VS-985	VE0210149	3803519			1420-EB / 1420-EBS	CUMMINS
VS-992	VA0250002	43401180	VX 0514 AB	50.017.170	380-AC	FIAT
VS-993	VE0250001	59852970	VX 1628 AA	50.017.171	1380-EC	FIAT

KS	MAHLE	ORIGINAL	TRW	EATON	3B	LINHA MOTORA
50.004.483	VA0140072	90412277 / 641022	VX 2909 AA	VS-5094	3140-AC / 3774-AC	GENERAL MOTORS
50.004.484	VE0140071	90410813 / 641325	VX 2274 AA	VS-5086	23141-ECBS / 23141-EC / 3775-ECBS	GENERAL MOTORS
50.004.507	VA0700242	058.109.601.C			3488-AS	AUDI
50.004.507	VA0700242	058.109.601.C			3488-AS	VOLKSWAGEN
50.004.508	VE0700243	058.109.611.E			3489-ECBS / 3489-EC	AUDI
50.004.508	VE0700243	058.109.611.E			3489-ECBS / 3489-EC	VOLKSWAGEN
50.004.599	VA0700088	048.109.601.E	VX 2923 AA	VS-4510	3484-AB / 815-A / 3484-A / 3486-A / 3238-A / 3310-A	VOLKSWAGEN
50.004.600	VA0700089	078.109.601.B	VX 2975 AA	VS-4546	1718-A / 3486-A / 3313-A	VOLKSWAGEN
50.004.601	VE0700087	048.109.611.C	VX 2976 AA	VS-4511	3485-EBS / 1815-E / 3485-EB	VOLKSWAGEN
50.009.016	VA0760103	1515743 / 1333230	VX 2750 AA		3662-ACB / 3663-ECBS / 4242-AX	SCANIA
50.017.016	VA0700082	068.109.601.C	VX 1210 AA	VS-1358	303-AC	VOLKSWAGEN
50.017.017	VE0700081	068.109.611.C	VX 1209 AA	VS-1359	1303-ECB / 1303-EC	VOLKSWAGEN
50.017.042	VA0480004	3520530101	VX 0246 AE	VS-1177	226-AC / 226-AC C/O	MERCEDES-BENZ
50.017.044	VA0480048	3460530001	VX 0383 AA	VS-1157	229-AC / 229-AC C/O	MERCEDES-BENZ
50.017.046	VA0480056	4220500226 / 4420500526	VX 2387 AA	VS-2520	1839-ACB / 1839-ACB C/O	MERCEDES-BENZ
50.017.049	VE0480003	3520531505	VX 0282 AB	VS-1178	1226-ECB / 1226-ECB C/O	MERCEDES-BENZ
50.017.055	VE0480097	3760500027 / 3660500027	VX 2391 AA (VA1751A)	VS-2091	23260-ECB / 21226-ECB / 23260-ECB+0,4	MERCEDES-BENZ
50.017.056	VE0480047	3460530005	VX 0384 AA	VS-1158	1229-EC / 1229-ECP C/O	MERCEDES-BENZ
50.017.072	VE0700062	056.109.611.A	VX 0429 AA	VS-980	1422-EB	VOLKSWAGEN
50.017.086	VE0761424	1854801				SCANIA
50.017.087	VA0761423	1887056				SCANIA
50.017.119	VA0480091	3550530001	VX 0846 AA	VS-1136	3262-AC / 843-AC / 843-AC C/O	MERCEDES-BENZ
50.017.120	VE0480090	3550530005	VX 0847 AA	VS-1137	3263-ECB / 1843-ECP / 1843-ECP C/O	MERCEDES-BENZ
50.017.123	VE0760058	232018 / 9639417980	VX 0616 AA	VS-1367	1374-ECSS	SCANIA
50.017.124	VA0710121	468302	VX 1594 AA	VS-4937	582-AC	VOLVO
50.017.125	VE0710120	468303	VX 1455 AC	VS-4938	1582-ECP	VOLVO
50.017.126	VA0710063	469240 / 4675002 / 8194223	VX 0588 AB	VS-4934	860-AC / 860-AC C/O	VOLVO
50.017.127	VE0710064	467855 / 8194224	VX 1085 AB	VS-4936	1861-ECP / 1861-ECB C/O	VOLVO
50.017.170	VA0250002	43401180	VX 0514 AB	VS-992	380-AC	FIAT
50.017.171	VE0250001	59852970	VX 1628 AA	VS-993	1380-EC	FIAT
50.017.199	VE0130010	9.3080.460.0024	VX 0305 AA	VS-1135	1565-ECB / 3045-ECP / 1565-ECP	FORD
50.017.199	VE0130010	9.3080.460.0024	VX 0305 AA	VS-1135	1565-ECB / 3045-ECP / 1565-ECP	MWM
50.017.385	VA0700078	049.109.601.F	VX 1202 AA	VS-1356	825-A	VOLKSWAGEN
50.017.386	VE0700077	049.109.611.F	VX 1203 AA	VS-1357	1825-E	VOLKSWAGEN
50.017.389	VA0480096	3760530001	VX 2390 AA (VA1648A)	VS-2587	2026-AC 30°	MERCEDES-BENZ
50.017.390	VE0480005	3660500227	VX 2389 AA	VS-2535	23260-ECB / 23260-ECB C/O / 21226-ECB C/O	MERCEDES-BENZ
50.017.391	VA0480006	3760530101	VX 2388 AA	VS-1814	3260-ACB / 3260-ACB 20 C/O / 2026-AC 30 C/O	MERCEDES-BENZ
50.017.392	VA0700061	056.109.601.A	VX 0428 AF	VS-981	422-AC / 422-A	VOLKSWAGEN
50.017.396	VA0700017	035.109.601.C	VX 1368 AA	VS-1646	815-AC	VOLKSWAGEN
50.017.397	VE0700016	035.109.611.F	VX 1472 AA	VS-1696	1815-EB / 1815-EGX	FORD
50.017.397	VE0700016	035.109.611.F	VX 1472 AA	VS-1696	1815-EB / 1815-EGX	VOLKSWAGEN
50.017.464	VA0510126	14711-GN5-9130	VX 3043 AA		1010-A	HONDA
50.017.635	VE0510210	14721-PO8000 / 14721-P2A-000			3855-EBN / 3433-EBN	HONDA
50.017.667	VE0710201	8148574 / 20441945	VX 4018 AA	VS-4968	3915-ECB	VOLVO
50.017.689	VA0710203	1547492	VX 4017 AA	VS-5143	3914-ACB / 4092-ACB	VOLVO
50.017.700	VA0140106	3695455 / 3758810	VX 0013 AA	VS-0040	135-A	GENERAL MOTORS

KS	MAHLE	ORIGINAL	TRW	EATON	3B	LINHA MOTORA
50.017.701	VA0140104	2638552 / 3774052	VX 0220 AB	VS-1202	137-A / 137-AG	GENERAL MOTORS
50.017.702	VA0140108	2787538 / 3786360	VX 0221 AA +3	VS-865	137-A+3 / 137-AG+3	GENERAL MOTORS
50.017.703	VA0140110	3786361 / 3995685	VX 0222 AA +15	VS-866	137-A+15 / 137-AG+15	GENERAL MOTORS
50.017.704	VA0570032	70910001/4	VX 0256 AA	VS-887	247-A C/P	PERKINS (MAXION)
50.017.705	VE0570036	0910002	VX 0091 AA	VS-618	248-E / 248-E C/O	PERKINS (MAXION)
50.017.706	VE0570031	70910002	VX 0257 AA	VS-886	248-E C/P	PERKINS (MAXION)
50.017.707	VA0570033	0910030 / 0910069	VX 0090 AA	VS-1754	250-AMF / 250-A	FORD
50.017.707	VA0570033	0910030 / 0910069	VX 0090 AA	VS-1754	250-AMF / 250-A	PERKINS (MAXION)
50.017.708	VA0590094	78MU-6507-A	VX 0756 AA	VS-1132	326-A	FORD
50.017.710	VA0140084	94621104/ 1038	VX 1550 AA	VS-1299	332-AC	GENERAL MOTORS
50.017.713	VA0140114	90136614/ 6613	VX 1220 AA	VS-1415	344-AC / 3108-AC	GENERAL MOTORS
50.017.714	VA0250060	4239917 / 4460697	VX 2220 AA	VS-2556	175-AC / 383-AC	FIAT
50.017.715	VA0700050	040.109.601.1	VX 0435 AF	VS-868	422-A / 452-A	VOLKSWAGEN
50.017.716	VA0700020	040.109.601.2	VX 0434 AG	VS-869	452-A / 453-A	VOLKSWAGEN
50.017.717	VA0130011	9.2260.460.0054	VX 0304 AA	VS-1134	565-AC	FORD
50.017.717	VA0130011	9.2260.460.0054	VX 0304 AA	VS-1134	565-AC	MWM
50.017.720	VA0250054	7617500	VX 2399 AA	VS-2692	856-AC / 855-AC	FIAT
50.017.721	VE0140105	3724778 / 3989084	VX 0219 AB - STD	VS-1201	1138-EG / 1138-E / 1138-E STD	GENERAL MOTORS
50.017.722	VE0140107	3732758	VX 0238 AA +3	VS-1335	1138-EG+3	GENERAL MOTORS
50.017.723	VE0140109	7323108 / 3995603	VX 0239 AA +15	VS-1481	1138-EG+15	GENERAL MOTORS
50.017.727	VE0570034	0910041 / 0910073	VX 0087 AA	VS-457	1251-EPMF / 251-E	FORD
50.017.727	VE0570034	0910041 / 0910073	VX 0087 AA	VS-457	1251-EPMF / 251-E	PERKINS (MAXION)
50.017.728	VE0700021	43109611	VX 0785 AB	VS-1317	1305-ECP	VOLKSWAGEN
50.017.729	VE0590092	78MU-6505-B	VX 0757 AA	VS-1204	1326-E	FORD
50.017.732	VE0140083	94621105/ 1043	VX 0365 AC	VS-1302	1332-ECP	GENERAL MOTORS
50.017.736	VE0140113	90136620/ 6621	VX 1221 AA / VX 2034 AA	VS-1658	1344-ECP / 23108-ECPS	GENERAL MOTORS
50.017.737	VE0250059	5973129	VX 2221 AA	VS-2557	1383-EC	FIAT
50.017.738	VE0700022	311.109.612	VX 0366 AD	VS-1167	1453-E	VOLKSWAGEN
50.017.739	VA0570111	31431723 / 70910011	VX 0440 AA	VS-1423	1498-ACP / 1498-ACP C/O	FORD
50.017.739	VA0570111	31431723 / 70910011	VX 0440 AA	VS-1423	1498-ACP / 1498-ACP C/O	PERKINS (MAXION)
50.017.740	VE0570112	70910012	VX 0441 AA	VS-1424	1498-ECP / 1498-ECP C/O	FORD
50.017.740	VE0570112	70910012	VX 0441 AA	VS-1424	1498-ECP / 1498-ECP C/O	PERKINS (MAXION)
50.017.743	VA0510191	14711-413-000		VS-5006	1647-AB	HONDA
50.017.744	VE0510192	14721-413-000		VS-5007	1647-EB	HONDA
50.017.745	VA0250159	7547400	VX 2047 AB	VS-2873	1826-AC	FIAT
50.017.746	VE0250158	7597080	VX 2392 AA	VS-2874	1826-ECB	FIAT
50.017.747	VA0590043	84AU-6507-A	VX 1320 AA	VS-2489	3036-A	FORD
50.017.748	VE0590042	84AU-6505-A	VX 1319 AA	VS-2465	3037-EP	FORD
50.017.749	VA0590093	59112	VX 0250 AA	VS-1205	3038-A	FORD
50.017.752	VA0140040	90220119	VX 1699 AA	VS-1980	3109-AC / 4056-AC	GENERAL MOTORS
50.017.753	VA0140041	52285384	VX 2034 AA	VS-1660	3045-ECP / 3110-AC	GENERAL MOTORS
50.017.754	VA0140015	90323518 / 642763	VX 2332 AA	VS-4261	3136-AC / 4004-AC	GENERAL MOTORS
50.017.755	VE0140014	90.323.523 / 642890	VX 2333 AA	VS-4262	3137-ECB / 4005-EC / 3137-E	GENERAL MOTORS
50.017.756	VA0250018	46470637 / 46559031	VX 2028 AA	VS-4897	3234-AC	FIAT
50.017.757	VA0480080	3450537001	VX 1565 AA	VS-1129	843-AC / 3262-AC / 3262-AC C/O	MERCEDES-BENZ
50.017.758	VE0480079	3450500127 / 7005	VX 1566 AA	VS-1128	1843-ECP / 3263-ECB / 3263-ECB C/O	MERCEDES-BENZ
50.017.759	VA0230119	800558	VX 0023 AA	VS-0016	3272-A	FORD WILLYS
50.017.760	VE0230118	800558	VX 0088 AA	VS-770	3273-E / 3272-E	FORD WILLYS
50.017.760	VE0230118	B-27220	VX 0088 AA	VS-770	3273-E / 3272-E	JEEP
50.017.761	VA0250052	7722907	VX 2607 AA	VS-4530	3320-AC	FIAT
50.017.762	VE0250051	7574742	VX 2608 AA	VS-4531	3321-ECB	FIAT
50.017.766	VE0570122	70910038	VX 2298 AA	VS-2833	3389-ECB	GENERAL MOTORS

KS	MAHLE	ORIGINAL	TRW	EATON	3B	LINHA MOTORA
50.017.766	VE0570122	70910038	VX 2298 AA	VS-2833	3389-ECB	PERKINS (MAXION)
50.017.767	VA0130099	622804603014	VX 0692 AA	VS-2696	3390-AC	MWM
50.017.768	VE0130098	9.229.0.460.003.4	VX 1975 AA	VS-2695	3391-ECB	MWM
50.017.769	VA0570038	70910017	VX 1912 AA	VS-2815	3392-AC / 249-AC C/O	GENERAL MOTORS
50.017.769	VA0570038	70910017	VX 1912 AA	VS-2815	3392-AC / 249-AC C/O	PERKINS (MAXION)
50.017.770	VE0570037	70910018	VX 1913 AA	VS-2816	3393-ECB / 1249-ECP C/O	GENERAL MOTORS
50.017.770	VE0570037	70910018	VX 1913 AA	VS-2816	3393-ECB / 1249-ECP C/O	PERKINS (MAXION)
50.017.771	VA0510130	14711-428-000		VS-5000	3406-AN	HONDA
50.017.772	VA0510116	14711-397-6300	VX 1473 AA	VS-4917	3408-AC	HONDA
50.017.773	VA0510132	14711-KGO-000		VS-5002	3410-ANS / 3410-AN	HONDA
50.017.774	VA0510029	14711-KYO-8901-R	VX 2324 AA	VS-4993	3416-AC	HONDA
50.017.778	VA0510045	14711-383-000	VX 0786 AA	VS-4906	23293-AP	HONDA
50.017.779	VE0510046	14721-383-000	VX 0787 AA	VS-4918	23293-EP	HONDA
50.017.780	VE0510131	14721-471-000		VS-5001	23407-ECSS / 23407-EBN	HONDA
50.017.781	VE0510117	14721-437-0000	VX 0990 AA	VS-4997	23409-ECSS / 23409-ECB	HONDA
50.017.782	VE0510133	14721-KGO-000		VS-5003	23411-ECSS / 23411-EBN	HONDA
50.017.783	VE0510030	14721-KYO-8901-R	VX 2325 AA	VS-4994	23417-ECBS / 23417-ECB	HONDA
50.017.784	VE0510135	14721-KFO-000		VS-5005	23419-ECSS	HONDA
50.017.785	VA0510070	14711-KW1-9000-R	VX 2009 AA	VS-4995	1001-AC	HONDA
50.017.786	VE0510069	14721-KW1-9000-R	VX 2018 AA	VS-4996	1002-ECB	HONDA
50.017.787	VE0250053	5973128	VX 2400 AA	VS-2691	1175-ECSS	FIAT
50.017.788	VE0700049	040.109.612.2	VX 0201 AA	VS-850	1452-E	VOLKSWAGEN
50.017.789	VA0760013	352211 / 352212 / 294674 / 289483	VX 1784 AA	VS-4905	1374-ACB 20° / 23394- ACBS / 23394-ACB	SCANIA
50.017.790	VE0760012	1100997 / 1360834 / 232018	VX 2019 AA	VS-5166	1374-ECSS / 23395-ECSS / 23395-ECS	SCANIA
50.017.791	VE0140039	90323756	VX 2059 AA	VS-1984	23109-ECP / 23109-EC / 4031-EPN / 4057-EX	GENERAL MOTORS
50.017.792	VA0570024	31431315	VX 0602 AA	VS-1160	249-AC	GENERAL MOTORS
50.017.792	VA0570024	31431315	VX 0602 AA	VS-1160	249-AC	PERKINS (MAXION)
50.017.793	VE0570023	31431851	VX 0604 AA	VS-1161	1249-ECP / 1499-ECP STD	GENERAL MOTORS
50.017.793	VE0570023	31431851	VX 0604 AA	VS-1161	1249-ECP / 1499-ECP STD	PERKINS (MAXION)
50.017.794	VA0480007	366.050.1226	VX 2811 AA	VS-2770	3260-ACB-20° / 3260-ACB C/O	MERCEDES-BENZ
50.017.797	VA0590044	84AU-6507-B / 0291096011	VX 1321 AA	VS-1492	814-AC / 816-AC	FORD
50.017.797	VA0590044	84AU-6507-B / 0291096011	VX 1321 AA	VS-1492	814-AC / 816-AC	VOLKSWAGEN
50.017.801	VE0590178	X56G6505B2A			3065-EN / 3091-ECB	FORD
50.017.826	VA0590066	035109601G	VX 1812 AB	VS-4762	3312-A	FORD
50.017.826	VA0590066	035109601G	VX 1812 AB	VS-4762	3312-A	VOLKSWAGEN
50.017.827	VE0590065	026 109 611 A	VX 1813 AA	VS-2574	23238-EB	FORD
50.017.827	VE0590065	026 109 611 A	VX 1813 AA	VS-2574	23238-EB	VOLKSWAGEN
50.017.835	VA0140086	7083246 / 90215492	VX 2331 AA	VS-4899	3146-AC / 3912-AC	FIAT
50.017.835	VA0140086	90215492 / 7083246	VX 2331 AA	VS-4899	3146-AC / 3912-AC	GENERAL MOTORS
50.017.836	VE0140085	90324412	VX 2334 AA	VS-4900	3147-ECB	GENERAL MOTORS
50.017.837	VA0140076	90412712	VX 2463 AA	VS-4901	3138-AC	GENERAL MOTORS
50.017.838	VE0140075	90412974	VX 2925 AA		3139-EC	GENERAL MOTORS
50.017.843	VA0510134	14711-KL3-670		VS-5004	3418-ACS	HONDA
50.017.844	VA0130101	9.610.0.460.003.4	VX 2123 AA	VS-2825	3422-AC	MWM
50.017.844	VE0130100	9.610.0.460.002.4	VX 2124 AA	VS-2824	23423-ECBS / 23423-ECB	MWM
50.017.844	VA0130101	9.610.0.460.003.4	VX 2123 AA	VS-2825	3422-AC	VOLKSWAGEN
50.017.844	VE0130100	9.610.0.460.002.4	VX 2124 AA	VS-2824	23423-ECBS / 23423-ECB	VOLKSWAGEN
50.017.846	VA0700252	032.109.601.M	VX 3066 AA	VS-4893	3886-A	VOLKSWAGEN
50.017.847	VE0570230	70910054		VS-4892	23345-ECB / 23345-ECBS	FORD
50.017.847	VE0570230	70910054		VS-4892	23345-ECB / 23345-ECBS	GENERAL MOTORS
50.017.847	VE0570230	6010532827		VS-4892	23345-ECB / 23345-ECBS	MERCEDES-BENZ
50.017.847	VE0570230	70910076		VS-4892	23345-ECB / 23345-ECBS	PERKINS (MAXION)

KS	MAHLE	ORIGINAL	TRW	EATON	3B	LINHA MOTORA
50.017.849	VA0700028	030.109.601.AC	VX 2930 AA	VS-4919	3512-A	VOLKSWAGEN
50.017.850	VA2110185	ON01-12-111		VS-5281	3548-APN / 3826-AN	KIA MOTORS
50.017.850	VA2110185	ON01-12-111		VS-5281	3548-APN / 3826-AN	MAZDA
50.017.851	VE2110186	ON01-12-121		VS-5282	3548-EBN / 3549-EBN	KIA MOTORS
50.017.851	VE2110186	ON01-12-121		VS-5282	3548-EBN / 3549-EBN	MAZDA
50.017.853	VE0700027	030.109.611.AC	VX 2931 AA	VS-4856	3513-EB	VOLKSWAGEN
50.017.854	VA0590181	89BM-6507AA	V76175A0		3052-AC	FORD
50.017.857	VA0720154				3296-AN	ASIA MOTORS
50.017.858	VE0720155				3297-EBN	ASIA MOTORS
50.017.860	VA0700009	036.109.601.R	VX 2875 AA	VS-5127	3508-A	VOLKSWAGEN
50.017.861	VE0700008	036.109.611.J	VX 2989 AA	VS-5223	3509-EB / 3509-E	VOLKSWAGEN
50.017.866	VA2110229	K710-12-111		VS-5284	3298-AN	KIA MOTORS
50.017.866	VA2110229	K710-12-111		VS-5284	3298-AN	MAZDA
50.017.869	VA0250165		VX 4004 AA		3514-AC	FIAT
50.017.870	VA0590179	97MM6507BB2B	VX 4006 AA		3064-AC / 3090-AC	FORD
50.017.894	VA0570123	70910025/ 35	VX 2299 AA	VS-2831	3342-AC	GENERAL MOTORS
50.017.894	VA0570123	70910025/ 35	VX 2299 AA	VS-2831	3342-AC	PERKINS (MAXION)
50.017.897	VA0011469	500355778			4094-AC	IVECO
50.017.898	VE0011470	504293892			4095-ECB	IVECO
50.017.926	VA0510263	14711-PWA-000			4164-AN	HONDA
50.017.927	VE0510264	14721-PWA-000			4165-EN	HONDA
50.017.928	VA0510265	14711-PWC-000				HONDA
50.017.929	VE0510266	14721-PWC-000				HONDA
50.017.930	VA0510257	14711-RNA-A00				HONDA
50.017.935	VA0180393	8200708663			3526-A / 4184-AN	RENAULT
50.017.936	VE0180310	8200708662			3527-E / 4185-EN	RENAULT
50.017.972	VE0251476	55218807			4257-EC	FIAT

3B	MAHLE	ORIGINAL	TRW	EATON	KS	LINHA MOTORA
1001-AC	VA0510070	14711-KW1-9000-R	VX 2009 AA	VS-4995	50.017.785	HONDA
1002-ECB	VE0510069	14721-KW1-9000-R	VX 2018 AA	VS-4996	50.017.786	HONDA
1010-A	VA0510126	14711-GN5-9130	VX 3043 AA		50.017.464	HONDA
1011-ESN	VE0510127	14721-GF6-0101	VX 3042 AA			HONDA
1138-E	VE0140105	3724778 / 3989084	VX 0219 AB - STD	VS-1201	50.017.721	GENERAL MOTORS
1138-E STD	VE0140105	3724778 / 3989084	VX 0219 AB - STD	VS-1201	50.017.721	GENERAL MOTORS
1138-EG	VE0140105	3724778 / 3989084	VX 0219 AB - STD	VS-1201	50.017.721	GENERAL MOTORS
1138-EG+15	VE0140109	7323108 / 3995603	VX 0239 AA +15	VS-1481	50.017.723	GENERAL MOTORS
1138-EG+3	VE0140107	3732758	VX 0238 AA +3	VS-1335	50.017.722	GENERAL MOTORS
1175-ECSS	VE0250053	5973128	VX 2400 AA	VS-2691	50.017.787	FIAT
1226-ECB	VE0480003	3520531505	VX 0282 AB	VS-1178	50.017.049	MERCEDES-BENZ
1226-ECB C/O	VE0480003	3520531505	VX 0282 AB	VS-1178	50.017.049	MERCEDES-BENZ
1229-EC	VE0480047	3460530005	VX 0384 AA	VS-1158	50.017.056	MERCEDES-BENZ
1229-EC+0.4	VE0480047+04					MERCEDES-BENZ
1229-EC+0.8	VE0480047+08					MERCEDES-BENZ
1229-ECP C/O	VE0480047	3460530005	VX 0384 AA	VS-1158	50.017.056	MERCEDES-BENZ
1246-EC	VE0440583	7581717000				PEUGEOT
1246-EC+0,4	VE0440583+04					PEUGEOT
1246-EC+0,8	VE0440583+08					PEUGEOT
1249-ECP	VE0570023	31431851	VX 0604 AA	VS-1161	50.017.793	GENERAL MOTORS
1249-ECP	VE0570023	31431851	VX 0604 AA	VS-1161	50.017.793	PERKINS (MAXION)
1249-ECP C/O	VE0570037	70910018	VX 1913 AA	VS-2816	50.017.770	GENERAL MOTORS
1249-ECP C/O	VE0570037	70910018	VX 1913 AA	VS-2816	50.017.770	PERKINS (MAXION)
1251-EPMF	VE0570034	0910041 / 0910073	VX 0087 AA	VS-457	50.017.727	FORD
1251-EPMF	VE0570034	0910041 / 0910073	VX 0087 AA	VS-457	50.017.727	PERKINS (MAXION)
1303-EC	VE0700081	068.109.611.C	VX 1209 AA	VS-1359	50.017.017	VOLKSWAGEN
1303-ECB	VE0700081	068.109.611.C	VX 1209 AA	VS-1359	50.017.017	VOLKSWAGEN
1305-ECP	VE0700021	43109611	VX 0785 AB	VS-1317	50.017.728	VOLKSWAGEN
1326-E	VE0590092	78MU-6505-B	VX 0757 AA	VS-1204	50.017.729	FORD
1330-ECP	VE0140184	12550909				GENERAL MOTORS
1332-ECP	VE0140083	94621105/ 1043	VX 0365 AC	VS-1302	50.017.732	GENERAL MOTORS
1332-ECP+06	VE0140083 0,152	94621047				GENERAL MOTORS
1332-ECP+10	VE0140083 0,254					GENERAL MOTORS
1332-ECP+12	VE0140083 0,304	94621609				GENERAL MOTORS
1332-ECP+15	VE0140083 0,381					GENERAL MOTORS
1332-ECP+20	VE0140083 0,508					GENERAL MOTORS
1332-ECP+3	VE0140083 0,076	94621045				GENERAL MOTORS
1332-ECP+30	VE0140083 0,762					GENERAL MOTORS
1332-ECP+5	VE0140083 0,127					GENERAL MOTORS
1344-ECP	VE0140113	90136620/ 6621	VX 1221 AA / VX 2034 AA	VS-1658	50.017.736	GENERAL MOTORS
1344-ECP+15	VE0140113 0,381					GENERAL MOTORS
1344-ECP+3	VE0140113 0,076	90136622				GENERAL MOTORS
1344-ECP+30	VE0140113 0,762	90136624				GENERAL MOTORS
135-A	VA0140106	3695455 / 3758810	VX 0013 AA	VS-0040	50.017.700	GENERAL MOTORS
1363-ECP	VE0180305					RENAULT
1374-ACB 20°	VA0760013	352211 / 352212 / 294674 / 289483	VX 1784 AA	VS-4905	50.017.789	SCANIA
1374-ECSS	VE0760012	1100997 / 1360834 / 232018	VX 2019 AA	VS-5166	50.017.790	SCANIA
1374-ECSS	VE0760058	232018 / 9639417980	VX 0616 AA	VS-1367	50.017.123	SCANIA
137-A	VA0140104	2638552 / 3774052	VX 0220 AB	VS-1202	50.017.701	GENERAL MOTORS
137-A+15	VA0140110	3786361 / 3995685	VX 0222 AA +15	VS-866	50.017.703	GENERAL MOTORS
137-A+3	VA0140108	2787538 / 3786360	VX 0221 AA +3	VS-865	50.017.702	GENERAL MOTORS
137-AG	VA0140104	2638552 / 3774052	VX 0220 AB	VS-1202	50.017.701	GENERAL MOTORS
137-AG+15	VA0140110	3786361 / 3995685	VX 0222 AA +15	VS-866	50.017.703	GENERAL MOTORS
137-AG+3	VA0140108	2787538 / 3786360	VX 0221 AA +3	VS-865	50.017.702	GENERAL MOTORS

3B	MAHLE	ORIGINAL	TRW	EATON	KS	LINHA MOTORA
1380-EC	VE0250001	59852970	VX 1628 AA	VS-993	50.017.171	FIAT
1381-EC C/O	VE0440583	7581717000				PEUGEOT
1383-EC	VE0250059	5973129	VX 2221 AA	VS-2557	50.017.737	FIAT
1420-EB	VE0210149	3803519		VS-985		CUMMINS
1420-EBS	VE0210149	3803519		VS-985		CUMMINS
1421-EB	VE0181484	7701472670				RENAULT
1422-EB	VE0700062	056.109.611.A	VX 0429 AA	VS-980	50.017.072	VOLKSWAGEN
1452-E	VE0700049	040.109.612.2	VX 0201 AA	VS-850	50.017.788	VOLKSWAGEN
1453-E	VE0700022	311.109.612	VX 0366 AD	VS-1167	50.017.738	VOLKSWAGEN
1455-ECP	VE0720157					ASIA MOTORS
1498-ACP	VA0570111	31431723 / 70910011	VX 0440 AA	VS-1423	50.017.739	FORD
1498-ACP	VA0570111	31431723 / 70910011	VX 0440 AA	VS-1423	50.017.739	PERKINS (MAXION)
1498-ACP C/O	VA0570111	31431723 / 70910011	VX 0440 AA	VS-1423	50.017.739	FORD
1498-ACP C/O	VA0570111	31431723 / 70910011	VX 0440 AA	VS-1423	50.017.739	PERKINS (MAXION)
1498-ECP	VE0570112	70910012	VX 0441 AA	VS-1424	50.017.740	FORD
1498-ECP	VE0570112	70910012	VX 0441 AA	VS-1424	50.017.740	PERKINS (MAXION)
1498-ECP C/O	VE0570112	70910012	VX 0441 AA	VS-1424	50.017.740	FORD
1498-ECP C/O	VE0570112	70910012	VX 0441 AA	VS-1424	50.017.740	PERKINS (MAXION)
1499-ECP STD	VE0570023	31431851	VX 0604 AA	VS-1161	50.017.793	GENERAL MOTORS
1499-ECP STD	VE0570023	31431851	VX 0604 AA	VS-1161	50.017.793	PERKINS (MAXION)
1561-EB	VE0110234	9L-7683				CATERPILLAR
1565-ECP	VE0130010	9.3080.460.0024	VX 0305 AA	VS-1135	50.017.199	FORD
1565-ECP	VE0130010	9.3080.460.0024	VX 0305 AA	VS-1135	50.017.199	MWM
1565-ECB	VE0130010	9.3080.460.0024	VX 0305 AA	VS-1135	50.017.199	FORD
1565-ECB	VE0130010	9.3080.460.0024	VX 0305 AA	VS-1135	50.017.199	MWM
1573-EBS	VE0110144	8N-0875		VS-1406		CATERPILLAR
1573-ABS	VA0110143	5S-6452		VS-0969		CATERPILLAR
1582-ECP	VE0710120	468303	VX 1455 AC	VS-4938	50.017.125	VOLVO
1647-AB	VA0510191	14711-413-000		VS-5006	50.017.743	HONDA
1647-EB	VE0510192	14721-413-000		VS-5007	50.017.744	HONDA
1718-A	VA0700089	078.109.601.B	VX 2975 AA	VS-4546	50.004.600	VOLKSWAGEN
175-AC	VA0250060	4239917 / 4460697	VX 2220 AA	VS-2556	50.017.714	FIAT
1815-E	VE0700087	048.109.611.C	VX 2976 AA	VS-4511	50.004.601	VOLKSWAGEN
1815-EB	VE0700016	035.109.611.F	VX 1472 AA	VS-1696	50.017.397	FORD
1815-EB	VE0700016	035.109.611.F	VX 1472 AA	VS-1696	50.017.397	VOLKSWAGEN
1815-EGX	VE0700016	035.109.611.F	VX 1472 AA	VS-1696	50.017.397	FORD
1815-EGX	VE0700016	035.109.611.F	VX 1472 AA	VS-1696	50.017.397	VOLKSWAGEN
1825-E	VE0700077	049.109.611.F	VX 1203 AA	VS-1357	50.017.386	VOLKSWAGEN
1826-AC	VA0250159	7547400	VX 2047 AB	VS-2873	50.017.745	FIAT
1826-ECB	VE0250158	7597080	VX 2392 AA	VS-2874	50.017.746	FIAT
1839-ACB	VA0480056	4220500226 / 4420500526	VX 2387 AA	VS-2520	50.017.046	MERCEDES-BENZ
1839-ACB C/O	VA0480056	4220500226 / 4420500526	VX 2387 AA	VS-2520	50.017.046	MERCEDES-BENZ
1839-ECB	VE0480055	4220500127 / 4420500227	VX 2600 AA	VS-4362		MERCEDES-BENZ
1839-ECB C/O	VE0480055	4220500127 / 4420500227	VX 2600 AA	VS-4362		MERCEDES-BENZ
1839-ECD	VE0480055	4220500127 / 4420500227	VX 2600 AA	VS-4362		MERCEDES-BENZ
1843-ECP	VE0480079	3450500127 / 7005	VX 1566 AA	VS-1128	50.017.758	MERCEDES-BENZ
1843-ECP	VE0480090	3550530005	VX 0847 AA	VS-1137	50.017.120	MERCEDES-BENZ
1843-ECP C/O	VE0480090	3550530005	VX 0847 AA	VS-1137	50.017.120	MERCEDES-BENZ
1843-ECP+0,4	VE0480079+04					MERCEDES-BENZ
1843-ECP+0,8	VE0480079+08					MERCEDES-BENZ
1861-ECB C/O	VE0710064	467855 / 8194224	VX 1085 AB	VS-4936	50.017.127	VOLVO
1861-ECP	VE0710064	467855 / 8194224	VX 1085 AB	VS-4936	50.017.127	VOLVO
2026-AC 30 C/O	VA0480006	3760530101	VX 2388 AA	VS-1814	50.017.391	MERCEDES-BENZ
2026-AC 30°	VA0480096	3760530001	VX 2390 AA (VA1648A)	VS-2587	50.017.389	MERCEDES-BENZ

3B	MAHLE	ORIGINAL	TRW	EATON	KS	LINHA MOTORA
2026-AC 30° +0,4	VA0480096+04					MERCEDES-BENZ
2026-AC 30° +0,8	VA0480096+08					MERCEDES-BENZ
21226-ECB	VE0480097	3760500027 / 3660500027	VX 2391 AA (VA1751A)	VS-2091	50.017.055	MERCEDES-BENZ
21226-ECB C/O	VE0480005	3660500227	VX 2389 AA	VS-2535	50.017.390	MERCEDES-BENZ
226-AC	VA0480004	3520530101	VX 0246 AE	VS-1177	50.017.042	MERCEDES-BENZ
226-AC C/O	VA0480004	3520530101	VX 0246 AE	VS-1177	50.017.042	MERCEDES-BENZ
229-AC	VA0480048	3460530001	VX 0383 AA	VS-1157	50.017.044	MERCEDES-BENZ
229-AC C/O	VA0480048	3460530001	VX 0383 AA	VS-1157	50.017.044	MERCEDES-BENZ
229-AC+0,4	VA0480048+04					MERCEDES-BENZ
229-AC+0,8	VA0480048+08					MERCEDES-BENZ
23108-ECPS	VE0140113	90136620/ 6621	VX 1221 AA / VX 2034 AA	VS-1658	50.017.736	GENERAL MOTORS
23109-EC	VE0140039	90323756	VX 2059 AA	VS-1984	50.017.791	GENERAL MOTORS
23109-ECP	VE0140039	90323756	VX 2059 AA	VS-1984	50.017.791	GENERAL MOTORS
23141-EC	VE0140071	90410813 / 641325	VX 2274 AA	VS-5086	50.004.484	GENERAL MOTORS
23141-ECBS	VE0140071	90410813 / 641325	VX 2274 AA	VS-5086	50.004.484	GENERAL MOTORS
23210-EBS	VE0110146	6N-9916/ 1487455		VS-2402		CATERPILLAR
23238-EB	VE0590065	026 109 611 A	VX 1813 AA	VS-2574	50.017.827	FORD
23238-EB	VE0590065	026 109 611 A	VX 1813 AA	VS-2574	50.017.827	VOLKSWAGEN
23241-ECP	VE0440581	9350111780				GENERAL MOTORS
23241-ECP	VE0440581	9350111780				PEUGEOT
23241-ECP C/O	VE0440581	9350111780				GENERAL MOTORS
23241-ECP C/O	VE0440581	9350111780				PEUGEOT
23241-ECP+0,4	VE0440581+04					GENERAL MOTORS
23241-ECP+0,4	VE0440581+04					PEUGEOT
23241-ECP+0,8	VE0440581+08					GENERAL MOTORS
23241-ECP+0,8	VE0440581+08					PEUGEOT
23242-E	VE0440588	094959				PEUGEOT
23242-EP	VE0440588	094959				PEUGEOT
23260-ECB+0,4	VE0480097	3760500027 / 3660500027	VX 2391 AA (VA1751A)	VS-2091	50.017.055	MERCEDES-BENZ
23260-ECB	VE0480005	3660500227	VX 2389 AA	VS-2535	50.017.390	MERCEDES-BENZ
23260-ECB	VE0480097	3760500027 / 3660500027	VX 2391 AA (VA1751A)	VS-2091	50.017.055	MERCEDES-BENZ
23260-ECB C/O	VE0480005	3660500227	VX 2389 AA	VS-2535	50.017.390	MERCEDES-BENZ
23260-ECB+0,4	VE0480005+04					MERCEDES-BENZ
23260-ECB+0,4	VE0480097+04					MERCEDES-BENZ
23260-ECB+0,8	VE0480005+08					MERCEDES-BENZ
23260-ECB+0,8	VE0480097+08					MERCEDES-BENZ
23293-AP	VA0510045	14711-383-000	VX 0786 AA	VS-4906	50.017.778	HONDA
23293-EP	VE0510046	14721-383-000	VX 0787 AA	VS-4918	50.017.779	HONDA
23301-ECB	VE0440585	9153501980				CITROËN
23301-ECB	VE0440585	9153501980				PEUGEOT
23309-ECBS	VE0180305					RENAULT
23345-ECB	VE0570230	70910054		VS-4892	50.017.847	FORD
23345-ECB	VE0570230	70910054		VS-4892	50.017.847	GENERAL MOTORS
23345-ECB	VE0570230	6010532827		VS-4892	50.017.847	MERCEDES-BENZ
23345-ECB	VE0570230	70910076		VS-4892	50.017.847	PERKINS (MAXION)
23345-ECBS	VE0570230	70910054		VS-4892	50.017.847	FORD
23345-ECBS	VE0570230	70910054		VS-4892	50.017.847	GENERAL MOTORS
23345-ECBS	VE0570230	6010532827		VS-4892	50.017.847	MERCEDES-BENZ
23345-ECBS	VE0570230	70910076		VS-4892	50.017.847	PERKINS (MAXION)
23394-ACB	VA0760013	352211 / 352212 / 294674 / 289483	VX 1784 AA	VS-4905	50.017.789	SCANIA
23394-ACBS	VA0760013	352211 / 352212 / 294674 / 289483	VX 1784 AA	VS-4905	50.017.789	SCANIA
23395-ECS	VE0760012	1100997 / 1360834 / 232018	VX 2019 AA	VS-5166	50.017.790	SCANIA

3B	MAHLE	ORIGINAL	TRW	EATON	KS	LINHA MOTORA
23395-ECSS	VE0760012	1100997 / 1360834 / 232018	VX 2019 AA	VS-5166	50.017.790	SCANIA
23407-EBN	VE0510131	14721-471-000		VS-5001	50.017.780	HONDA
23407-ECSS	VE0510131	14721-471-000		VS-5001	50.017.780	HONDA
23409-ECB	VE0510117	14721-437-0000	VX 0990 AA	VS-4997	50.017.781	HONDA
23409-ECSS	VE0510117	14721-437-0000	VX 0990 AA	VS-4997	50.017.781	HONDA
23411-EBN	VE0510133	14721-KGO-000		VS-5003	50.017.782	HONDA
23411-ECSS	VE0510133	14721-KGO-000		VS-5003	50.017.782	HONDA
23417-ECB	VE0510030	14721-KYO-8901-R	VX 2325 AA	VS-4994	50.017.783	HONDA
23417-ECBS	VE0510030	14721-KYO-8901-R	VX 2325 AA	VS-4994	50.017.783	HONDA
23419-ECSS	VE0510135	14721-KFO-000		VS-5005	50.017.784	HONDA
23423-ECB	VE0130100	9.610.0.460.002.4	VX 2124 AA	VS-2824	50.017.844	MWM
23423-ECB	VE0130100	9.610.0.460.002.4	VX 2124 AA	VS-2824	50.017.844	VOLKSWAGEN
23423-ECBS	VE0130100	9.610.0.460.002.4	VX 2124 AA	VS-2824	50.017.844	MWM
23423-ECBS	VE0130100	9.610.0.460.002.4	VX 2124 AA	VS-2824	50.017.844	VOLKSWAGEN
247-A	VA0570035	31431261 / 0910001	VX 0092 AB	VS-620		PERKINS (MAXION)
247-A C/O	VA0570035	31431261 / 0910001	VX 0092 AB	VS-620		PERKINS (MAXION)
247-A C/P	VA0570032	70910001/4	VX 0256 AA	VS-887	50.017.704	PERKINS (MAXION)
247-A+0.4	VA0570035+04					PERKINS (MAXION)
247-A+0.8	VA0570035+08					PERKINS (MAXION)
248-E	VE0570036	0910002	VX 0091 AA	VS-618	50.017.705	PERKINS (MAXION)
248-E C/O	VE0570036	0910002	VX 0091 AA	VS-618	50.017.705	PERKINS (MAXION)
248-E C/P	VE0570031	70910002	VX 0257 AA	VS-886	50.017.706	PERKINS (MAXION)
249-AC	VA0570024	31431315	VX 0602 AA	VS-1160	50.017.792	GENERAL MOTORS
249-AC	VA0570024	31431315	VX 0602 AA	VS-1160	50.017.792	PERKINS (MAXION)
249-AC C/O	VA0570038	70910017	VX 1912 AA	VS-2815	50.017.769	GENERAL MOTORS
249-AC C/O	VA0570038	70910017	VX 1912 AA	VS-2815	50.017.769	PERKINS (MAXION)
250-A	VA0570033	0910030 / 0910069	VX 0090 AA	VS-1754	50.017.707	FORD
250-A	VA0570033	0910030 / 0910069	VX 0090 AA	VS-1754	50.017.707	PERKINS (MAXION)
250-AMF	VA0570033	0910030 / 0910069	VX 0090 AA	VS-1754	50.017.707	FORD
250-AMF	VA0570033	0910030 / 0910069	VX 0090 AA	VS-1754	50.017.707	PERKINS (MAXION)
251-E	VE0570034	0910041 / 0910073	VX 0087 AA	VS-457	50.017.727	FORD
251-E	VE0570034	0910041 / 0910073	VX 0087 AA	VS-457	50.017.727	PERKINS (MAXION)
3036-A	VA0590043	84AU-6507-A	VX 1320 AA	VS-2489	50.017.747	FORD
3037-EP	VE0590042	84AU-6505-A	VX 1319 AA	VS-2465	50.017.748	FORD
3038-A	VA0590093	59112	VX 0250 AA	VS-1205	50.017.749	FORD
303-AC	VA0700082	068.109.601.C	VX 1210 AA	VS-1358	50.017.016	VOLKSWAGEN
3042-AC	VA0590275					FORD
3043-ECP	VE0590276	F77Z-6505-AA / 90TM-6505-AB				FORD
3045-ECP	VE0130010	9.3080.460.0024	VX 0305 AA	VS-1135	50.017.199	FORD
3045-ECP	VA0140041	52285384	VX 2034 AA	VS-1660	50.017.753	GENERAL MOTORS
3045-ECP	VE0130010	9.3080.460.0024	VX 0305 AA	VS-1135	50.017.199	MWM
3052-AC	VA0590181	89BM-6507AA	V76175A0		50.017.854	FORD
3053-ECB	VE0590173	97BM-6505-AA	VX 4010 AA			FORD
3054-AC	VA0590172	89BM-6507AA	VX 4009 AA			FORD
3062-AC	VA0590170	XS6E6507AA	V76175A0			FORD
3063-EC	VE0590171	XS6E6505AB / 7S6G.6505.AA	V76176A0			FORD
3063-ECB	VE0590171	XS6E6505AB / 7S6G.6505.AA	V76176A0			FORD
3064-AC	VA0590179	97MM6507BB2B	VX 4006 AA		50.017.870	FORD
3065-EN	VE0590178	X56G6505B2A			50.017.801	FORD
3066-AC	VA0590180	928M-650-F2-A		VS-5294		FORD
3067-EC	VE0590182	948M-6505-D2A		VS-5295		FORD
3067-ECB	VE0590182	948M-6505-D2A		VS-5295		FORD
3068-AC	VA0590180	928M-650-F2-A		VS-5294		FORD
3068-AC	VA0590255	1S7Z-6507-AA				FORD

3B	MAHLE	ORIGINAL	TRW	EATON	KS	LINHA MOTORA
3069-ECB	VE0590182	948M-6505-D2A		VS-5295		FORD
3069-ECB	VE0590256	1S7Z-6505-AA				FORD
3070-AC	VA0591461	F57Z-6507-A				FORD
3071-ECP	VE0591462	F57Z-6505-A				FORD
3082-AC	VA0590180	928M-650-F2-A		VS-5294		FORD
3090-AC	VA0590179	97MM6507BB2B	VX 4006 AA		50.017.870	FORD
3091-ECB	VE0590178	X56G6505B2A			50.017.801	FORD
3092-AC	VA0590174		V74469A0	VS-4939		FORD
3093-EC	VE0590175	XS6E6505BB / YS4E.6505.BA	V74470A0	VS-5127		FORD
3093-ECBS	VE0590175	XS6E6505BB / YS4E.6505.BA	V74470A0	VS-5127		FORD
3094-AC	VA0590255	1S7Z-6507-AA				FORD
3095-EC	VE0590256	1S7Z-6505-AA				FORD
3108-AC	VA0140114	90136614/ 6613	VX 1220 AA	VS-1415	50.017.713	GENERAL MOTORS
3109-AC	VA0140040	90220119	VX 1699 AA	VS-1980	50.017.752	GENERAL MOTORS
3110-AC	VA0140041	52285384	VX 2034 AA	VS-1660	50.017.753	GENERAL MOTORS
3136-AC	VA0140015	90323518 / 642763	VX 2332 AA	VS-4261	50.017.754	GENERAL MOTORS
3137-E	VE0140014	90.323.523 / 642890	VX 2333 AA	VS-4262	50.017.755	GENERAL MOTORS
3137-ECB	VE0140014	90.323.523 / 642890	VX 2333 AA	VS-4262	50.017.755	GENERAL MOTORS
3138-AC	VA0140076	90412712	VX 2463 AA	VS-4901	50.017.837	GENERAL MOTORS
3139-EC	VE0140075	90412974	VX 2925 AA		50.017.838	GENERAL MOTORS
3140-AC	VA0140072	90412277 / 641022	VX 2909 AA	VS-5094	50.004.483	GENERAL MOTORS
3146-AC	VA0140086	7083246 / 90215492	VX 2331 AA	VS-4899	50.017.835	FIAT
3146-AC	VA0140086	90215492 / 7083246	VX 2331 AA	VS-4899	50.017.835	GENERAL MOTORS
3147-ECB	VE0140370	7083242				FIAT
3147-ECB	VE0140085	90324412	VX 2334 AA	VS-4900	50.017.836	GENERAL MOTORS
3163-ECP	VE0140184	12550909				GENERAL MOTORS
3164-AC	VA0140183	10241743				GENERAL MOTORS
3210-A	VA0110145	6N-9915		VS-2401		CATERPILLAR
3234-AC	VA0250018	46470637 / 46559031	VX 2028 AA	VS-4897	50.017.756	FIAT
3238-A	VA0700088	048.109.601.E	VX 2923 AA	VS-4510	50.004.599	VOLKSWAGEN
3241-AC	VA0440567	9350111580/ 480				GENERAL MOTORS
3241-AC	VA0440567	9350111580/ 480				PEUGEOT
3241-AC C/O	VA0440567	9350111580/ 480				GENERAL MOTORS
3241-AC C/O	VA0440567	9350111580/ 480				PEUGEOT
3241-AC+0,4	VA0440567+04					GENERAL MOTORS
3241-AC+0,4	VA0440567+04					PEUGEOT
3241-AC+0,8	VA0440567+08					GENERAL MOTORS
3241-AC+0,8	VA0440567+08					PEUGEOT
3242-A	VA0441091	094891				PEUGEOT
3260-ACB	VA0480006	3760530101	VX 2388 AA	VS-1814	50.017.391	MERCEDES-BENZ
3260-ACB 20 C/O	VA0480006	3760530101	VX 2388 AA	VS-1814	50.017.391	MERCEDES-BENZ
3260-ACB C/O	VA0480007	366.050.1226	VX 2811 AA	VS-2770	50.017.794	MERCEDES-BENZ
3260-ACB+0,4	VA0480006+04					MERCEDES-BENZ
3260-ACB+0,8	VA0480006+08					MERCEDES-BENZ
3260-ACB-20°	VA0480007	366.050.1226	VX 2811 AA	VS-2770	50.017.794	MERCEDES-BENZ
3262-AC	VA0480080	3450537001	VX 1565 AA	VS-1129	50.017.757	MERCEDES-BENZ
3262-AC	VA0480091	3550530001	VX 0846 AA	VS-1136	50.017.119	MERCEDES-BENZ
3262-AC C/O	VA0480080	3450537001	VX 1565 AA	VS-1129	50.017.757	MERCEDES-BENZ
3263-ECB	VE0480079	3450500127 / 7005	VX 1566 AA	VS-1128	50.017.758	MERCEDES-BENZ
3263-ECB	VE0480090	3550530005	VX 0847 AA	VS-1137	50.017.120	MERCEDES-BENZ
3263-ECB C/O	VE0480079	3450500127 / 7005	VX 1566 AA	VS-1128	50.017.758	MERCEDES-BENZ
326-A	VA0590094	78MU-6507-A	VX 0756 AA	VS-1132	50.017.708	FORD
3272-A	VA0230119	800558	VX 0023 AA	VS-0016	50.017.759	FORD WILLYS
3272-E	VE0230118	800558	VX 0088 AA	VS-770	50.017.760	FORD WILLYS
3272-E	VE0230118	B-27220	VX 0088 AA	VS-770	50.017.760	JEEP
3273-E	VE0230118	800558	VX 0088 AA	VS-770	50.017.760	FORD WILLYS

3B	MAHLE	ORIGINAL	TRW	EATON	KS	LINHA MOTORA
3273-E	VE0230118	B-27220	VX 0088 AA	VS-770	50.017.760	JEEP
3296-AN	VA0720154				50.017.857	ASIA MOTORS
3297-EBN	VE0720155				50.017.858	ASIA MOTORS
3298-AN	VA2110229	K710-12-111		VS-5284	50.017.866	KIA MOTORS
3298-AN	VA2110229	K710-12-111		VS-5284	50.017.866	MAZDA
3299-EN	VE2110249	K710-12-121				KIA MOTORS
3299-EN	VE2110249	K710-12-121				MAZDA
3301-AC	VA0440551	9153501780				CITROËN
3301-AC	VA0440551	9153501780				PEUGEOT
3303-EC	VE0440585	9153501980				CITROËN
3303-EC	VE0440585	9153501980				PEUGEOT
3304-A	VA0440551	9153501780				CITROËN
3304-A	VA0440551	9153501780				PEUGEOT
3308-AC	VA0180389	7702220678				RENAULT
3310-A	VA0700088	048.109.601.E	VX 2923 AA	VS-4510	50.004.599	VOLKSWAGEN
3312-A	VA0590066	035109601G	VX 1812 AB	VS-4762	50.017.826	FORD
3312-A	VA0590066	035109601G	VX 1812 AB	VS-4762	50.017.826	VOLKSWAGEN
3313-A	VA0700089	078.109.601.B	VX 2975 AA	VS-4546	50.004.600	VOLKSWAGEN
3320-AC	VA0250052	7722907	VX 2607 AA	VS-4530	50.017.761	FIAT
3321-ECB	VE0250051	7574742	VX 2608 AA	VS-4531	50.017.762	FIAT
3326-A	VA0060903	7006.00600500.3				AGRALE
3327-E	VE0060323	7006.00600600.1				AGRALE
332-AC	VA0140084	94621104/ 1038	VX 1550 AA	VS-1299	50.017.710	GENERAL MOTORS
332-AC+06	VA0140084 0,152	94621041				GENERAL MOTORS
332-AC+10	VA0140084 0,254					GENERAL MOTORS
332-AC+12	VA0140084 0,304	94621607				GENERAL MOTORS
332-AC+15	VA0140084 0,381					GENERAL MOTORS
332-AC+20	VA0140084 0,508					GENERAL MOTORS
332-AC+3	VA0140084 0,076	94621039/ 1040				GENERAL MOTORS
332-AC+30	VA0140084 0,762					GENERAL MOTORS
332-AC+5	VA0140084 0,127					GENERAL MOTORS
3334-AC	VA0210153	3924492 / 3802463		VS-4309		CUMMINS
3334-AC	VA0210153	3924492 / 3902253		VS-4309		FORD
3334-AC	VA0210153	3924492 / 3802463		VS-4309		VOLKSWAGEN
3335-ECP	VE0210152	3921444 / 3802085		VS-4308		CUMMINS
3335-ECP	VE0210152	3921444 / 3902254		VS-4308		FORD
3335-ECP	VE0210152	3921444 / 3802085		VS-4308		VOLKSWAGEN
3342-AC	VA0570123	70910025/ 35	VX 2299 AA	VS-2831	50.017.894	GENERAL MOTORS
3342-AC	VA0570123	70910025/ 35	VX 2299 AA	VS-2831	50.017.894	PERKINS (MAXION)
3344-ACB	VA0570250	70910053				FORD
3344-ACB	VA0570250	70910053				GENERAL MOTORS
3344-ACB	VA0570250	6010531901				MERCEDES-BENZ
3344-ACB	VA0570250	70910053				PERKINS (MAXION)
3388-ACB	VA0570657	70910096 (70910037)				GENERAL MOTORS
3388-ACB	VA0570657	70910096 (70910037)				PERKINS (MAXION)
3389-ECB	VE0570122	70910038	VX 2298 AA	VS-2833	50.017.766	GENERAL MOTORS
3389-ECB	VE0570122	70910038	VX 2298 AA	VS-2833	50.017.766	PERKINS (MAXION)
3390-AC	VA0130099	622804603014	VX 0692 AA	VS-2696	50.017.767	MWM
3391-ECB	VE0130098	9.229.0.460.003.4	VX 1975 AA	VS-2695	50.017.768	MWM
3392-AC	VA0570038	70910017	VX 1912 AA	VS-2815	50.017.769	GENERAL MOTORS
3392-AC	VA0570038	70910017	VX 1912 AA	VS-2815	50.017.769	PERKINS (MAXION)
3393-ECB	VE0570037	70910018	VX 1913 AA	VS-2816	50.017.770	GENERAL MOTORS
3393-ECB	VE0570037	70910018	VX 1913 AA	VS-2816	50.017.770	PERKINS (MAXION)
3406-AN	VA0510130	14711-428-000		VS-5000	50.017.771	HONDA
3408-AC	VA0510115	14711-440-0030-BR	VX 0989 AA	VS-4985		HONDA
3408-AC	VA0510116	14711-397-6300	VX 1473 AA	VS-4917	50.017.772	HONDA
3410-AN	VA0510132	14711-KGO-000		VS-5002	50.017.773	HONDA
3410-ANS	VA0510132	14711-KGO-000		VS-5002	50.017.773	HONDA

3B	MAHLE	ORIGINAL	TRW	EATON	KS	LINHA MOTORA
3416-AC	VA0510029	14711-KYO-8901-R	VX 2324 AA	VS-4993	50.017.774	HONDA
3418-ACS	VA0510134	14711-KL3-670		VS-5004	50.017.843	HONDA
3422-AC	VA0130101	9.610.0.460.003.4	VX 2123 AA	VS-2825	50.017.844	MWM
3422-AC	VA0130101	9.610.0.460.003.4	VX 2123 AA	VS-2825	50.017.844	VOLKSWAGEN
3432-A	VA0510209	14711-PO8000				HONDA
3433-EBN	VE0510210	14721-PO8000 / 14721-P2A-000			50.017.635	HONDA
344-AC	VA0140114	90136614/ 6613	VX 1220 AA	VS-1415	50.017.713	GENERAL MOTORS
344-AC+15	VA0140114 0,381	90136616				GENERAL MOTORS
344-AC+3	VA0140114 0,076	90136615				GENERAL MOTORS
344-AC+30	VA0140114 0,762	90136617				GENERAL MOTORS
3452-A	VA0180423	7700855926				RENAULT
3453-EB	VE0180424	7700855927				RENAULT
3464-AN	VA1950261	MD-159502				MITSUBISHI
3465-EBM	VE1950262	MD-197106				MITSUBISHI
3465-EBN	VE1950262	MD-197106				MITSUBISHI
3466-AC	VA0210151	3920867 / 3802355		VS-4307		CUMMINS
3466-AC	VA0210151	3920867 / 3802356		VS-4307		FORD
3466-AC	VA0210151	3920867 / 3802356		VS-4307		VOLKSWAGEN
3466-AC C/O	VA0210151	3920867 / 3802355		VS-4307		CUMMINS
3466-AC C/O	VA0210151	3920867 / 3802356		VS-4307		FORD
3466-AC C/O	VA0210151	3920867 / 3802356		VS-4307		VOLKSWAGEN
3467-ECB	VE0210150	3920868 / 3802356		VS-4306		CUMMINS
3467-ECB	VE0210150	3920868 / 3802356		VS-4306		FORD
3467-ECB	VE0210150	3920868 / 3802356		VS-4306		VOLKSWAGEN
3467-ECB C/O	VE0210150	3920868 / 3802356		VS-4306		CUMMINS
3467-ECB C/O	VE0210150	3920868 / 3802356		VS-4306		FORD
3467-ECB C/O	VE0210150	3920868 / 3802356		VS-4306		VOLKSWAGEN
3484-A	VA0700088	048.109.601.E	VX 2923 AA	VS-4510	50.004.599	VOLKSWAGEN
3484-AB	VA0700088	048.109.601.E	VX 2923 AA	VS-4510	50.004.599	VOLKSWAGEN
3485-EB	VE0700087	048.109.611.C	VX 2976 AA	VS-4511	50.004.601	VOLKSWAGEN
3485-EBS	VE0700087	048.109.611.C	VX 2976 AA	VS-4511	50.004.601	VOLKSWAGEN
3485-EBS	VE0700190	048.109.611.B				VOLKSWAGEN
3486-A	VA0700088	048.109.601.E	VX 2923 AA	VS-4510	50.004.599	VOLKSWAGEN
3486-A	VA0700089	078.109.601.B	VX 2975 AA	VS-4546	50.004.600	VOLKSWAGEN
3488-AS	VA0700242	058.109.601.C			50.004.507	AUDI
3488-AS	VA0700242	058.109.601.C			50.004.507	VOLKSWAGEN
3489-EC	VE0700243	058.109.611.E			50.004.508	AUDI
3489-EC	VE0700243	058.109.611.E			50.004.508	VOLKSWAGEN
3489-ECBS	VE0700243	058.109.611.E			50.004.508	AUDI
3489-ECBS	VE0700243	058.109.611.E			50.004.508	VOLKSWAGEN
3508-A	VA0700009	036.109.601.R	VX 2875 AA	VS-5127	50.017.860	VOLKSWAGEN
3509-E	VE0700008	036.109.611.J	VX 2989 AA	VS-5223	50.017.861	VOLKSWAGEN
3509-EB	VE0700008	036.109.611.J	VX 2989 AA	VS-5223	50.017.861	VOLKSWAGEN
3510-ACB	VA0010211	7301820	VX 4011 AA			IVECO
3510-ACB	VA0010211	7301820	VX 4011 AA			PEUGEOT
3512-A	VA0700028	030.109.601.AC	VX 2930 AA	VS-4919	50.017.849	VOLKSWAGEN
3513-EB	VE0700027	030.109.611.AC	VX 2931 AA	VS-4856	50.017.853	VOLKSWAGEN
3514-AC	VA0250165		VX 4004 AA		50.017.869	FIAT
3515-EC	VE0250164		VX 4005 AA			FIAT
3526-A	VA0180393	8200708663			50.017.935	RENAULT
3527-E	VE0180310	8200708662			50.017.936	RENAULT
3540-A	VA0440561	094892 / 9628943380				PEUGEOT
3541-EC	VE0440297	0949A6 / 962981180				PEUGEOT
3541-ECB	VE0440297	0949A6 / 962981180				PEUGEOT
3542-A	VA0440557	094866 / 9605936180				PEUGEOT
3543-ECB	VE0440589	094972 / 9605936280				PEUGEOT
3546-AC	VA0130277	9.4070.460.0034				GENERAL MOTORS
3546-AC	VA0130277	9.4070.460.0034				MWM

3B	MAHLE	ORIGINAL	TRW	EATON	KS	LINHA MOTORA
3547-ECB	VE0130278	9.4070.460.0024				GENERAL MOTORS
3547-ECB	VE0130278	9.4070.460.0024				MWM
3547-ECBS	VE0130278	9.4070.460.0024				GENERAL MOTORS
3547-ECBS	VE0130278	9.4070.460.0024				MWM
3548-APN	VA2110185	ON01-12-111		VS-5281	50.017.850	KIA MOTORS
3548-APN	VA2110185	ON01-12-111		VS-5281	50.017.850	MAZDA
3548-EBN	VE2110186	ON01-12-121		VS-5282	50.017.851	KIA MOTORS
3548-EBN	VE2110186	ON01-12-121		VS-5282	50.017.851	MAZDA
3549-EBN	VE2110186	ON01-12-121		VS-5282	50.017.851	KIA MOTORS
3549-EBN	VE2110186	ON01-12-121		VS-5282	50.017.851	MAZDA
3558-AC	VA0250166	46553048		VS-5085		FIAT
3559-EC	VE0250163	46553049		VS-5088		FIAT
3559-ECBS	VE0250163	46553049		VS-5088		FIAT
3576-A	VA0440569	094861 / 9626052980				PEUGEOT
3577-ECB	VE0440301	094962 / 9629861180				PEUGEOT
3578-AC	VA0140026	93248325	VX 2996 AA			GENERAL MOTORS
3579-EC	VE0140025	93248326	VX 2997 AA			GENERAL MOTORS
3579-ECB	VE0140025	93248326	VX 2997 AA			GENERAL MOTORS
3580-AN	VA1950247	ME-202687				MITSUBISHI
3581-EBN	VE1950246	ME-202688				MITSUBISHI
3586-ACB	VA0250513	98468338				CITROËN
3586-ACB	VA0250513	98468338				FIAT
3586-ACB	VA0250513	98468338				IVECO
3586-ACB	VA0250513	98468338				PEUGEOT
3586-ACB	VA0250513	98468338				RENAULT
3587-ECB	VE0010212	99432837EC54-0652	VX 4014 AA			IVECO
3587-ECB	VE0010212	99432837EC54-0652	VX 4014 AA			PEUGEOT
3594-AN	VA2080849	22211-42520				HYUNDAI
3595-EP	VE2080848	22212-42520				HYUNDAI
3598-A	VA0180124	7701471378 / 7700107602	VX 3101 AA			RENAULT
3599-E	VE0180125	7701473354 / 8200054762	VX 3102 AA			RENAULT
3599-EB	VE0180125	7701473354 / 8200054762	VX 3102 AA			RENAULT
3600-AC	VA0250160	7735898	VX 4000 AA			FIAT
3601-ECB	VE0250161	7735899	VX 4001 AA			FIAT
3601-ECBS	VE0250161	7735899	VX 4001 AA			FIAT
3602-A	VA0590067	026109601D	VX 1947 AA	VS-2639		FORD
3602-A	VA0590067	026109601D	VX 1947 AA	VS-2639		VOLKSWAGEN
3614-AC	VA0110232	7W-8064		VS-3124		CATERPILLAR
3614-AC	VA0110232	7W-8064		VS-3124		GENERAL MOTORS
3615-EC	VE0110233	136-0819		VS-3140		CATERPILLAR
3615-EC	VE0110233	136-0819		VS-3140		GENERAL MOTORS
3616-A	VA0440578	0948A9				CITROËN
3616-A	VA0440578	0948A9				PEUGEOT
3617-EBS	VE0440598	0949A8				CITROËN
3617-EBS	VE0440598	0949A8				PEUGEOT
3617-ECBS	VE0440598	0949A8				CITROËN
3617-ECBS	VE0440598	0949A8				PEUGEOT
3618-AC	VA0430546	R-98062				JOHN DEERE
3619-ECB	VE0430542	R-90692				JOHN DEERE
3620-A	VA0180421	7701469266				RENAULT
3621-EB	VE0180422	7701469269				RENAULT
3624-AC	VA0010211	7301820	VX 4011 AA			IVECO
3624-AC	VA0010211	7301820	VX 4011 AA			PEUGEOT
3625-EC	VE0010212	99432837EC54-0652	VX 4014 AA			IVECO
3625-EC	VE0010212	99432837EC54-0652	VX 4014 AA			PEUGEOT
3658-AN	VA0480233	6110530101				MERCEDES-BENZ

3B	MAHLE	ORIGINAL	TRW	EATON	KS	LINHA MOTORA
3659-EN	VE0480251	6110530005				MERCEDES-BENZ
3662-ACB	VA0760103	1515743 / 1333230	VX 2750 AA		50.009.016	SCANIA
3663-ECBS	VA0760103	1515743 / 1333230	VX 2750 AA		50.009.016	SCANIA
3663-ECBS	VE0760102	1328537	VX 2751 AA			SCANIA
3693-E	VC0481565	A4420160391				MERCEDES-BENZ
3714-A	VA0180395					RENAULT
3715-EB	VE0180396	7700865449				RENAULT
3716-AC	VA0180395					RENAULT
3717-ECB	VE0180396	7700865449				RENAULT
3720-AN	VA1950223	MD198404				MITSUBISHI
3721-EBN	VE2080848	22212-42520				HYUNDAI
3721-EBN	VE1950224	MD-198406				MITSUBISHI
3736-AC	VA0250168	60811153 / 7766564	VX 4002 AA			ALFA ROMEO
3736-AC	VA0250168	60811153 / 7766564	VX 4002 AA			FIAT
3737-ECB	VE0250169	60811154 / 7766565	VX 4003 AA			ALFA ROMEO
3737-ECB	VE0250169	60811154 / 7766565	VX 4003 AA			FIAT
3737-ECBS	VE0250169	60811154 / 7766565	VX 4003 AA			ALFA ROMEO
3737-ECBS	VE0250169	60811154 / 7766565	VX 4003 AA			FIAT
3774-AC	VA0140072	90412277 / 641022	VX 2909 AA	VS-5094	50.004.483	GENERAL MOTORS
3775-ECBS	VE0140071	90410813 / 641325	VX 2274 AA	VS-5086	50.004.484	GENERAL MOTORS
3778-AN	VA0630240	13711-17010				TOYOTA
3779-EBN	VE0630241	13715-17010				TOYOTA
3798-A	VA0441091	094891				PEUGEOT
3800-AC	VA0250162	46553046	VX 3128 AA	VS-5087		FIAT
3801-EC	VE0250167	46553047	VX 3129 AA	VS-5086		FIAT
3802-ACB	VA0760215	1319081				SCANIA
3803-ECS	VE0760216	1360833				SCANIA
380-AC	VA0250002	43401180	VX 0514 AB	VS-992	50.017.170	FIAT
3814-AC	VA0590180	928M-650-F2-A		VS-5294		FORD
3815-EC	VE0590182	948M-6505-D2A		VS-5295		FORD
381-AC	VA0440566	7932582418				PEUGEOT
381-AC C/O	VA0440566	7932582418				PEUGEOT
381-AC+0,4	VA0440566+04					PEUGEOT
381-AC+0,8	VA0440566+08					PEUGEOT
3826-AN	VA2110185	ON01-12-111		VS-5281	50.017.850	KIA MOTORS
3826-AN	VA2110185	ON01-12-111		VS-5281	50.017.850	MAZDA
3827-EBN	VE2110188	OK63C-12-121		VS-5297		KIA MOTORS
3828-AN	VA2110187	OK65D12111		VS-5296		KIA MOTORS
3838-AN	VA0510195	14711-KGA-B000-R	VX 3207 AA			HONDA
3839-EN	VE0510196	14721-KGA-B000-R	VX 3208 AA			HONDA
383-AC	VA0250060	4239917 / 4460697	VX 2220 AA	VS-2556	50.017.714	FIAT
3846-AC	VA0480244	9060500326	VX 3004 AB			MERCEDES-BENZ
3847-ECB	VE0480245	9060500327				MERCEDES-BENZ
3854-AN	VA0510209	14711-PO8000				HONDA
3855-EBN	VE0510210	14721-PO8000 / 14721-P2A-000			50.017.635	HONDA
3856-AC	VA0480193	5410500226		VS-5037		MERCEDES-BENZ
3857-ECB	VE0480194	5410500227	VX 2951 AB	VS-5225		MERCEDES-BENZ
3858-ACB	VA0570231	70910081				FORD
3858-ACB	VA0570231	70910081				PERKINS (MAXION)
3859-EBN	VE0570232	70910080				FORD
3859-EBN	VE0570232	70910080				PERKINS (MAXION)
3859-EC	VE0570232	70910080				FORD
3859-EC	VE0570232	70910080				PERKINS (MAXION)
3862-A	VA0181606 (VA0180427)	13201-00Q0H / 7701472986				NISSAN

3B	MAHLE	ORIGINAL	TRW	EATON	KS	LINHA MOTORA
3862-A	VA0181606 (VA0180427)	7701472986 / 13201-00Q0H				RENAULT
3863-EB	VE0181607 (VE0180438)	13202-00Q0K / 7701473004				NISSAN
3863-EB	VE0181607 (VE0180438)	7701473004 / 13202-00Q0K				RENAULT
3864-A	VA0180415	7701471279				RENAULT
3865-E	VE0180416	7701471280				RENAULT
3865-EB	VE0180416	7701471280				RENAULT
3868-A	VA0701421	030.109.601.AS	V75154A0			VOLKSWAGEN
3869-EB	VE0701422	030.109.611.AG	V75155A0			VOLKSWAGEN
3870-A	VA0700074	036.109.601.AE	VX 3090 AA			VOLKSWAGEN
3871-EB	VE0700073	036.109.611.T	VX 3091 AA			VOLKSWAGEN
3874-EC	VC0481344	A9060160791				MERCEDES-BENZ
3875-EC	VC0481345	A5410160791				MERCEDES-BENZ
3884-A	VA0440579	0948.99 / 0948.F4				CITROËN
3884-A	VA0440579	0948.99 / 0948.F4				PEUGEOT
3885-ECB	VE0441603 (VE0440599)	0949.99 / 0949.E9				CITROËN
3885-ECB	VE0441603 (VE0440599)	0949.99 / 0949.E9				PEUGEOT
3886-A	VA0700252	032.109.601.M	VX 3066 AA	VS-4893	50.017.846	VOLKSWAGEN
3887-EB	VE0700268	032.109.611.Q / 032.109.611.N	V75153A0			VOLKSWAGEN
3887-E	VE0700253	032.109.611.L	VX 3092 AA			VOLKSWAGEN
3892-AN	VA0630259	13711-58021				TOYOTA
3893-EPN	VE0630260	13715-58041				TOYOTA
3896-AN	VA2080849	22211-42520				HYUNDAI
3897-EN	VE2080848	22212-42520				HYUNDAI
3904-AC	VA0510197	14711-KRM-8400	VX 3273 AA			HONDA
3905-ECB	VE0510198	17421-KRM-8400	VX 3274 AA			HONDA
3912-AC	VA0140086	7083246 / 90215492	VX 2331 AA	VS-4899	50.017.835	FIAT
3912-AC	VA0251614	7085036 / 90232975 / 93399246				FIAT
3912-AC	VA0140086	90215492 / 7083246	VX 2331 AA	VS-4899	50.017.835	GENERAL MOTORS
3913-ECB	VE0140370	7083242				FIAT
3914-ACB	VA0710203	1547492	VX 4017 AA	VS-5143	50.017.689	VOLVO
3915-ECB	VE0710201	8148574 / 20441945	VX 4018 AA	VS-4968	50.017.667	VOLVO
3924-A	VA0060904	7007.00600500.1				AGRALE
3925-E	VE0060907	7007.00600600.9				AGRALE
3950-AN	VA0520199	5HH-12111-00	VX 3285 AA			YAMAHA
3951-ESN	VE0520200	5HH-12121-00	VX 3286 AA			YAMAHA
3952-AN	VA0510128	14711-KPF-9000-RW1	VX 3131 AA			HONDA
3953-EBN	VE0510129	14721-KPF-9000-RW1	VX 3132 AA			HONDA
3956-AC	VA0250271	55195497	V76562A0			FIAT
3957-ECB	VE0250272	55195498	V76563A0			FIAT
3968-AC	VA0381304	1823875-C1				INTERNATIONAL
3972-A	VA0700758	030.109.601.G				SEAT
3972-A	VA0700758	030.109.601.G				VOLKSWAGEN
3973-EX	VE0701141	030.109.611.D				SEAT
3973-EX	VE0701141	030.109.611.D				VOLKSWAGEN
3974-AN	VA0630205	13711-15090				TOYOTA
3975-EN	VE0630206	13715-16060				TOYOTA
3975-EN	VE0630208	13715-22030				TOYOTA
3976-AC	VA0210442	3940735		VS-5102		CUMMINS
3977-ECB	VE0210443	3940734				CUMMINS
3997-EC	VE0250272	55195498	V76563A0			FIAT
3997-ECB	VE0250272	55195498	V76563A0			FIAT
3998-AC	VA0250166	46553048		VS-5085		FIAT

3B	MAHLE	ORIGINAL	TRW	EATON	KS	LINHA MOTORA
3999-ECB	VE0250163	46553049		VS-5088		FIAT
4004-AC	VA0140015	90323518 / 642763	VX 2332 AA	VS-4261	50.017.754	GENERAL MOTORS
4005-EC	VE0140014	90.323.523 / 642890	VX 2333 AA	VS-4262	50.017.755	GENERAL MOTORS
4006-AC	VA0141396	93399245	V75591A0			GENERAL MOTORS
4007-EC	VE0141397	93399247	V76379A0			GENERAL MOTORS
4007-ECB	VE0141397	93399247	V76379A0			GENERAL MOTORS
4010-A	VA0440575	96101886 / 96183535				CITROËN
4010-A	VA0440575	96101886 / 96183535				PEUGEOT
4011-ECB	VE0440596	96101887				CITROËN
4011-ECB	VE0440596	96101887				PEUGEOT
4016-AN	VA0630213	13711-0L020				TOYOTA
4017-EN	VE0630214	13715-0L020				TOYOTA
4018-AN	VA0631453	13711-0L010 / 13711-30040				TOYOTA
4019-EN	VE0631454	13715-0L010 / 13715-30040				TOYOTA
4024-AC	VA0211371	3942588 / 3800340				CUMMINS
4025-ECB	VE0211372	3942589 / 3800341				CUMMINS
4026-AN	VA1401226	11341739820/ 822				BMW
4027-EPN	VE1400820	11341739821/ 823				BMW
4028-AN	VA0030331	13201-50K00				NISSAN
4028-AN	VA0030331	13201-50K00				NISSAN
4029-EPN	VE0031124	13202-50K02				NISSAN
4031-EPN	VE0140039	90323756	VX 2059 AA	VS-1984	50.017.791	GENERAL MOTORS
4032-AN	VA1950825	MD-085253				MITSUBISHI
4033-EPN	VE1950826	MD-085254				MITSUBISHI
4034-AN	VA0440572	97531079				CITROËN
4034-AN	VA0440572	97531079				PEUGEOT
4035-EPN	VE0440593	97531046				CITROËN
4035-EPN	VE0440593	97531046				PEUGEOT
4038-AN	VA0630240	13711-17010				TOYOTA
4039-EPN	VE0630241	13715-17010				TOYOTA
4041-ECB	VE0010212	99432837EC54-0652	VX 4014 AA			IVECO
4041-ECB	VE0010212	99432837EC54-0652	VX 4014 AA			PEUGEOT
4054-AC	VA0140226	93333561	VX 3176 AA			GENERAL MOTORS
4055-EC	VE0140248	93333562	VX 3177 AA			GENERAL MOTORS
4056-AC	VA0140040	90220119	VX 1699 AA	VS-1980	50.017.752	GENERAL MOTORS
4057-EX	VE0140039	90323756	VX 2059 AA	VS-1984	50.017.791	GENERAL MOTORS
4066-A	VA0510227	14711-KSS-9000	VX 3204 AA			HONDA
4067-ECB	VE0510228	14721-KSS-9000	VX 3242 AA			HONDA
4080-AN	VA0181483	7701472669				RENAULT
4081-EPN	VE0181484	7701472670				RENAULT
4092-ACB	VA0710203	1547492	VX 4017 AA	VS-5143	50.017.689	VOLVO
4094-AC	VA0011469	500355778			50.017.897	IVECO
4095-ECB	VE0011470	504293892			50.017.898	IVECO
4096-AC	VA0480193	5410500226		VS-5037		MERCEDES-BENZ
4097-ECB	VE0481437	A4570500327				MERCEDES-BENZ
4104-A	VA0701558	03L.109.601				VOLKSWAGEN
4105-EB	VE0701559	03L.109.611				VOLKSWAGEN
4109-ECB	VE0481487	9060500827				MERCEDES-BENZ
4109-ECB	VE0480245	9060500327				MERCEDES-BENZ
4112-AC	VA0011475	504069199				IVECO
4113-EC	VE0011616	504378070				IVECO
4134-A	VA0031570	13201-CP50A				NISSAN
4135-EN	VE0031605	13202-EN20B / 13202-0970R				NISSAN

3B	MAHLE	ORIGINAL	TRW	EATON	KS	LINHA MOTORA
4135-EN	VE0031605	13202-0970R / 13202-EN20B				RENAULT
4136-A	VA0031617 (VA0031506)	13201-AD210 (13201-5X00B)				NISSAN
4137-EN	VE0031618 (VE0031507)	13202-AD200 (13202-5X00B)				NISSAN
4154-AC	VA0251610	55224590				FIAT
4155-EN	VE0251611	55231699				FIAT
4156-AC	VA0251633	55219002				FIAT
4164-AN	VA0510263	14711-PWA-000			50.017.926	HONDA
4165-EN	VE0510264	14721-PWA-000			50.017.927	HONDA
4166-AN	VA5511554	14711-RC0-M00				HONDA
4167-EN	VE5511555	14721-RC0-M00				HONDA
4170-AN	VA2081301	22211-42220				HYUNDAI
4171-EN	VE2081302	22212-42220				HYUNDAI
4183-EN	VE0630208	13715-22030				TOYOTA
4184-AN	VA0180393	8200708663			50.017.935	RENAULT
4185-EN	VE0180310	8200708662			50.017.936	RENAULT
420-A	VA0210147	135957				CUMMINS
4218-AX	VA0711398	20740798				VOLVO
4219-EX	"VE0711695 (VE0711399)"	20768519 / 20768523 / 21016539				VOLVO
421-A	VA0181483	7701472669				RENAULT
422-A	VA0700050	040.109.601.1	VX 0435 AF	VS-868	50.017.715	VOLKSWAGEN
422-A	VA0700061	056.109.601.A	VX 0428 AF	VS-981	50.017.392	VOLKSWAGEN
422-AC	VA0700061	056.109.601.A	VX 0428 AF	VS-981	50.017.392	VOLKSWAGEN
4242-AX	VA0760103	1515743 / 1333230	VX 2750 AA		50.009.016	SCANIA
4243-EX	VE0760102	1328537	VX 2751 AA			SCANIA
4246-AC	VA0011467	504072531				IVECO
4247-EC	VE0011468	504081062				IVECO
4256-AC	VA0251633	55219002				FIAT
4257-EC	VE0251476	55218807			50.017.972	FIAT
4310-AN	VA1950236	ME-203101				MITSUBISHI
4311-EN	VE1950237	ME-203102				MITSUBISHI
4334-AN	VA0480233	6110530101				MERCEDES-BENZ
4335-EN	VE0480251	6110530005				MERCEDES-BENZ
4344-AN	VA0591471	1S4G-6507-CB				FORD
4345-EN	VE0591472	AM5G-6505-AB				FORD
452-A	VA0700020	040.109.601.2	VX 0434 AG	VS-869	50.017.716	VOLKSWAGEN
452-A	VA0700050	040.109.601.1	VX 0435 AF	VS-868	50.017.715	VOLKSWAGEN
453-A	VA0700020	040.109.601.2	VX 0434 AG	VS-869	50.017.716	VOLKSWAGEN
455-A	VA0720156					ASIA MOTORS
487-AC	VA0140183	10241743				GENERAL MOTORS
561-A	VA0110235	9L-7682				CATERPILLAR
565-AC	VA0130011	9.2260.460.0054	VX 0304 AA	VS-1134	50.017.717	FORD
565-AC	VA0130011	9.2260.460.0054	VX 0304 AA	VS-1134	50.017.717	MWM
573-A	VA0110143	5S-6452		VS-0969		CATERPILLAR
573-E	VE0110142	5S-6449		VS-968		CATERPILLAR
582-AC	VA0710121	468302	VX 1594 AA	VS-4937	50.017.124	VOLVO
814-AC	VA0590044	84AU-6507-B / 0291096011	VX 1321 AA	VS-1492	50.017.797	FORD
814-AC	VA0590044	84AU-6507-B / 0291096011	VX 1321 AA	VS-1492	50.017.797	VOLKSWAGEN
815-A	VA0700088	048.109.601.E	VX 2923 AA	VS-4510	50.004.599	VOLKSWAGEN
815-AC	VA0700017	035.109.601.C	VX 1368 AA	VS-1646	50.017.396	VOLKSWAGEN
816-AC	VA0590044	84AU-6507-B / 0291096011	VX 1321 AA	VS-1492	50.017.797	FORD
816-AC	VA0590044	84AU-6507-B / 0291096011	VX 1321 AA	VS-1492	50.017.797	VOLKSWAGEN
825-A	VA0700078	049.109.601.F	VX 1202 AA	VS-1356	50.017.385	VOLKSWAGEN

3B	MAHLE	ORIGINAL	TRW	EATON	KS	LINHA MOTORA
843-AC	VA0480080	3450537001	VX 1565 AA	VS-1129	50.017.757	MERCEDES-BENZ
843-AC	VA0480091	3550530001	VX 0846 AA	VS-1136	50.017.119	MERCEDES-BENZ
843-AC C/O	VA0480091	3550530001	VX 0846 AA	VS-1136	50.017.119	MERCEDES-BENZ
843-AC+0,4	VA0480080+04					MERCEDES-BENZ
843-AC+0,8	VA0480080+08					MERCEDES-BENZ
855-AC	VA0250054	7617500	VX 2399 AA	VS-2692	50.017.720	FIAT
856-AC	VA0250054	7617500	VX 2399 AA	VS-2692	50.017.720	FIAT
860-AC	VA0710063	469240 / 4675002 / 8194223	VX 0588 AB	VS-4934	50.017.126	VOLVO
860-AC C/O	VA0710063	469240 / 4675002 / 8194223	VX 0588 AB	VS-4934	50.017.126	VOLVO



Guias de Válvulas

As guias de válvulas MAHLE Original e Metal Leve são projetadas e fabricadas em diferentes formas, utilizando-se materiais e tecnologias de ponta, de modo a proporcionar o máximo de desempenho e durabilidade. As peças são fabricadas em ferro fundido ligado, podendo receber tratamento superficial, por exemplo, de fosfatização.

Materiais otimizados para aplicações específicas podem ser selecionados, levando-se em consideração os aspectos de usinabilidade e compatibilidade tribológicas das superfícies de contato.

As guias de válvulas de bronze atendem tanto o mercado de reposição quanto o de motores de competição por possuírem uma condutividade de calor diferenciada e pela sua resistência ao desgaste por atrito, especialmente para motores a GNC/GLP, nos quais as condições de lubrificação são reduzidas e as cargas térmicas, maiores.

Tipos e termos técnicos

GA -Guias de Válvulas de Admissão

GE -Guias de Válvulas de Escape

GC -Guias de Válvulas Comum (Admissão e Escape)

Para facilitar a identificação em caso de dúvidas, foram esquematizados e indicados por letras (A, B, C, etc.).

As características particulares são assinaladas com números de 1 a 8.

1) Ranhura externa para o assento do anel de fixação.

2) Rebaixo.

3) Extremidade cônica.

4) Câmara interna.

5) Furo para lubrificação.

6) Câmara Interna na extremidade da guia.

7) Canal para lubrificação.

8) Canal para lubrificação.

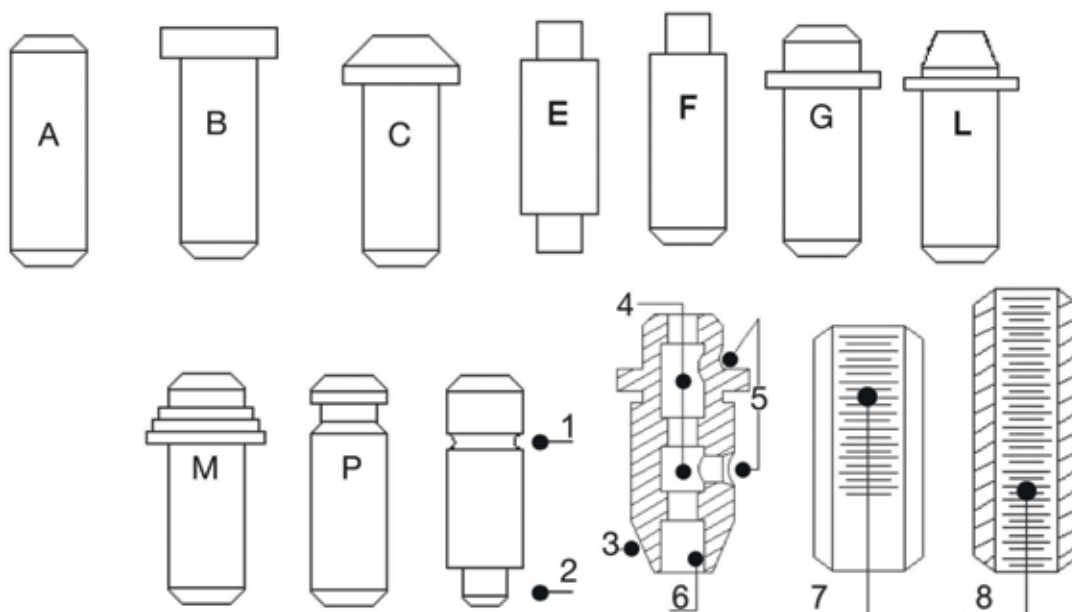

Função

- Suportar os esforços de fricção lateral que geram o movimento alternativo das válvulas.
- Dissipar o calor das hastes das válvulas.
- Manter o alinhamento correto do conjunto (válvula, assento e guia) para selar corretamente a câmara de combustão.

Características indicadas na coluna de medidas:

D) diâmetro externo;

d) diâmetro interno;

L) comprimento.

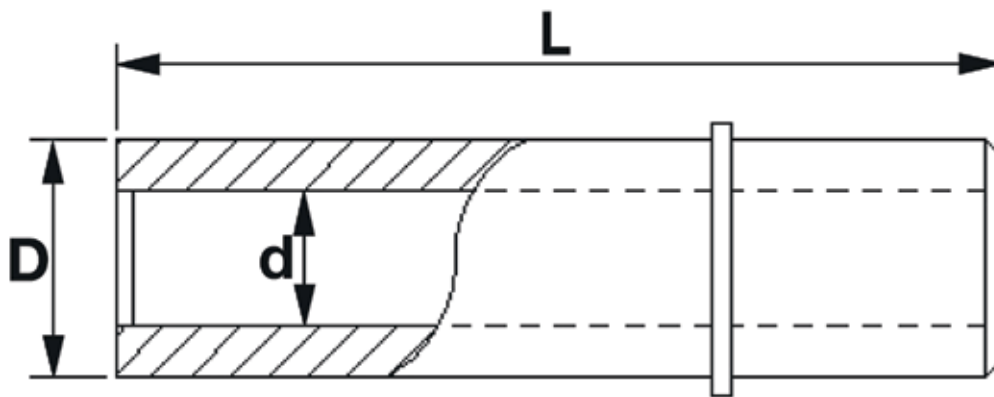

Estrutura da página e decodificação dos códigos das peças

1 MERCEDES-BENZ						MAHLE		
2	3	4	5	6	7	8	9	
								D x d x L
Mot. OM 447 LA/449 LA Motor Maxion Sprinter 2.5l.	5/6	IN - EX	GC0480030	STD	18,04 x 12,00 x 67,00	FG	A-2	
	4	IN - EX	GC0570056	STD	14,05 x 8,01 x 49,00	FG	F	
Motor OM 321 L1112-LS1112-LO1112	6	IN	GA0480007	STD	15,04 x 9,00 x 78,00	FG	A-3	
Motor OM 352, OM 352A, OM 314 Con Câmara Interior	6	IN	GA0480007	STD	15,04 x 9,00 x 78,00	FG	A-3	
Motor OM 352, OM 352A, OM 314-1114 (mod.'84 en ad.)	6	EX	GE0480026	STD	15,04 x 10,00 x 67,00	FG	A	
Motor OM 352, OM 352A, OM 314A/ Turbo L508D-L608D-L1113-L1114- L1413-LK1517	6	IN	GA0480007	STD	15,04 x 9,00 x 78,00	FG	A-3	
		EX	GE0480031	STD	15,03 x 10,00 x 73,00	FG	A	
Motor OM 355 L1521-L1526, OM 346, OM 355 Turbo	5/6	IN	GA0480013	STD	15,04 x 9,01 x 67,50	FG	A-1	
		EX	GE0480014	STD	15,04 x 9,01 x 86,50	FG	A-1	
Motor OM 366, OM 366 Turbo	6	IN	GA0480033	STD	15,04 x 9,00 x 72,00	FG	A-1	
		EX	GE0480035	STD	15,04 x 10,00 x 67,00	FG	A-1	
Motor OM 447, OM 449 1633	6	IN - EX	GC0480030	STD	18,04 x 12,00 x 67,00	FG	A-2	
Motor OM 457 LA	6	IN - EX	GC0480053	STD	15,04 x 9,00 x 61,10	FG	F-1	
Motor OM 904LA 12v., OM 906LA 712, 1721 18v.	4/6	IN - EX	GC0480068	STD	14,04 x 8,00 x 60,00	FG	P	
Motores OM 352 e 321	6	IN	GA0480007	STD	15,04 x 9,00 x 78,00	FG	A-3	
Motores OM 352A c/ quebra carvão- Mercedes Benz	6	EX	GE0480044	STD	15,04 x 10,01 x 67,00	-	A-6	
Motores OM 366, OM 352A- Mercedes Benz	6	IN	GA0480001	STD	15,03 x 9,01 x 72,00	-	A-1	
		EX	GE0480002	STD	15,03 x 10,01 x 67,00	-		

1 Fabricante

2 Nome do motor

Dados do motor

Veículos

Ano de fabricação

3 Número do cilindro

4 Função

IN = Admissão

EX = Escape

IN - EX = Comum

5 Número de artigo da sede de válvula

Ex.: GA 048 0002

— Número sequencial

— Linha motora

GA - Guia de válvula de admissão

GE - Guia de válvula de escape

GC - Guias de válvulas comum (admissão e escape)

6 Medidas

7 Dimensões

8 Material

9 Forma

Valve Guides

MAHLE Original and Metal Leve valve guides are designed and manufactured in different shapes, using state-of-the-art materials and technologies to provide maximum performance and durability. Parts are manufactured cast iron alloy and could receive surface treatment, like phosphatization.

Materials are optimized for specific applications and are selected according to machinability and compatibility aspects, contact surface tribology.

Bronze valve guides meet the needs of both the replacement market and racing engines, as they have different thermal heat conductivity and because they can withstand the friction wear, especially for GNC/GLP engines, where lubricating conditions are reduced and thermal loads are higher.

Types and technical words

GA - Intake Valves Guides

GE - Exhaust Valves Guides

GC - Common valve guide (Intake and Exhaust) To help identification if there are any doubts, they have been outlined and indicated by alphabet letters (A, B, C, etc.).

Specific characteristics are highlighted with numbers 1 to 8.

1) External soot for the site of fixed ring.

2) Rebate.

3) Conical extremity.

4) Internal camera.

5) Lubricant hole.

6) Internal camera at the guide extreme.

7) Lubricating fillet.

8) Lubricating fillet.

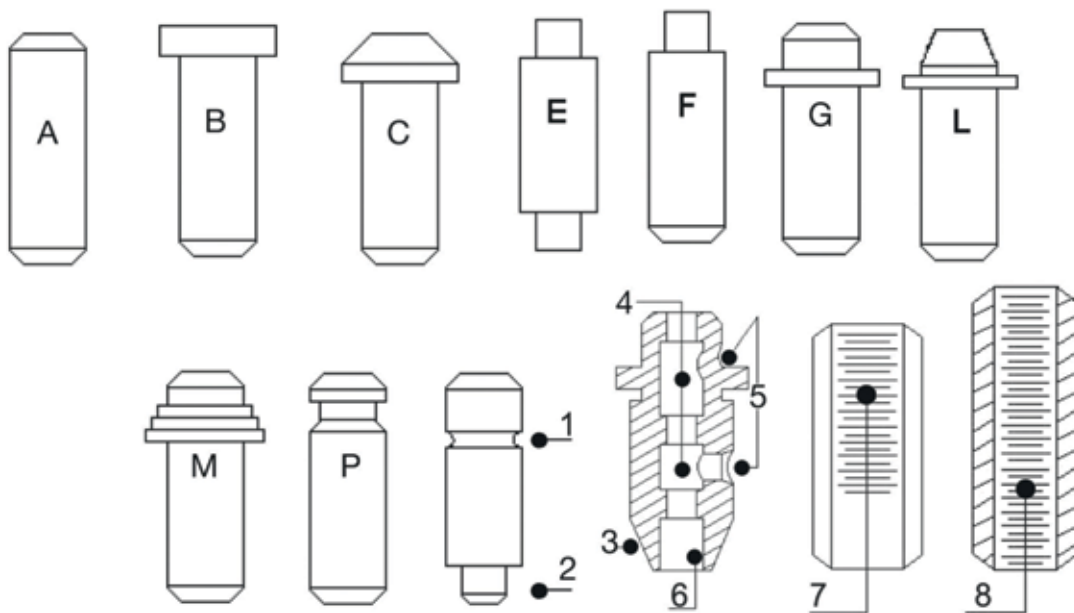

Purpose

- Support lateral friction forces that generate alternative movements of the valves.
- Dissipate heat from valve shafts.
- Keep the appropriate alignment of the assembly (valve, seat and guide) to appropriately seal the combustion chamber.

Characteristics described in the dimensions column

D) Outside Diameter

d) Inside Diameter

L) Length

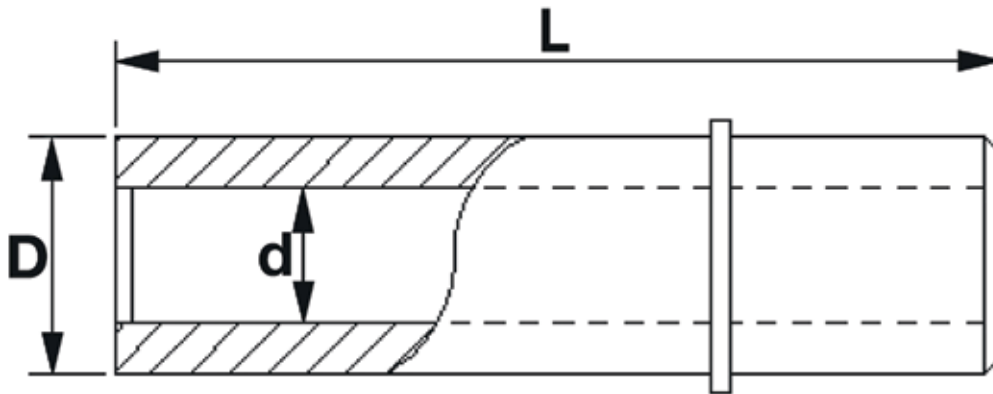

Page structure and part code decoding

1 MERCEDES-BENZ						MAHLE		
2	3	4	5	6	7	8	9	
								Nº CIL.
Mot. OM 447 LA/449 LA Motor Maxion Sprinter 2.5l.	5/6	IN - EX	GC0480030	STD	18,04 x 12,00 x 67,00	FG	A-2	
	4	IN - EX	GC0570056	STD	14,05 x 8,01 x 49,00	FG	F	
Motor OM 321 L1112-LS1112-LO1112	6	IN	GA0480007	STD	15,04 x 9,00 x 78,00	FG	A-3	
Motor OM 352, OM 352A, OM 314 Con Cámara Interior	6	IN	GA0480007	STD	15,04 x 9,00 x 78,00	FG	A-3	
Motor OM 352, OM 352A, OM 314-1114 (mod.'84 en ad.)	6	EX	GE0480026	STD	15,04 x 10,00 x 67,00	FG	A	
Motor OM 352, OM 352A, OM 314A/ Turbo L508D-L608D-L1113-L1114-L1413-LK1517	6	IN	GA0480007	STD	15,04 x 9,00 x 78,00	FG	A-3	
		EX	GE0480031	STD	15,03 x 10,00 x 73,00	FG	A	
Motor OM 355 L1521-L1526, OM 346, OM 355 Turbo	5/6	IN	GA0480013	STD	15,04 x 9,01 x 67,50	FG	A-1	
		EX	GE0480014	STD	15,04 x 9,01 x 86,50	FG	A-1	
Motor OM 366, OM 366 Turbo	6	IN	GA0480033	STD	15,04 x 9,00 x 72,00	FG	A-1	
				0,05	15,09 x 9,00 x 72,00	FG	A-2	
		EX	GE0480035	STD	15,04 x 10,00 x 67,00	FG	A-1	
				0,05	15,09 x 10,00 x 67,00			
Motor OM 447, OM 449 1633	6	IN - EX	GC0480030	STD	18,04 x 12,00 x 67,00	FG	A-2	
Motor OM 457 LA	6	IN - EX	GC0480053	STD	15,04 x 9,00 x 61,10	FG	F-1	
Motor OM 904LA 12v., OM 906LA 712, 1721 18v.	4/6	IN - EX	GC0480068	STD	14,04 x 8,00 x 60,00	FG	P	
Motores OM 352 e 321	6	IN	GA0480007	STD	15,04 x 9,00 x 78,00	FG	A-3	
Motores OM 352A c/ quebra carvão-Mercedes Benz	6	EX	GE0480044	STD	15,04 x 10,01 x 67,00	-	A-6	
Motores OM 366, OM 352A- Mercedes Benz	6	IN	GA0480001	STD	15,03 x 9,01 x 72,00	-	A-1	
		EX	GE0480002	STD	15,03 x 10,01 x 67,00	-		

- 1 Manufacturer
- 2 Engine Name
Engine Data
Vehicles
Manufacturing Year
- 3 Cylinder number
- 4 Function
IN = Intake
EX = Exhaust
IN - EX = Common

- 5 Valve Seat Product Number
Ex.: GA 048 0002
 - Sequence Number
 - Engine Line
 - GA - Intake valve guide
 - GE - Exhaust valve guide
 - GC - Common valve guide (Intake and Exhaust)

- 6 Size
- 7 Dimensions
- 8 Material
- 9 Shape

Guías de Válvulas

Las guías de válvulas MAHLE Original y Metal Leve son proyectadas y fabricadas en formas distintas, utilizando materiales y tecnologías de punta, para garantizar el máximo desempeño y durabilidad. Las piezas son fabricadas en hierro fundido con aleaciones, pudiendo recibir tratamiento superficial, por ejemplo de fosfatización.

Materiales optimizados para aplicaciones específicas pueden ser seleccionados, considerando los aspectos de torneabilidad y compatibilidad tribológica de las superficies de contacto.

Las guías de válvulas de bronce atienden tanto el mercado de reposición cuanto los motores de competición, porque poseen una conductividad de calor diferenciada y por su resistencia al desgaste por fricción, especialmente para motores que usan GNC/GLP como combustible, donde las condiciones de lubricación son reducidas y las cargas térmicas mayores.

Tipos y conceptos técnicos

GA - Guías de Válvulas de Admisión

GE - Guías de Válvulas de Escape

GC - Guías de Válvulas Común (Admisión y Escape)

Para facilitar la identificación en los casos de dudas, hemos pensado en esquematizar la forma de la guía, dando por símbolo una letra (A, B, C, etc.).

Lo procedente es orientativo a la forma de la guía. Las características particulares son señaladas con cifras que van de 1 al 8.

1) Ranura exterior para el asiento del anillo de fijación.

2) Rebaje.

3) Extremidad Cónica.

4) Cámara Interna.

5) Agujero para Lubricación.

6) Cámara Interna en el extremo de la Guía.

7) Filete para Lubricación.

8) Filete para Lubricación.

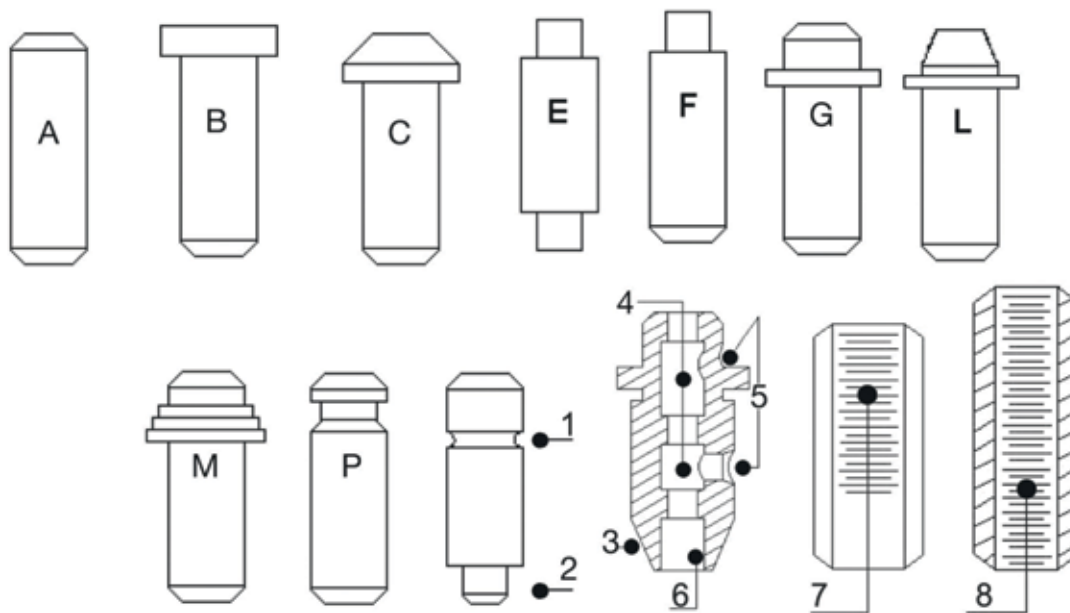

Función

- Soportar los esfuerzos de fricción lateral generados en el movimiento alternativo de las válvulas.
- Disipar el calor de los vástagos de las válvulas.
- Mantener el alineamiento correcto del conjunto (válvula, asiento y guía) para hermetizar correctamente la cámara de combustión.

Características indicadas en la columna de medidas

D) Diámetro exterior

d) Diámetro interior

L) Largo total

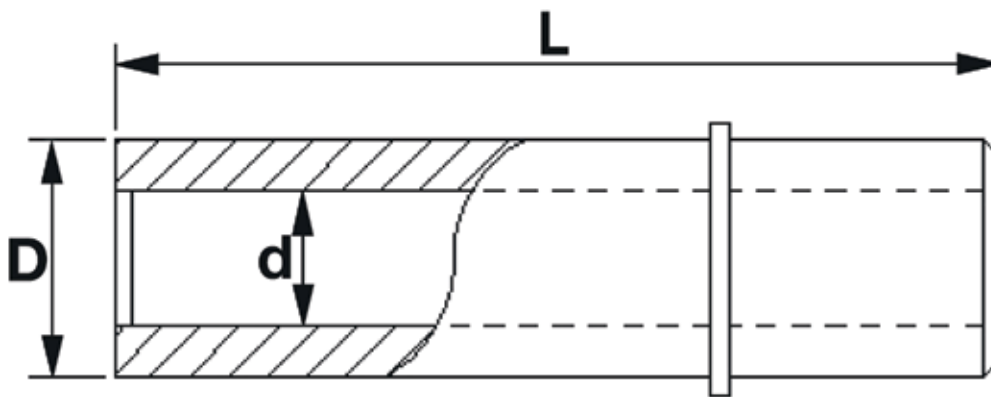

Configuración de las páginas y códigos de artículos

1 MERCEDES-BENZ						MAHLE		
2	Nº CIL. 3	TIPO TYPE 4	CÓD. MAHLE / METAL LEVE 5	MEDIDA 6	7		MATERIAL 8	FORMA 9
					D x d x L			
Mot. OM 447 LA/449 LA Motor Maxion Sprinter 2.5l.	5/6	IN - EX	GC0480030	STD	18,04 x 12,00 x 67,00		FG	A-2
	4	IN - EX	GC0570056	STD	14,05 x 8,01 x 49,00		FG	F
Motor OM 321 L1112-LS1112-LO1112	6	IN	GA0480007	STD	14,15 x 8,01 x 49,00		FG	A-3
Motor OM 352, OM 352A, OM 314 Con Cámara Interior	6	IN	GA0480007	STD	15,04 x 9,00 x 78,00		FG	A-3
Motor OM 352, OM 352A, OM 314-1114 (mod.'84 en ad.)	6	EX	GE0480026	STD	15,04 x 10,00 x 67,00		FG	A
Motor OM 352, OM 352A, OM 314A/ Turbo L508D-L608D-L1113-L1114-L1413-LK1517	6	IN	GA0480007	STD	15,04 x 9,00 x 78,00		FG	A-3
		EX	GE0480031	STD	15,03 x 10,00 x 73,00		FG	A
Motor OM 355 L1521-L1526, OM 346, OM 355 Turbo	5/6	IN	GA0480013	STD	15,04 x 9,01 x 67,50		FG	A-1
		EX	GE0480014	STD	15,04 x 9,01 x 86,50		FG	A-1
Motor OM 366, OM 366 Turbo	6	IN	GA0480033	STD	15,04 x 9,00 x 72,00		FG	A-1
		EX	GE0480035	STD	15,04 x 10,00 x 67,00		FG	A-1
Motor OM 447, OM 449 1633	6	IN - EX	GC0480030	STD	18,04 x 12,00 x 67,00		FG	A-2
Motor OM 457 LA	6	IN - EX	GC0480053	STD	15,04 x 9,00 x 61,10		FG	F-1
Motor OM 904LA 12v., OM 906LA 712, 1721 18v.	4/6	IN - EX	GC0480068	STD	14,04 x 8,00 x 60,00		FG	P
Motores OM 352 e 321	6	IN	GA0480007	STD	15,04 x 9,00 x 78,00		FG	A-3
Motores OM 352A c/ quebra carvão-Mercedes Benz	6	EX	GE0480044	STD	15,04 x 10,01 x 67,00		-	A-6
Motores OM 366, OM 352A- Mercedes Benz	6	IN	GA0480001	STD	15,03 x 9,01 x 72,00		-	A-1
		EX	GE0480002	STD	15,03 x 10,01 x 67,00		-	

español

- 1 Fabricante
- 2 Descripción del motor
Datos del Motor
Vehículos
Año de Fabricación
- 3 Número de cilindros
- 4 Función
IN = Admisión
EX = Escape
IN - EX = Común

- 5 Número de Artículo de la Guía de Válvula
Ex.: GA 048 0002
 - Número Secuencial
 - Línea Motora
 - GA - Guía de válvula de admisión
 - GE - Guía de válvula de escape
 - GC - Guías de válvulas común (admisión y escape)

- 6 Medidas
- 7 Dimensiones
- 8 Material
- 9 Forma

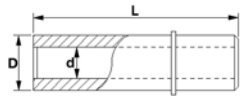
	Nº CIL.	TIPO TYPE	CÓD. MAHLE / METAL LEVE	MEDIDA		MATERIAL	FORMA
					D x d x L		
Motor M80 / M85 / M90 Mod. Lisa	-	IN - EX	GC0060431*	STD 1	12.05 x 8.01 x 60.00	B	A

(*) Item sob consulta

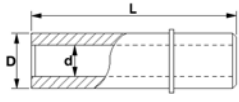
	N° CIL.	TIPO TYPE	CÓD. MAHLE / METAL LEVE	MEDIDA		MATERIAL	FORMA
					D x d x L		
Motor 800cc - Towner - Gasolina	3	IN - EX	GC0720046	STD	12.05 x 7.01 x 50.00	FG	A
Motor 2.4 / 2.7 - Topic - Diesel	4	IN - EX	GC0720045	STD	12.75 x 8.01 x 54.00	FG	P

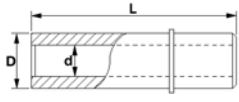
	Nº CIL.	TIPO TYPE	CÓD. MAHLE / METAL LEVE	MEDIDA		MATERIAL	FORMA
					D x d x L		
D330C, D333C, 3304 - Modelo 977, 966 D4D/D5 / 3306, 1673 12v, 1673C / 3306NA (Com pré-câmara) - D6C, D7E / 3304NA (Com pré-câmara) - D4D, D5 / 3306TC (Com pré-câmara) - D6C, D7E / 3304NA Injeção Direta / 3306TC Injeção Direta - D6D, D6E, D6E SR, D5E (Turbo Opcional), 330,330L, 140G	4/6	IN - EX	GC0110011	STD	16.70 x 9.47 x 71.45	FG	A-8

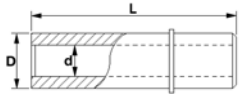
	Nº CIL.	TIPO TYPE	CÓD. MAHLE / METAL LEVE	MEDIDA		MATERIAL	FORMA
					D x d x L		
Motor B / BT - Ford F250, F350, F4000, VW 12170, 13170, 15170 - Parede Fina	4/6	IN - EX	GC0210054	STD	11.16 x 8.03 x 61.00	FG	A-7
Motor C / CT / CTA / CTAA - VW 14220, 17220, 24220, 26300, 17300, 40300, 25250, Ford 2630, 4030, 2425, 1622, 2422	6	IN - EX	GC0210023	STD	16.00 x 9.55 x 72.00	FG	A-11
Motor ISC 8.3 24v	6	IN - EX	GC0210432*	STD	14.00 x 8.02 x 49.50	FG	A

(*) Item sob consulta

	Nº CIL.	TIPO TYPE	CÓD. MAHLE / METAL LEVE	MEDIDA		MATERIAL	FORMA
					D x d x L		
Motor 1.0 / 1.3 / 1.5 - 8v Nacional	4	IN - EX	GC0250019	STD	15.06 x 8.02 x 46.50	FG	F-1
Motor 1.0 / 1.3 - 8v Nacional - Especial em Bronze	4	IN - EX	GC0250091	STD	15.06 x 8.02 x 46.50	B	F
Motor 1.0 8v Fire / 1.3 8v Fire - Gasolina / Flex	4	IN - EX	GC0250096	STD	13.02 x 7.03 x 40.20	FG	F
Motor 1.0 16v Fire / 1.3 16v Fire - Gasolina	4	IN - EX	GC0250097	STD	10.02 x 6.03 x 39.80	FG	F-1
Motor 1.4 8v - Fire	4	IN - EX	GC0250433*	STD	10.04 x 5.00 x 44.00	FG	F-1
Motor 1.5 8v Sevel Argentino / 1.6 8v Sevel Argentino	4	IN - EX	GC0250028	STD	14.05 x 8.02 x 46.70	FG	F-1-3
Motor 1.6 16v - Marea	4	EX	GE0250059	STD	13.04 x 7.00 x 45.80	FG	F-1
Motor 1.6 16v - Palio, Brava / Marea (Admissão)	4	IN - EX	GC0250055	STD	13.02 x 7.02 x 42.00	FG	F-1
Motor 1.6 16v - Palio - Especial em Bronze	4	IN - EX	GC0250100	STD	13.02 x 7.03 x 42.00	B	N
Motor 2.0 8v - Tempra	4	IN - EX	GC0250040	STD	14.08 x 7.99 x 42.00	FG	F
Motor 2.0 16v - Tempra	4	IN - EX	GC0250039	STD	14.04 x 7.00 x 51.00	FG	F-3
Motor 2.5 / 2.8 - Ducato, Daily	4	IN - EX	GC0010069	STD	13.04 x 7.99 x 56.00	FG	F
				0,05*	13.09 x 7.99 x 56.00	FG	F
				0,10*	13.14 x 7.99 x 56.00	FG	F
				0,20*	13.24 x 7.99 x 56.00	FG	F

(*) Item sob consulta

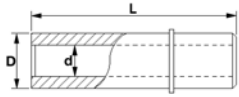
	Nº CIL.	TIPO TYPE	CÓD. MAHLE / METAL LEVE	MEDIDA		MATERIAL	FORMA
					D x d x L		
Motor 1.0 8v Zetec Rocan / 1.6 8v Zetec Rocan - Fiesta, Ká, Escort, Focus - Gasolina / Flex	4	IN - EX	GC0590066	STD	11.04 x 6.00 x 42.00	FG	A-3-3
Motor 1.4 / 1.6 - Corcel - 1969->	4	IN - EX	GC0590010	STD	11.15 x 6.97 x 41.50	FG	A-3
Motor 1.4 16v Zetec / Motor 1.8 16v Zetec / Motor 2.0 16v Zetec - Focus, Escort, Fiesta - Gasolina	4	IN - EX	GC0590060	STD	12.01 x 6.00 x 36.00	FG	A-3-3
Motor CHT - Corcel, Escort, Del Rey - Até Set/1991	4	IN - EX	GC0590020	STD	11.12 x 7.00 x 49.00	FG	F
Motor 3.0 16v NGD - Ranger Eletrônica	4	IN - EX	GC0590435*	STD	12.05 x 6.00 x 43.00	FG	A
Motor 4600 e 6600 - Ford Cargo, Tractor Ford	4/6	IN - EX	GC0260032	STD	16.05 x 9.47 x 72.00	FG	A

(*) Item sob consulta

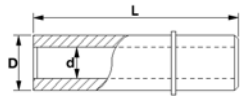
	Nº CIL.	TIPO TYPE	CÓD. MAHLE / METAL LEVE	MEDIDA		MATERIAL	FORMA
					D x d x L		
Motor 2.6 / 3.0 - 6cil - Jeep Willys	6	IN	GA0230434*	STD	16.71 x 9.54 x 61.00	FG	F
Motor B9, B9 C, NB 10, NB10C, NT 85	1	IN - EX	GC2310012	STD	14.03 x 9.01 x 56.90	FG	G-6
NSB 90, NSB 11	1	IN - EX	GC2310021	STD	13.04 x 8.01 x 47.50	FG	G-6
Motor 6cil - Jeep Willys	6	EX	GE0230006	STD	16.71 x 8.71 x 63.50	FG	F-6

(*) Item sob consulta

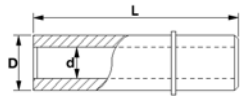
	Nº CIL.	TIPO TYPE	CÓD. MAHLE / METAL LEVE	MEDIDA		MATERIAL	FORMA
					D x d x L		
Motor 1.0 8v EFI / MPFI / 1.4 8v EFI / 1.6 8v EFI / MPFI - Corsa / Motor 1.0 8v VHC - Corsa / Motor 1.6 / 1.8 - Fase 2 - Monza, Kadett / Motor 2.0 8v Nacional - Kadett, Vectra, Monza / Motor 2.2 8v Omega, Vectra / Motor 2.4 8v - S10, Blazer	4	IN - EX	GC0140029	STD	11.03 x 7.02 x 46.00	FG	A-1
				0,05	11.08 x 7.02 x 46.00	FG	A-1
Motor 1.0 8v EFI / MPFI / 1.4 8v EFI / 1.6 8v EFI / MPFI - Corsa / Motor 1.0 8v VHC - Corsa / Motor 1.6 / 1.8 - Fase 2 - Monza, Kadett / Motor 2.0 8v Nacional - Kadett, Vectra, Monza / Motor 2.2 8v Omega, Vectra / Motor 2.4 8v - S10, Blazer - Especial em Bronze	4	IN - EX	GC0140092	STD 1	11.03 x 7.02 x 46.00	B	A-1
Motor 1.0 16v / 1.6 16v - Corsa / Motor 1.4 Econoflex - Corsa, Agile / Motor 1.4 - Onix - 2012-> - Flex / Motor 1.8 16v - Meriva - Gasolina / Motor 1.8 8v - Meriva - Flex / Motor 2.0 16v / 2.2 16v - Astra, Vectra	4	IN	GA0140047	STD	10.04 x 6.00 x 45.00	FG	F
				0,10	10.14 x 6.00 x 45.00	FG	F
Motor 1.6 / 1.8 Fase 1 - Monza, Kadett	4	IN - EX	GC0140027	STD	12.03 x 7.99 x 43.00	FG	A-1
Motor 261 - C10 - Gasolina	6	IN	GA0140003	STD	14.34 x 8.70 x 85.00	FG	A-2
		EX	GE0140004	STD	14.34 x 8.70 x 85.00	FG	A
Motor S4 / P4001 / ST7 (GM) / S4T / P4000 / P4000T	4	IN - EX	GC0570043	STD	15.91 x 9.54 x 55.00	FG	F

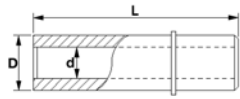
	Nº CIL.	TIPO TYPE	CÓD. MAHLE / METAL LEVE	MEDIDA		MATERIAL	FORMA
					D x d x L		
Motor 125cc - Motocicleta CG, ML, Cargo, Today, Turuna - Até 1991	1	EX	GE0510022	STD	11.10 x 5.47 x 42.00	FG	M
Motor 125cc - Motocicleta Titan CDI, XLR - 1991->	1	IN - EX	GC0510058	STD	11.10 x 5.48 x 46.50	FG	M
Motor 125cc - Motocicleta - 2002->	1	EX	GE0510098	STD	10.09 x 5.02 x 46.50	FG	G
Motor 150cc - Motocicleta CG Titan (KS, ES, ESD), NXR Bros (KS, ES, ED)	1	IN - EX	GC0510099	STD	10.09 x 5.00 x 39.40	FG	M
Motor 1.6 16v D16B6 / D16A/Z - Civic - Gasolina	4	IN	GA0510436*	STD	11.07 x 5.54 x 47.50	FG	A-1-1-2
	4	EX	GE0510437*	STD	11.07 x 5.54 x 54.10	FG	A-1-1-2

(*) Item sob consulta

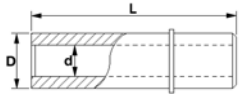
	Nº CIL.	TIPO TYPE	CÓD. MAHLE / METAL LEVE	MEDIDA		MATERIAL	FORMA
					D x d x L		
Motor 2.4 - H100	4	IN - EX	GC2080050	STD	13.07 x 8.00 x 74.00	FG	A-1

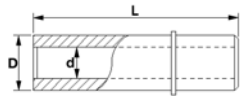
	N° CIL.	TIPO TYPE	CÓD. MAHLE / METAL LEVE	MEDIDA		MATERIAL	FORMA
					D x d x L		
Motor 2.5 / 2.8 - Ducato, Daily	4	IN - EX	GC0010069	STD	13.04 x 7.99 x 56.00	FG	F
				0,05*	13.09 x 7.99 x 56.00	FG	F
				0,10*	13.14 x 7.99 x 56.00	FG	F
				0,20*	13.24 x 7.99 x 56.00	FG	F

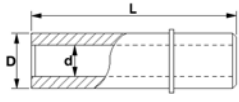
	Nº CIL.	TIPO TYPE	CÓD. MAHLE / METAL LEVE	MEDIDA		MATERIAL	FORMA
					D x d x L		
Motor 2.5 HS / 2.8 HS - Ford Ranger, Land Rover Defender / Motor OM014A - Sprinter, S10, F1000	4	IN - EX	GC0570056	STD	14.05 x 8.01 x 49.00	FG	F
				0,10	14.15 x 8.01 x 49.00		
Motor OM314 / OM352 / OM352A - L508D, L608D, L1113, L1114, L1413, LK1517	6	IN	GA0480007	STD	15.04 x 9.00 x 78.00	FG	A-3
		EX	GE0480031	STD	15.03 x 10.00 x 73.00		FG
Motor OM314 / OM321 / OM352 / OM352A - Com Câmara Interna	6	IN	GA0480007	STD	15.04 x 8.98 x 78.00	FG	A-3
Motor OM346 / OM355 / OM355A	5/6	IN	GA0480013	STD	15.04 x 9.01 x 67.50	FG	A-1
		EX	GE0480014	STD	15.04 x 9.01 x 86.50		
Motor OM352A	6	EX	GE0480026	STD	15.04 x 10.00 x 67.00	FG	A
Motor OM352A (Com Quebra Carvão)	6	EX	GE0480044	STD	15.04 x 10.01 x 67.00	FG	A-6
Motor OM352A / OM364/A/LA / OM366/A/LA	6	IN	GA0480033	STD	15.04 x 9.00 x 72.00	FG	A-1
				0,05	15.09 x 9.00 x 72.00		FG
		EX	GE0480035	STD	15.04 x 10.00 x 67.00	FG	A-1
				0,05	15.09 x 10.00 x 67.00		
Motor OM352A / OM364/A/LA / OM366/A/LA	6	IN	GA0480001	STD	15.04 x 9.01 x 68.00	FG	A-1
		EX	GE0480002	STD	15.04 x 10.01 x 63.00		
Motor OM447 / OM447LA / OM449 / OM449LA	5/6	IN - EX	GC0480030	STD	18.04 x 12.00 x 67.00	FG	A-2
Motor OM457LA Até Euro 5	6	IN - EX	GC0480053	STD	15.04 x 9.00 x 61.10	FG	F-1
Motor OM611LA - Sprinter 311 / Motor OM612LA - Accelo	4/5	IN - EX	GC0480439*	STD	12.56 x 7.01 x 37.50	FG	N
Motor OM904A / OM904LA / OM906LA / OM924LA / OM926LA - Até Euro 3	4/6	IN - EX	GC0480068	STD	14.04 x 8.00 x 60.00	FG	P

(*) Item sob consulta

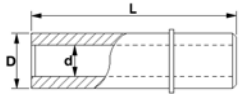
	Nº CIL.	TIPO TYPE	CÓD. MAHLE / METAL LEVE	MEDIDA		MATERIAL	FORMA
					D x d x L		
Motor 2.8 - L200, Pajero - Diesel	4	EX	GE1950440*	STD	13.07 x 8.00 x 51.00	FG	A-3-6

(*) Item sob consulta

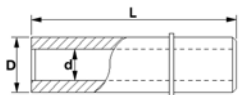
	Nº CIL.	TIPO TYPE	CÓD. MAHLE / METAL LEVE	MEDIDA		MATERIAL	FORMA
					D x d x L		
Motor D225 / D226 / D229 - Agrale 7500D, Fiat Tractor-Esteira FD6, Pá-Carregadeira, Tractor Valmet	3/4/6	IN - EX	GC0130008	STD	15.04 x 9.01 x 58.00	FG	G
Motor D225 / D226 - Para uso com retentor	3/4/6	IN - EX	GC0130041	STD	15.03 x 9.01 x 53.50	FG	N
Motor D225 / D226 - Sem anel	3/4/6	IN - EX	GC0130037	STD	15.03 x 9.01 x 58.00	FG	A-1
Motor 4.07TCA / 4.07TCE / 6.07T / 6.07TCA - Sprint - GM Silverado, F250, Caminhões 3500 HD, GM S10, VW LT2, Agrale Volare, Jipe Troller, Nissan, Frontier, Xterra	4/6	IN - EX	GC0130063	STD	12.03 x 7.01 x 40.55	FG	N
Motor 4.10 / 4.10T / 6.10 / 6.10T / 6.10TCA / 6.10TCW - VW 14150, 16210CO, 15180, 13180, 17180, 17210, 17240, 17290, F1000, Ônibus 180A e 210LA, Grupo Gerador 50 Hz, 60/80 Hz	4/6	IN - EX	GC0130042	STD	15.04 x 9.00 x 49.00	FG	N
Motor KD112 / D222 - Tratores Fendt e Valmet Brasileiro	-	IN - EX	GC0130441*	STD	16.05 x 10.02 x 64.00	FG	C

(*) Item sob consulta

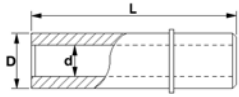
	Nº CIL.	TIPO TYPE	CÓD. MAHLE / METAL LEVE	MEDIDA		MATERIAL	FORMA
					D x d x L		
Motor 4236 / T4236 / Q20B4236 / TQ20B4236 / 4248 / Q20B4236 / TQ20B4236	4/6	IN	GA0570017	STD	15.93 x 9.50 x 58.00	FG	F
		EX	GE0570018	STD	15.93 x 9.51 x 61.10	FG	F-6
Motor 3152 / D3152 / 4203 / D4203	3/4	IN - EX	GC0570005	STD	12.74 x 7.98 x 61.90	FG	A-6
Motor 6357 - Veicular / Industrial	6	IN - EX	GC0570009	STD	15.93 x 9.51 x 68.00	FG	L
Motor 6358	6	IN - EX	GC0570015	STD	15.93 x 9.50 x 66.00	FG	F
Adaptação D10	6	IN - EX	GC0570016	STD	15.91 x 9.54 x 52.70	FG	F
Motor S4 / P4001 / ST7 (GM) / S4T / P4000 / P4000T	4	IN - EX	GC0570043	STD	15.91 x 9.54 x 55.00	FG	F
Motor 2.5 HS / 2.8 HS - Ford Ranger, Land Rover Defender / Motor OM014A - Sprinter, S10, F1000	4	IN - EX	GC0570056	STD	14.05 x 8.01 x 49.00	FG	F
				0,10	14.15 x 8.01 x 49.00		

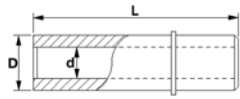
	Nº CIL.	TIPO TYPE	CÓD. MAHLE / METAL LEVE	MEDIDA		MATERIAL	FORMA
					D x d x L		
Motor 1.0 16v D4D - Clio / Motor 1.6 16v K4M - Megane / Motor 2.0 16v F4R - Scenic	4	IN - EX	GC0180442*	STD 1	11.07 x 5.50 x 40.50	B	A
Motor 2.0 GXE / 2.2 GXE - Trafic	4	IN - EX	GC0180062	STD	13.06 x 8.00 x 50.00	FG	F

(*) Item sob consulta

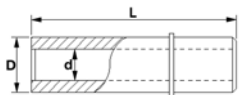
	Nº CIL.	TIPO TYPE	CÓD. MAHLE / METAL LEVE	MEDIDA		MATERIAL	FORMA
					D x d x L		
Motor DC9 5cil Euro 5 - 250cv, 270cv, 310cv / Motor D11 / DC11 / D12 / DN12 / DS12 / DSC12 - 114, 124 / Motor DC12 Série 4 / DC12 Série 4 Evolution 5 / Motor DT12 / DC16 Até Euro 4 / Motor DC13 Série 5	6	IN - EX	GC0760064	STD	16.01 x 10.01 x 73.00	FG	F-8
Motor D10 / DS10 / DS11 / DN11 / DS14 / DSC14 - L111, T112, K112 - Sem Retentor	6	IN	GA0760048*	STD	18.02 x 11.00 x 80.00	FG	A-8
		EX	GE0760049*	STD	18.02 x 11.00 x 73.00	FG	A-8
Motor DN11 / DS11 / DSC11 - L110, L111, L113, 113H Ecológico	6	EX	GE0760051	STD	18.02 x 11.00 x 68.00	FG	F-8

(*) Item sob consulta

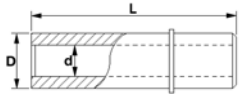
	Nº CIL.	TIPO TYPE	CÓD. MAHLE / METAL LEVE	MEDIDA		MATERIAL	FORMA
					D x d x L		
Motor 1.4 16v 4ZZFE / 1.6 16v 3ZZFE / 1.8 16v 1ZZFE - Corolla, Avensis, MR2, RAV4	4	IN - EX	GC0630444*	STD	10.34 x 5.52 x 34.50	FG	P
Motor 1.6 16v 4AFE / 1.8 16v 7AFE - Corolla, Celica, Carina	4	IN - EX	GC0630443*	STD	11.26 x 6.02 x 38.40	FG	P
Motor 2.4 / 2.8 - Hilux - Diesel	4	IN - EX	GC0630061	STD	13.07 x 8.01 x 40.00	FG	P
Motor 3.0L - Hilux - 1998->	4	IN - EX	GC0630445*	STD	13.05 x 8.02 x 42.00	FG	P-1
Motor 14B - Bandeirante	4	IN - EX	GC0630446*	STD	14.06 x 9.01 x 60.00	FG	P
			GC0630446*	0,05	14.11 x 9.01 x 60.00	FG	P

(*) Item sob consulta

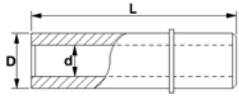
	Nº CIL.	TIPO TYPE	CÓD. MAHLE / METAL LEVE	MEDIDA		MATERIAL	FORMA
						D x d x L	
Motor 1.0 8v AE - Hobby, Gol - 1995->1997 - Gasolina	4	IN - EX	GC0700038	STD	11.12 x 7.00 x 43.00	FG	F-1
Motor 1.0 8v AT - Gol	4	IN - EX	GC0700090	STD	11.08 x 7.00 x 33.00	B	N
Motor 1.0 16v AT / Motor 1.0 16v Turbo / Motor 1.0 16v Power - Gol	4	IN - EX	GC0700093	STD 1	11.06 x 6.01 x 36.00	B	N
				STD 2	11.09 x 6.01 x 36.00		
Motor 1.3 / 1.5 / 1.6 - Jan/1967->Out/1986	4	IN	GA0700070	STD 1	12.07 x 8.00 x 64.00	B	A
				STD 2	12.09 x 8.00 x 64.00		
				0,05	12.12 x 8.00 x 64.00		
				0,10	12.17 x 8.00 x 64.00		
				0,20	12.27 x 8.00 x 64.00		
Motor 1.3 / 1.5	4	EX	GE0700075	STD 1	12.07 x 8.00 x 64.00	B	A-6
				STD 2	12.09 x 8.00 x 64.00		
				0,05	12.12 x 8.00 x 64.00		
				0,10	12.17 x 8.00 x 64.00		
				0,20	12.27 x 8.00 x 64.00		
Motor 1.5 AP / 1.6 AP - Passat Antigo - Biela Curta	4	IN - EX	GC0700080	STD 1	12.06 x 8.00 x 36.50	B	F-1
				STD 2	12.09 x 8.00 x 36.50		
				0,05	12.11 x 8.00 x 36.50		
				0,10	12.16 x 8.00 x 36.50		
Motor 1.6 - Gol BX, Saveiro BX, Kombi - Jan/1967->Out/1986	4	EX	GE0700088	STD 1	13.07 x 8.98 x 64.00	B	A-6
				STD 2	13.09 x 8.98 x 64.00		
				0,10*	13.17 x 8.98 x 64.00		
				0,20*	13.27 x 8.98 x 64.00		
Motor 1.6 EA113 / 2.0 APK - Golf - Gasolina	4	IN - EX	GC0700095	STD	12.06 x 7.00 x 36.60	B	N
Motor 1.6 AP / 1.8 AP / 2.0 AP - Biela Longa / MI - Passat, Santana - Gasolina / Álcool / Motor 1.6 - Kombi - Diesel	4	IN - EX	GC0700084	STD 1	12.06 x 8.00 x 42.50	B	F-1
				STD 2	12.09 x 8.00 x 42.50		
				0,05	12.11 x 8.00 x 42.50		
				0,10	12.16 x 8.00 x 42.50		

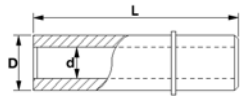
	Nº CIL.	TIPO TYPE	CÓD. MAHLE / METAL LEVE	MEDIDA		MATERIAL	FORMA
					D x d x L		
Motor D12C / D12A / D12D - 340cv, 380cv, 420cv - FH12, FM12, NH12	6	IN - EX	GC0710067	STD	15.00 x 8.00 x 83.50	FG	N
Motor TD10A / TD101 / TD102F/FS/FT / TD122 / TD123EDC - N10B, NL10, N12AB	6	IN	GA0710025	STD	18.00 x 11.04 x 82.00	FG	A-3
		EX	GE0710024	STD	18.01 x 11.04 x 66.00	FG	A

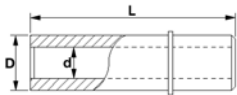
	Nº CIL.	TIPO TYPE	CÓD. MAHLE / METAL LEVE	MEDIDA		MATERIAL	FORMA
					D x d x L		
Modelo B8 / B8C / NT75	-	IN - EX	GC2310447*	STD	13.05 x 8.01 x 56.90	FG	G-6

(*) Item sob consulta

MAHLE	ORIGINAL	RIOSULENSE	300 INDY	LINHA MOTORA
GA0140003-STD	3688760	11013040	G 1097	GENERAL MOTORS
GA0140047-STD	-	11542040	G 3023	GENERAL MOTORS
GA0140047-0,10	-	11542140	G 3023-10	GENERAL MOTORS
GA0230434-STD	119138	11040030	G 3098	FORD WILLYS
GA0480001-STD	-	11002048	G 3136	MERCEDES-BENZ
GA0480007-STD	3120530230	11043020	G 1350	MERCEDES-BENZ
GA0480013-STD	3460530929	11184020	G 2672	MERCEDES-BENZ
GA0480033-STD	3520532229	11288020	G 2665	MERCEDES-BENZ
GA0480033-0,05	3520530729	11288920	G 2665-05	MERCEDES-BENZ
GA0510436-STD	12204PJ7305	111765045	G 3230	HONDA
GA0570017-STD	33261732	11198050	G 1549	PERKINS (MAXION)
GA0700070-STD 1	-	-	-	VOLKSWAGEN
GA0700070-STD 2	-	12145910	G 1502B-02	VOLKSWAGEN
GA0700070-0,05	-	12145110	G 1502B-05	VOLKSWAGEN
GA0700070-0,10	311101335 / 113101402	12145210	G 1502B-10	VOLKSWAGEN
GA0700070-0,20	-	12145310	G 1502B-20	VOLKSWAGEN
GA0710025-STD	422320	11231060	G 2086	VOLVO
GA0760048-STD	300957	11558035	G 1911	SCANIA
GA2110438-STD	MRF0110104 / ORF 01-10-280	11539054	G 2169	KIA MOTORS
GC0010069-STD	4749395	11939070	G 2123	FIAT-IVECO
GC0010069-0,05	-	11939970	G 2123-05	FIAT-IVECO
GC0010069-0,10	-	11939170	G 2123-10	FIAT-IVECO
GC0010069-0,20	-	11939270	G 2123-20	FIAT-IVECO
GC0060431-STD 1	7006006004	12229005	G 3094B	AGRALE
GC0110011-STD	5S4598 / 2P1262	11168000	G 1610	CATERPILLAR
GC0130008-STD	630503320034	11090080	G 1939	MWM
GC0130037-STD	922503320024	11290080	G 1931	MWM
GC0130041-STD	922983320014	11322080	G 2919	MWM
GC0130042-STD	961083320024	11323080	G 2106	MWM
GC0130063-STD	91078332002	11785080	G 2658	MWM
GC0130441-STD	KD12-17301	11119080	G 3025	MWM
GC0140027-STD	-	11237040	G 2149	GENERAL MOTORS
GC0140029-STD	-	11244040	G 2016	GENERAL MOTORS
GC0140029-0,05	-	11244940	G 2016-05	GENERAL MOTORS
GC0140092-STD 1	-	12571040	G 2016B	GENERAL MOTORS
GC0180062-STD	7701450816 / 7701452337	11768031	G 1459	RENAULT
GC0180442-STD 1	7700109151	121680031	G 2865B	RENAULT
GC0210023-STD	3553870 / 3923564 / 3901187	11221015	G 2593	CUMMINS
GC0210054-STD	3906206	11705015	G 2826	CUMMINS
GC0210432-STD	4934063	112066015	G 3312	CUMMINS
GC0250019-STD	4373602	11200070	G 1583	FIAT
GC0250028-STD	1044166	11239070	G 1715	FIAT
GC0250039-STD	7616993	11317070	G 2090	FIAT
GC0250040-STD	4371509 / 4250801	11318070	G 2148	FIAT
GC0250055-STD	7757502	11709070	G 3043	FIAT
GC0250091-STD	4373602 / 4354245 / 4222854	12568070	G 1583B	FIAT
GC0250096-STD	46736247	111086070	G 3061	FIAT
GC0250097-STD	46740631	111102070	G 3060	FIAT
GC0250100-STD	-	121101070	G 3043B	FIAT
GC0250433-STD	-	111922070	G 3290	FIAT
GC0260032-STD	-	11286030	G 3096	FORD
GC0480030-STD	4030530030 / 4220530130 / 4220530430	11260020	G 2055	MERCEDES-BENZ
GC0480053-STD	5410531230	11608020	G 2906	MERCEDES-BENZ
GC0480068-STD	9060530529	11837020	G 2869	MERCEDES-BENZ
GC0480439-STD	A6110530329	111491020	G 3262	MERCEDES-BENZ
GC0510058-STD	12206HYO305	11735045	G 3091	HONDA

MAHLE	ORIGINAL	RIOSULENSE	300 INDY	LINHA MOTORA
GC0510099-STD	12204KRM305	111490045	G 3133	HONDA
GC0570005-STD	33261723	11038050	G 2750	PERKINS (MAXION)
GC0570009-STD	70-420001	11121050	G 1910	PERKINS (MAXION)
GC0570015-STD	33431503	11194050	G 1550	PERKINS (MAXION)
GC0570016-STD	-	11195050	G 2921	PERKINS (MAXION)
GC0570043-STD	70470017 / 70470019	11507050	G 2110	GENERAL MOTORS
GC0570043-STD	70470017 / 70470019	11507050	G 2110	PERKINS (MAXION)
GC0570056-STD	ETC8003C	11710050	G 2096	PERKINS (MAXION)
GC0570056-STD	ETC8003C	11710050	G 2096	MERCEDES-BENZ
GC0570056-0,10	-	11710150	G 2096-10	MERCEDES-BENZ
GC0590010-STD	47780	11163030	G 1149	FORD
GC0590020-STD	84AU6510A	11206030	G 2019	FORD
GC0590060-STD	89 BM 6500 AB	11763030	G 2609	FORD
GC0590066-STD	-	11810030	G 2924	FORD
GC0590435-STD	70420027 / 3044493R2	112054050	G 3311	FORD
GC0630061-STD	11122-54040	11765098	G 2129	TOYOTA
GC0630443-STD	11122-15030	111782098	G 3456	TOYOTA
GC0630444-STD	11122-20020	111783098	G 3455	TOYOTA
GC0630445-STD	11122-67020	111876098	G 3416	TOYOTA
GC0630446-STD	11122-56030	11991098	G 2128	TOYOTA
GC0630446-0,05	-	11991998	G 2128-05	TOYOTA
GC0700038-STD	-	11300010	G 2918	VOLKSWAGEN
GC0700080-STD 1	056.103.419.A	12164010	G 1901B	VOLKSWAGEN
GC0700080-STD 2	-	12164910	G 1901B-03	VOLKSWAGEN
GC0700080-0,05	056.103.419.A	12164110	G 1901B-05	VOLKSWAGEN
GC0700080-0,10	-	12164210	G 1901B-10	VOLKSWAGEN
GC0700084-STD 1	5300-142	12238010	G 1921B	VOLKSWAGEN
GC0700084-STD 2	-	12238910	G 1921B-03	VOLKSWAGEN
GC0700084-0,05	49103419	12238110	G 1921B-05	VOLKSWAGEN
GC0700084-0,10	-	12238210	G 1921B-10	VOLKSWAGEN
GC0700090-STD	032.103.419.A	12549010	G 3042B	VOLKSWAGEN
GC0700093-STD 1	058.103.415	12725010	G 3015B	VOLKSWAGEN
GC0700093-STD 2	-	12725910	G 3015B-03	VOLKSWAGEN
GC0700095-STD	037.103.419.B	12757010	G 2067B	VOLKSWAGEN
GC0710067-STD	1546437 / 20905400	11818060	G 2018	VOLVO
GC0720045-STD	K80010104B	11533056	G 2922	ASIA MOTORS
GC0720046-STD	AA10010281	11537056	G 2923	ASIA MOTORS
GC0760064-STD	1334464	11798035	G 2984	SCANIA
GC2080050-STD	-	11565064	G 2776	HYUNDAI
GC2110052-STD	-	11581054	G 2700	KIA MOTORS
GC2110065-STD	K65A10104A	11809054	G 2613	KIA MOTORS
GC2310012-STD	B9B516	11173085	G 3086	FORD WILLYS
GC2310021-STD	NSB90	11215085	G 3131	FORD WILLYS
GC2310447-STD	B8B516	11172085	G 3085	YANMAR
GE0140004-STD	3688761	11014040	G 3103	GENERAL MOTORS
GE0230006-STD	119149	11039030	G 3097	FORD WILLYS
GE0250059-STD	46413458	11759070	G 2882	FIAT
GE0480002-STD	-	11003048	G 3137	MERCEDES-BENZ
GE0480014-STD	3550530030	11185020	G 2671	MERCEDES-BENZ
GE0480026-STD	3520532030	11232020	G 1930	MERCEDES-BENZ
GE0480031-STD	3520531630	11265020	G 1590	MERCEDES-BENZ
GE0480035-STD	3520533730	11289020	G 2666	MERCEDES-BENZ
GE0480035-0,05	3520530230	11289920	G 2666-05	MERCEDES-BENZ
GE0480044-STD	-	11524020	G 3138	MERCEDES-BENZ
GE0510022-STD	12023365300 / 120234373001 / 2206K05305	11218045	G 3088	HONDA
GE0510098-STD	12205KGA305	111336045	G 3132	HONDA

MAHLE	ORIGINAL	RIOSULENSE	300 INDY	LINHA MOTORA
GE0510437-STD	12205PJ7305	111764045	G 3231	HONDA
GE0570018-STD	33261754	11199050	G 1548	PERKINS (MAXION)
GE0700075-STD 1	-	12146010	G 1503B	VOLKSWAGEN
GE0700075-STD 2	-	12146910	G 1503B-02	VOLKSWAGEN
GE0700075-0,05	-	12146110	G 1503B-05	VOLKSWAGEN
GE0700075-0,10	311101329 / 113101416	12146210	G 1503B-10	VOLKSWAGEN
GE0700075-0,20	-	12146310	G 1503B-20	VOLKSWAGEN
GE0700088-STD 1	21101417	12248010	G 2829B	VOLKSWAGEN
GE0700088-STD 2	21101417	12248910	G 2829B-02	VOLKSWAGEN
GE0700088-0,10	-	12248210	G 2829B-10	VOLKSWAGEN
GE0700088-0,20	-	12248310	G 2829B-20	VOLKSWAGEN
GE0710024-STD	421297	11230060	G 2087	VOLVO
GE0760049-STD	300958	11559035	G 1912	SCANIA
GE0760051-STD	1398624	11573035	G 2114	SCANIA
GE1950440-STD	ME200009	111355008	G 3093	MITSUBISHI

ORIGINAL	MAHLE	RIOSULENSE	300 INDY	Linha Motora
032.103.419.A	GC0700090-STD	12549010	G 3042B	VOLKSWAGEN
037.103.419.B	GC0700095-STD	12757010	G 2067B	VOLKSWAGEN
056.103.419.A	GC0700080-0,05	12164110	G 1901B-05	VOLKSWAGEN
056.103.419.A	GC0700080-STD 1	12164010	G 1901B	VOLKSWAGEN
1044166	GC0250028-STD	11239070	G 1715	FIAT
11122-15030	GC0630443-STD	111782098	G 3456	TOYOTA
11122-20020	GC0630444-STD	111783098	G 3455	TOYOTA
11122-54040	GC0630061-STD	11765098	G 2129	TOYOTA
11122-56030	GC0630446-STD	11991098	G 2128	TOYOTA
11122-67020	GC0630445-STD	111876098	G 3416	TOYOTA
119138	GA0230434-STD	11040030	G 3098	FORD WILLYS
119149	GE0230006-STD	11039030	G 3097	FORD WILLYS
12204PJ7305	GA0510436-STD	111765045	G 3230	HONDA
12205PJ7305	GE0510437-STD	111764045	G 3231	HONDA
12206HYO305	GC0510058-STD	11735045	G 3091	HONDA
12204KRM305	GC0510099-STD	111490045	G 3133	HONDA
12023365300 / 120234373001 / 2206K05305	GE0510022-STD	11218045	G 3088	HONDA
12205KGA305	GE0510098-STD	111336045	G 3132	HONDA
1334464	GC0760064-STD	11798035	G 2984	SCANIA
1398624	GE0760051-STD	11573035	G 2114	SCANIA
1546437/20905400	GC0710067-STD	11818060	G 2018	VOLVO
21101417	GE0700088-STD 1	12248010	G 2829B	VOLKSWAGEN
21101417	GE0700088-STD 2	12248910	G 2829B-02	VOLKSWAGEN
300957	GA0760048-STD	11558035	G 1911	SCANIA
300958	GE0760049-STD	11559035	G 1912	SCANIA
3120530230	GA0480007-STD	11043020	G 1350	MERCEDES-BENZ
311101335 / 113101402	GA0700070-0,10	12145210	G 1502B-10	VOLKSWAGEN
311101329 / 113101416	GE0700075-0,10	12146210	G 1503B-10	VOLKSWAGEN
33261732	GA0570017-STD	11198050	G 1549	PERKINS (MAXION)
33261723	GC0570005-STD	11038050	G 2750	PERKINS (MAXION)
33431503	GC0570015-STD	11194050	G 1550	PERKINS (MAXION)
33261754	GE0570018-STD	11199050	G 1548	PERKINS (MAXION)
3460530929	GA0480013-STD	11184020	G 2672	MERCEDES-BENZ
3520530729	GA0480033-0,05	11288920	G 2665-05	MERCEDES-BENZ
3520532229	GA0480033-STD	11288020	G 2665	MERCEDES-BENZ
3553870 / 3923564 / 3901187	GC0210023-STD	11221015	G 2593	CUMMINS
3550530030	GE0480014-STD	11185020	G 2671	MERCEDES-BENZ
3520532030	GE0480026-STD	11232020	G 1930	MERCEDES-BENZ
3520531630	GE0480031-STD	11265020	G 1590	MERCEDES-BENZ
3520530230	GE0480035-0,05	11289920	G 2666-05	MERCEDES-BENZ
3520533730	GE0480035-STD	11289020	G 2666	MERCEDES-BENZ
3688760	GA0140003-STD	11013040	G 1097	GENERAL MOTORS
3688761	GE0140004-STD	11014040	G 3103	GENERAL MOTORS
3906206	GC0210054-STD	11705015	G 2826	CUMMINS
4030530030	GC0480030-STD	11260020	G 2055	MERCEDES-BENZ
4030530030 / 4220530130 / 4220530430	GC0480030-STD	11260020	G 2055	MERCEDES-BENZ
422320	GA0710025-STD	11231060	G 2086	VOLVO
421297	GE0710024-STD	11230060	G 2087	VOLVO
4373602	GC0250019-STD	11200070	G 1583	FIAT
4371509 / 4250801	GC0250040-STD	11318070	G 2148	FIAT
4373602 / 4354245 / 4222854	GC0250091-STD	12568070	G 1583B	FIAT
46736247	GC0250096-STD	111086070	G 3061	FIAT
46740631	GC0250097-STD	111102070	G 3060	FIAT
46413458	GE0250059-STD	11759070	G 2882	FIAT
4749395	GC0010069-STD	11939070	G 2123	FIAT-IVECO
47780	GC0590010-STD	11163030	G 1149	FORD

ORIGINAL	MAHLE	RIOSULENSE	300 INDY	Linha Motora
49103419	GC0700084-0,05	12238110	G 1921B-05	VOLKSWAGEN
4934063	GC0210432-STD	112066015	G 3312	CUMMINS
5300-142	GC0700084-STD 1	12238010	G 1921B	VOLKSWAGEN
5410531230	GC0480053-STD	11608020	G 2906	MERCEDES-BENZ
58.103.415	GC0700093-STD 1	12725010	G 3015B	VOLKSWAGEN
5S4598 / 2P1262	GC0110011-STD	11168000	G 1610	CATERPILLAR
630503320034	GC0130008-STD	11090080	G 1939	MWM
7006006004	GC0060431-STD 1	12229005	G 3094B	AGRALE
70-420001	GC0570009-STD	11121050	G 1910	PERKINS (MAXION)
70420027 / 3044493R2	GC0590435-STD	112054050	G 3311	FORD
70470017	GC0570043-STD	-	-	GENERAL MOTORS
70470017 / 70470019	GC0570043-STD	11507050	G 2110	PERKINS (MAXION)
7616993	GC0250039-STD	11317070	G 2090	FIAT
7700109151	GC0180442-STD 1	121680031	G 2865B	RENAULT
7701450816 / 7701452337	GC0180062-STD	11768031	G 1459	RENAULT
7757502	GC0250055-STD	11709070	G 3043	FIAT
84AU6510A	GC0590020-STD	11206030	G 2019	FORD
89 BM 6500 AB	GC0590060-STD	11763030	G 2609	FORD
9060530529	GC0480068-STD	11837020	G 2869	MERCEDES-BENZ
91078332002	GC0130063-STD	11785080	G 2658	MWM
922503320024	GC0130037-STD	11290080	G 1931	MWM
922983320014	GC0130041-STD	11322080	G 2919	MWM
961083320024	GC0130042-STD	11323080	G 2106	MWM
A6110530329	GC0480439-STD	111491020	G 3262	MERCEDES-BENZ
AA10010281	GC0720046-STD	11537056	G 2923	ASIA MOTORS
B8B516	GC2310447-STD	11172085	G 3085	YANMAR
B9B516	GC2310012-STD	11173085	G 3086	FORD WILLYS
ETC8003C	GC0570056-STD	11710050	G 2096	MERCEDES-BENZ
ETC8003C	GC0570056-STD	11710050	G 2096	PERKINS (MAXION)
K65A10104A	GC2110065-STD	11809054	G 2613	KIA MOTORS
K80010104B	GC0720045-STD	11533056	G 2922	ASIA MOTORS
KD12-17301	GC0130441-STD	11119080	G 3025	MWM
ME200009	GE1950440-STD	111355008	G 3093	MITSUBISHI
MRF0110104 / ORF 01-10-280	GA2110438-STD	11539054	G 2169	KIA MOTORS
NSB90	GC2310021-STD	11215085	G 3131	FORD WILLYS

RIOSULENSE	MAHLE	ORIGINAL	300 INDY	Linha Motora
11002048	GA0480001-STD	-	G 3136	MERCEDES-BENZ
11003048	GE0480002-STD	-	G 3137	MERCEDES-BENZ
11013040	GA0140003-STD	3688760	G 1097	GENERAL MOTORS
11014040	GE0140004-STD	3688761	G 3103	GENERAL MOTORS
11038050	GC0570005-STD	33261723	G 2750	PERKINS (MAXION)
11039030	GE0230006-STD	119149	G 3097	FORD WILLYS
11040030	GA0230434-STD	119138	G 3098	FORD WILLYS
11043020	GA0480007-STD	3120530230	G 1350	MERCEDES-BENZ
11090080	GC0130008-STD	630503320034	G 1939	MWM
111086070	GC0250096-STD	46736247	G 3061	FIAT
111102070	GC0250097-STD	46740631	G 3060	FIAT
11119080	GC0130441-STD	KD12-17301	G 3025	MWM
11121050	GC0570009-STD	70-420001	G 1910	PERKINS (MAXION)
111336045	GE0510098-STD	12205KGA305	G 3132	HONDA
111355008	GE1950440-STD	ME200009	G 3093	MITSUBISHI
111490045	GC0510099-STD	12204KRM305	G 3133	HONDA
111491020	GC0480439-STD	A6110530329	G 3262	MERCEDES-BENZ
11163030	GC0590010-STD	47780	G 1149	FORD
11168000	GC0110011-STD	5S4598 / 2P1262	G 1610	CATERPILLAR
11172085	GC2310447-STD	B8B516	G 3085	YANMAR
11173085	GC2310012-STD	B9B516	G 3086	FORD WILLYS
111764045	GE0510437-STD	12205PJ7305	G 3231	HONDA
111765045	GA0510436-STD	12204PJ7305	G 3230	HONDA
111782098	GC0630443-STD	11122-15030	G 3456	TOYOTA
111783098	GC0630444-STD	11122-20020	G 3455	TOYOTA
11184020	GA0480013-STD	3460530929	G 2672	MERCEDES-BENZ
11185020	GE0480014-STD	3550530030	G 2671	MERCEDES-BENZ
111876098	GC0630445-STD	11122-67020	G 3416	TOYOTA
111922070	GC0250433-STD	-	G 3290	FIAT
11194050	GC0570015-STD	33431503	G 1550	PERKINS (MAXION)
11195050	GC0570016-STD	-	G 2921	PERKINS (MAXION)
11198050	GA0570017-STD	33261732	G 1549	PERKINS (MAXION)
11199050	GE0570018-STD	33261754	G 1548	PERKINS (MAXION)
11200070	GC0250019-STD	4373602	G 1583	FIAT
112054050	GC0590435-STD	70420027 / 3044493R2	G 3311	FORD
11206030	GC0590020-STD	84AU6510A	G 2019	FORD
112066015	GC0210432-STD	4934063	G 3312	CUMMINS
11215085	GC2310021-STD	NSB90	G 3131	FORD WILLYS
11218045	GE0510022-STD	12023365300 / 120234373001 / 2206K05305	G 3088	HONDA
11221015	GC0210023-STD	3553870 / 3923564 / 3901187	G 2593	CUMMINS
11230060	GE0710024-STD	421297	G 2087	VOLVO
11231060	GA0710025-STD	422320	G 2086	VOLVO
11232020	GE0480026-STD	3520532030	G 1930	MERCEDES-BENZ
11237040	GC0140027-STD	-	G 2149	GENERAL MOTORS
11239070	GC0250028-STD	1044166	G 1715	FIAT
11244040	GC0140029-STD	-	G 2016	GENERAL MOTORS
11244940	GC0140029-0,05	-	G 2016-05	GENERAL MOTORS
11260020	GC0480030-STD	4030530030 / 4220530130 / 4220530430	G 2055	MERCEDES-BENZ
11265020	GE0480031-STD	3520531630	G 1590	MERCEDES-BENZ
11286030	GC0260032-STD	-	G 3096	FORD
11288020	GA0480033-STD	3520532229	G 2665	MERCEDES-BENZ
11288920	GA0480033-0,05	3520530729	G 2665-05	MERCEDES-BENZ
11289020	GE0480035-STD	3520533730	G 2666	MERCEDES-BENZ
11289920	GE0480035-0,05	3520530230	G 2666-05	MERCEDES-BENZ
11290080	GC0130037-STD	922503320024	G 1931	MWM
11300010	GC0700038-STD	-	G 2918	VOLKSWAGEN

RIOSULENSE	MAHLE	ORIGINAL	300 INDY	Linha Motora
11317070	GC0250039-STD	7616993	G 2090	FIAT
11318070	GC0250040-STD	4371509 / 4250801	G 2148	FIAT
11322080	GC0130041-STD	922983320014	G 2919	MWM
11323080	GC0130042-STD	961083320024	G 2106	MWM
11507050	GC0570043-STD	70470017 / 70470019	G 2110	PERKINS (MAXION)
11524020	GE0480044-STD	-	G 3138	MERCEDES-BENZ
11533056	GC0720045-STD	K80010104B	G 2922	ASIA MOTORS
11537056	GC0720046-STD	AA10010281	G 2923	ASIA MOTORS
11539054	GA2110438-STD	MRF0110104 / ORF 01-10-280	G 2169	KIA MOTORS
11542040	GA0140047-STD	-	G 3023	GENERAL MOTORS
11542140	GA0140047-0,10	-	G 3023-10	GENERAL MOTORS
11558035	GA0760048-STD	300957	G 1911	SCANIA
11559035	GE0760049-STD	300958	G 1912	SCANIA
11565064	GC2080050-STD	-	G 2776	HYUNDAI
11573035	GE0760051-STD	1398624	G 2114	SCANIA
11581054	GC2110052-STD	-	G 2700	KIA MOTORS
11608020	GC0480053-STD	5410531230	G 2906	MERCEDES-BENZ
11705015	GC0210054-STD	3906206	G 2826	CUMMINS
11709070	GC0250055-STD	7757502	G 3043	FIAT
11710050	GC0570056-STD	ETC8003C	G 2096	MERCEDES-BENZ
11710050	GC0570056-STD	ETC8003C	G 2096	PERKINS (MAXION)
11710150	GC0570056-0,10	-	G 2096-10	MERCEDES-BENZ
11735045	GC0510058-STD	12206HYO305	G 3091	HONDA
11759070	GE0250059-STD	46413458	G 2882	FIAT
11763030	GC0590060-STD	89 BM 6500 AB	G 2609	FORD
11765098	GC0630061-STD	11122-54040	G 2129	TOYOTA
11768031	GC0180062-STD	7701450816 / 7701452337	G 1459	RENAULT
11785080	GC0130063-STD	91078332002	G 2658	MWM
11798035	GC0760064-STD	1334464	G 2984	SCANIA
11809054	GC2110065-STD	K65A10104A	G 2613	KIA MOTORS
11810030	GC0590066-STD	-	G 2924	FORD
11818060	GC0710067-STD	1546437/20905400	G 2018	VOLVO
11837020	GC0480068-STD	9060530529	G 2869	MERCEDES-BENZ
11939070	GC0010069-STD	4749395	G 2123	FIAT-IVECO
11939170	GC0010069-0,10	-	G 2123-10	FIAT-IVECO
11939270	GC0010069-0,20	-	G 2123-20	FIAT-IVECO
11939970	GC0010069-0,05	-	G 2123-05	FIAT-IVECO
11991098	GC0630446-STD	11122-56030	G 2128	TOYOTA
11991998	GC0630446-0,05	-	G 2128-05	TOYOTA
121101070	GC0250100-STD	-	G 3043B	FIAT
12145110	GA0700070-0,05	-	G 1502B-05	VOLKSWAGEN
12145210	GA0700070-0,10	311101335 / 113101402	G 1502B-10	VOLKSWAGEN
12145310	GA0700070-0,20	-	G 1502B-20	VOLKSWAGEN
12145910	GA0700070-STD 2	-	G 1502B-02	VOLKSWAGEN
12146010	GE0700075-STD 1	-	G 1503B	VOLKSWAGEN
12146110	GE0700075-0,05	-	G 1503B-05	VOLKSWAGEN
12146210	GE0700075-0,10	311101329 / 113101416	G 1503B-10	VOLKSWAGEN
12146310	GE0700075-0,20	-	G 1503B-20	VOLKSWAGEN
12146910	GE0700075-STD 2	-	G 1503B-02	VOLKSWAGEN
12164010	GC0700080-STD 1	056.103.419.A	G 1901B	VOLKSWAGEN
12164110	GC0700080-0,05	056.103.419.A	G 1901B-05	VOLKSWAGEN
12164210	GC0700080-0,10	-	G 1901B-10	VOLKSWAGEN
12164910	GC0700080-STD 2	-	G 1901B-03	VOLKSWAGEN
121680031	GC0180442-STD 1	7700109151	G 2865B	RENAULT
12229005	GC0060431-STD 1	7006006004	G 3094B	AGRALE
12238010	GC0700084-STD 1	5300-142	G 1921B	VOLKSWAGEN

RIOSULENSE	MAHLE	ORIGINAL	300 INDY	Linha Motora
12238110	GC0700084-0,05	49103419	G 1921B-05	VOLKSWAGEN
12238210	GC0700084-0,10	-	G 1921B-10	VOLKSWAGEN
12238910	GC0700084-STD 2	-	G 1921B-03	VOLKSWAGEN
12248010	GE0700088-STD 1	21101417	G 2829B	VOLKSWAGEN
12248210	GE0700088-0,10	-	G 2829B-10	VOLKSWAGEN
12248310	GE0700088-0,20	-	G 2829B-20	VOLKSWAGEN
12248910	GE0700088-STD 2	21101417	G 2829B-02	VOLKSWAGEN
12549010	GC0700090-STD	032.103.419.A	G 3042B	VOLKSWAGEN
12568070	GC0250091-STD	4373602 / 4354245 / 4222854	G 1583B	FIAT
12571040	GC0140092-STD 1	-	G 2016B	GENERAL MOTORS
12725010	GC0700093-STD 1	058.103.415	G 3015B	VOLKSWAGEN
12725910	GC0700093-STD 2	-	G 3015B-03	VOLKSWAGEN
12757010	GC0700095-STD	037.103.419.B	G 2067B	VOLKSWAGEN

300 INDY	MAHLE	ORIGINAL	RIOSULENSE	Linha Motora
G 1097	GA0140003-STD	3688760	11013040	GENERAL MOTORS
G 1149	GC0590010-STD	47780	11163030	FORD
G 1350	GA0480007-STD	3120530230	11043020	MERCEDES-BENZ
G 1459	GC0180062-STD	7701450816 / 7701452337	11768031	RENAULT
G 1502B-02	GA0700070-STD 2	-	12145910	VOLKSWAGEN
G 1502B-05	GA0700070-0,05	-	12145110	VOLKSWAGEN
G 1502B-10	GA0700070-0,10	311101335 / 113101402	12145210	VOLKSWAGEN
G 1502B-20	GA0700070-0,20	-	12145310	VOLKSWAGEN
G 1503B	GE0700075-STD 1	-	12146010	VOLKSWAGEN
G 1503B-02	GE0700075-STD 2	-	12146910	VOLKSWAGEN
G 1503B-05	GE0700075-0,05	-	12146110	VOLKSWAGEN
G 1503B-10	GE0700075-0,10	311101329 / 113101416	12146210	VOLKSWAGEN
G 1503B-20	GE0700075-0,20	-	12146310	VOLKSWAGEN
G 1548	GE0570018-STD	33261754	11199050	PERKINS (MAXION)
G 1549	GA0570017-STD	33261732	11198050	PERKINS (MAXION)
G 1550	GC0570015-STD	33431503	11194050	PERKINS (MAXION)
G 1583	GC0250019-STD	4373602	11200070	FIAT
G 1583B	GC0250091-STD	4373602 / 4354245 / 4222854	12568070	FIAT
G 1590	GE0480031-STD	3520531630	11265020	MERCEDES-BENZ
G 1610	GC0110011-STD	5S4598 / 2P1262	11168000	CATERPILLAR
G 1715	GC0250028-STD	1044166	11239070	FIAT
G 1901B	GC0700080-STD 1	056.103.419.A	12164010	VOLKSWAGEN
G 1901B-03	GC0700080-STD 2	-	12164910	VOLKSWAGEN
G 1901B-05	GC0700080-0,05	056.103.419.A	12164110	VOLKSWAGEN
G 1901B-10	GC0700080-0,10	-	12164210	VOLKSWAGEN
G 1910	GC0570009-STD	70-420001	11121050	PERKINS (MAXION)
G 1911	GA0760048-STD	300957	11558035	SCANIA
G 1912	GE0760049-STD	300958	11559035	SCANIA
G 1921B	GC0700084-STD 1	5300-142	12238010	VOLKSWAGEN
G 1921B-03	GC0700084-STD 2	-	12238910	VOLKSWAGEN
G 1921B-05	GC0700084-0,05	49103419	12238110	VOLKSWAGEN
G 1921B-10	GC0700084-0,10	-	12238210	VOLKSWAGEN
G 1930	GE0480026-STD	3520532030	11232020	MERCEDES-BENZ
G 1931	GC0130037-STD	922503320024	11290080	MWM
G 1939	GC0130008-STD	630503320034	11090080	MWM
G 2016	GC0140029-STD	-	11244040	GENERAL MOTORS
G 2016-05	GC0140029-0,05	-	11244940	GENERAL MOTORS
G 2016B	GC0140092-STD 1	-	12571040	GENERAL MOTORS
G 2018	GC0710067-STD	1546437/20905400	11818060	VOLVO
G 2019	GC0590020-STD	84AU6510A	11206030	FORD
G 2055	GC0480030-STD	4030530030 / 4220530130 / 4220530430	11260020	MERCEDES-BENZ
G 2067B	GC0700095-STD	037.103.419.B	12757010	VOLKSWAGEN
G 2086	GA0710025-STD	422320	11231060	VOLVO
G 2087	GE0710024-STD	421297	11230060	VOLVO
G 2090	GC0250039-STD	7616993	11317070	FIAT
G 2096	GC0570056-STD	ETC8003C	11710050	MERCEDES-BENZ
G 2096	GC0570056-STD	ETC8003C	11710050	PERKINS (MAXION)
G 2096-10	GC0570056-0,10	-	11710150	MERCEDES-BENZ
G 2106	GC0130042-STD	961083320024	11323080	MWM
G 2110	GC0570043-STD	70470017 / 70470019	11507050	PERKINS (MAXION)
G 2114	GE0760051-STD	1398624	11573035	SCANIA
G 2123	GC0010069-STD	4749395	11939070	FIAT-IVECO
G 2123-05	GC0010069-0,05	-	11939970	FIAT-IVECO
G 2123-10	GC0010069-0,10	-	11939170	FIAT-IVECO
G 2123-20	GC0010069-0,20	-	11939270	FIAT-IVECO
G 2128	GC0630446-STD	11122-56030	11991098	TOYOTA

300 INDY	MAHLE	ORIGINAL	RIOSULENSE	Linha Motora
G 2128-05	GC0630446-0,05	-	11991998	TOYOTA
G 2129	GC0630061-STD	11122-54040	11765098	TOYOTA
G 2148	GC0250040-STD	4371509 / 4250801	11318070	FIAT
G 2149	GC0140027-STD	-	11237040	GENERAL MOTORS
G 2169	GA2110438-STD	MRF0110104 / ORF 01-10-280	11539054	KIA MOTORS
G 2593	GC0210023-STD	3553870 / 3923564 / 3901187	11221015	CUMMINS
G 2609	GC0590060-STD	89 BM 6500 AB	11763030	FORD
G 2613	GC2110065-STD	K65A10104A	11809054	KIA MOTORS
G 2658	GC0130063-STD	91078332002	11785080	MWM
G 2665	GA0480033-STD	3520532229	11288020	MERCEDES-BENZ
G 2665-05	GA0480033-0,05	3520530729	11288920	MERCEDES-BENZ
G 2666	GE0480035-STD	3520533730	11289020	MERCEDES-BENZ
G 2666-05	GE0480035-0,05	3520530230	11289920	MERCEDES-BENZ
G 2671	GE0480014-STD	3550530030	11185020	MERCEDES-BENZ
G 2672	GA0480013-STD	3460530929	11184020	MERCEDES-BENZ
G 2700	GC2110052-STD	-	11581054	KIA MOTORS
G 2750	GC0570005-STD	33261723	11038050	PERKINS (MAXION)
G 2776	GC2080050-STD	-	11565064	HYUNDAI
G 2826	GC0210054-STD	3906206	11705015	CUMMINS
G 2829B	GE0700088-STD 1	21101417	12248010	VOLKSWAGEN
G 2829B-02	GE0700088-STD 2	21101417	12248910	VOLKSWAGEN
G 2829B-10	GE0700088-0,10	-	12248210	VOLKSWAGEN
G 2829B-20	GE0700088-0,20	-	12248310	VOLKSWAGEN
G 2865B	GC0180442-STD 1	7700109151	121680031	RENAULT
G 2869	GC0480068-STD	9060530529	11837020	MERCEDES-BENZ
G 2882	GE0250059-STD	46413458	11759070	FIAT
G 2906	GC0480053-STD	5410531230	11608020	MERCEDES-BENZ
G 2918	GC0700038-STD	-	11300010	VOLKSWAGEN
G 2919	GC0130041-STD	922983320014	11322080	MWM
G 2921	GC0570016-STD	-	11195050	PERKINS (MAXION)
G 2922	GC0720045-STD	K80010104B	11533056	ASIA MOTORS
G 2923	GC0720046-STD	AA10010281	11537056	ASIA MOTORS
G 2924	GC0590066-STD	-	11810030	FORD
G 2984	GC0760064-STD	1334464	11798035	SCANIA
G 3015B	GC0700093-STD 1	058.103.415	12725010	VOLKSWAGEN
G 3015B-03	GC0700093-STD 2	-	12725910	VOLKSWAGEN
G 3023	GA0140047-STD	-	11542040	GENERAL MOTORS
G 3023-10	GA0140047-0,10	-	11542140	GENERAL MOTORS
G 3025	GC0130441-STD	KD12-17301	11119080	MWM
G 3042B	GC0700090-STD	032.103.419.A	12549010	VOLKSWAGEN
G 3043	GC0250055-STD	7757502	11709070	FIAT
G 3043B	GC0250100-STD	-	121101070	FIAT
G 3060	GC0250097-STD	46740631	111102070	FIAT
G 3061	GC0250096-STD	46736247	111086070	FIAT
G 3085	GC2310447-STD	B8B516	11172085	YANMAR
G 3086	GC2310012-STD	B9B516	11173085	FORD WILLYS
G 3088	GE0510022-STD	12023365300 / 120234373001 / 2206K05305	11218045	HONDA
G 3091	GC0510058-STD	12206HYO305	11735045	HONDA
G 3093	GE1950440-STD	ME200009	111355008	MITSUBISHI
G 3094B	GC0060431-STD 1	7006006004	12229005	AGRALE
G 3096	GC0260032-STD	-	11286030	FORD
G 3097	GE0230006-STD	119149	11039030	FORD WILLYS
G 3098	GA0230434-STD	119138	11040030	FORD WILLYS
G 3103	GE0140004-STD	3688761	11014040	GENERAL MOTORS
G 3131	GC2310021-STD	NSB90	11215085	FORD WILLYS
G 3132	GE0510098-STD	12205KGA305	111336045	HONDA

300 INDY	MAHLE	ORIGINAL	RIOSULENSE	Linha Motora
G 3133	GC0510099-STD	12204KRM305	111490045	HONDA
G 3136	GA0480001-STD	-	11002048	MERCEDES-BENZ
G 3137	GE0480002-STD	-	11003048	MERCEDES-BENZ
G 3138	GE0480044-STD	-	11524020	MERCEDES-BENZ
G 3230	GA0510436-STD	12204PJ7305	111765045	HONDA
G 3231	GE0510437-STD	12205PJ7305	111764045	HONDA
G 3262	GC0480439-STD	A6110530329	111491020	MERCEDES-BENZ
G 3290	GC0250433-STD	-	111922070	FIAT
G 3311	GC0590435-STD	70420027 / 3044493R2	112054050	FORD
G 3312	GC0210432-STD	4934063	112066015	CUMMINS
G 3416	GC0630445-STD	11122-67020	111876098	TOYOTA
G 3455	GC0630444-STD	11122-20020	111783098	TOYOTA
G 3456	GC0630443-STD	11122-15030	111782098	TOYOTA



Sedes de Válvulas

Os assentos das válvulas são fabricados com aços fundidos de altas ligas e passam por tratamentos térmicos em fornos de atmosfera controlada que garantem uma estrutura resistente ao impacto, atrito e às altas temperaturas provocadas pelos motores turboalimentados e pelas condições extremas dos motores a GNC/GLP.

A partir da utilização dos alojamentos de alumínio surgiu a necessidade de incorporação de insertos que sejam capazes de resistir a solicitações mecânicas que são produzidas na câmara de combustão.

Tipos e termos técnicos

SA - Sede de válvula de admissão.

SE - Sede de válvula de escape.

Função

- Impedir que a cabeça da válvula e o alojamento se fundam.
- Garantir um fechamento perfeito junto com a válvula para selar a câmara de combustão.
- Assegurar a condutividade térmica para a dissipação de calor da cabeça da válvula, pois esta retira aproximadamente 80% do calor contido por meio do assento dela.
- Manter as superfícies internas com coeficientes de deslizamentos altos para assegurar a correta fluidez da mistura ar e combustível.

Características indicadas na coluna de medidas:

D) diâmetro externo;

d) diâmetro interno;

h) altura;

a) ângulo da sede.

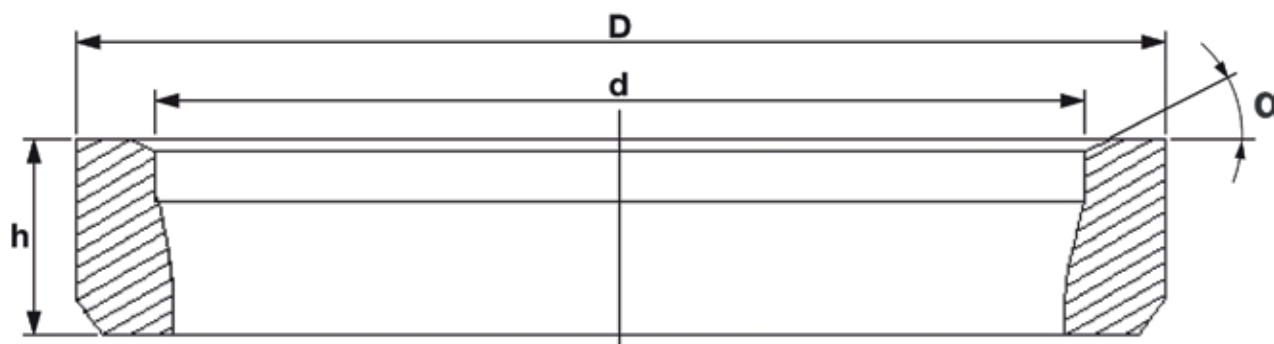

Estrutura da página e decodificação dos códigos das peças

1 MERCEDES-BENZ						MAHLE	
2	3	4	5	6	7		
					D x d x h	8	
Motor OM 352A/314-L1517/18 Turbo, OM 352-L1114 No Turbo	6	EX	SE0480038	STD	38,08 x 28 x 8,45	45°	
Motor OM 352A-L1517, L1518 Turbo	6	EX	SE0480038	STD	38,08 x 28 x 8,45	45°	
Motor OM 366 - OM 364LA Turbo Intercooler	4	IN	SA0480112	STD	43,87 x 34,5 x 7,5	20°	
Motor OM 366 Turbo	4/6	IN	SA0480059	0,1	43,97 x 35 x 7,4	30°	
		IN	SA0480059	0,2	44,07 x 35 x 7,4	30°	
		IN	SA0480059	0,3	44,17 x 35 x 7,4	30°	
		EX	SE0480080	0,1	38,17 x 30 x 8	45°	
		EX	SE0480080	0,2	38,37 x 30 x 8	45°	
		IN	SA0480059	STD	43,87 x 35 x 7,4	30°	
		EX	SE0480080	STD	38,07 x 30 x 8	45°	
		IN	SA0480087	0,1	43,97 x 35 x 7,7	30°	
Motor OM 366, OM 364 Asp. Normal y Turbo	4/6	IN	SA0480087	0,5	44,37 x 35 x 7,7	30°	
		EX	SE0480038	0,1	38,17 x 28 x 8,5	45°	
		EX	SE0480038	0,2	38,27 x 28 x 8,5	45°	
		EX	SE0480038	0,5	38,57 x 28 x 8,5	45°	
		EX	SE0480038	1,00	39,07 x 28 x 8,5	45°	
		EX	SE0480038	2,00	40,07 x 28 x 8,5	45°	
		EX	SE0480038	STD	38,08 x 28 x 8,45	45°	
		IN	SA0480087	STD	43,87 x 35 x 7,7	30°	
Motor OM 447LA-449LA	5/6	IN	SA0480090	0,1	60,2 x 49,3 x 8,35	30°	
		IN	SA0480090	STD	60,1 x 49,3 x 8,35	30°	
		EX	SE0480092	STD	53,1 x 43 x 9,2	45°	
Motor OM 501LA V6 24v., OM 502LA V8 32v., OM 457	6	IN	SA0480070	STD	47,39 x 36,5 x 7,8	30°	
		EX	SE0480032	STD	43,09 x 34,3 x 8	45°	
OM 355 - OM 355 O (ônibus) aspirado	5/6	EX	SE0480044	0,1	40,17 x 31 x 7,47	45°	
		EX	SE0480044	0,2	40,27 x 31 x 7,47	45°	
		IN	SA0480056	STD	51,07 x 37 x 7,47	45°	
		EX	SE0480044	STD	40,07 x 31 x 7,47	45°	
OM314 - OM352 - OM352A (Aspirado/ Turbinado)	4/6	IN	SA0480033	0,1	45,17 x 37 x 8,3	45°	
		IN	SA0480033	0,2	45,27 x 37 x 8,3	45°	
		IN	SA0480033	1,00	46,07 x 37 x 8,3	45°	
		SA0480033	0,00	47,07 x 37 x 8,3	45°		

1 Fabricante

2 Nome do motor

Dados do motor

Veículos

Ano de fabricação

3 Número do cilindro

4 Função

IN = Admissão

EX = Escape

IN - EX = Comum

5 Número de artigo da sede de válvula

Ex.: SA 048 0033

Número sequencial

Linha motora

SA - Sede de válvula de admissão

SE - Sede de válvula de escape

6 Medidas

7 Dimensões

8 Ângulo

Valve Seats

Valve seats are manufactured with high cast alloy steels and are thermally treated in ovens at controlled atmosphere to ensure a structure that is resistant to impact, friction and the high temperatures in turbo charger engines and extreme conditions of GNC/GLP engines.

Since the use of aluminum housings started, there has been a need to incorporate inserts that can withstand the mechanical demands produced in the combustion chamber.

Types and technical words

SA - Intake valve seat.

SE - Exhaust valve seat.

Purpose

- Prevent the valve head and the housing from melting.
- Ensure perfect closure with the valve to seal the combustion chamber.
- Ensure thermal conductivity to dissipate heat from the valve head, as it can remove about 80% of contained heat through its seat.
- Keep internal surfaces at high sliding rates to ensure appropriate flow of air and combustible mixture.

Characteristics described in the dimensions column

D) Outside Diameter

d) Inside Diameter

h) Height

a) Seat Angle

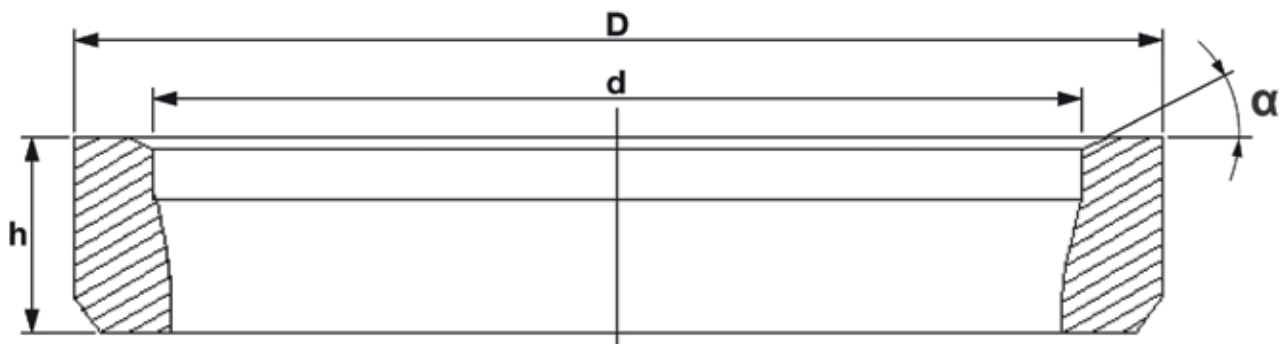

Page structure and part code decoding

1 MERCEDES-BENZ						MAHLE	
2	3	4	5	6	7		
					D x d x h	8	
Motor OM 352A/314-L1517/18 Turbo, OM 352-L1114 No Turbo	6	EX	SE0480038	STD	38,08 x 28 x 8,45	45°	
Motor OM 352A-L1517, L1518 Turbo	6	EX	SE0480038	STD	38,08 x 28 x 8,45	45°	
Motor OM 366 - OM 364LA Turbo Intercooler	4	IN	SA0480112	STD	43,87 x 34,5 x 7,5	20°	
Motor OM 366 Turbo	4/6	IN	SA0480059	0,1	43,97 x 35 x 7,4	30°	
		IN	SA0480059	0,2	44,07 x 35 x 7,4	30°	
		IN	SA0480059	0,3	44,17 x 35 x 7,4	30°	
		EX	SE0480080	0,1	38,17 x 30 x 8	45°	
		EX	SE0480080	0,2	38,37 x 30 x 8	45°	
		IN	SA0480059	STD	43,87 x 35 x 7,4	30°	
Motor OM 366, OM 364 Asp. Normal y Turbo	4/6	EX	SE0480080	STD	38,07 x 30 x 8	45°	
		IN	SA0480087	0,1	43,97 x 35 x 7,7	30°	
		IN	SA0480087	0,5	44,37 x 35 x 7,7	30°	
		EX	SE0480038	0,1	38,17 x 28 x 8,5	45°	
		EX	SE0480038	0,2	38,27 x 28 x 8,5	45°	
		EX	SE0480038	0,5	38,57 x 28 x 8,5	45°	
Motor OM 447LA-449LA	5/6	EX	SE0480038	1,00	39,07 x 28 x 8,5	45°	
		EX	SE0480038	2,00	40,07 x 28 x 8,5	45°	
		EX	SE0480038	STD	38,08 x 28 x 8,45	45°	
		IN	SA0480087	STD	43,87 x 35 x 7,7	30°	
Motor OM 501LA V6 24v., OM 502LA V8 32v., OM 457	6	IN	SA0480090	0,1	60,2 x 49,3 x 8,35	30°	
		IN	SA0480090	STD	60,1 x 49,3 x 8,35	30°	
		EX	SE0480092	STD	53,1 x 43 x 9,2	45°	
OM 355 - OM 355 O (ônibus) aspirado	5/6	EX	SE0480032	STD	47,39 x 36,5 x 7,8	30°	
		EX	SE0480044	STD	43,09 x 34,3 x 8	45°	
		EX	SE0480044	0,1	40,17 x 31 x 7,47	45°	
		EX	SE0480044	0,2	40,27 x 31 x 7,47	45°	
OM314 - OM352 - OM352A (Aspirado/ Turbinado)	4/6	IN	SA0480056	STD	51,07 x 37 x 7,47	45°	
		EX	SE0480044	STD	40,07 x 31 x 7,47	45°	
		IN	SA0480033	0,1	45,17 x 37 x 8,3	45°	
		IN	SA0480033	0,2	45,27 x 37 x 8,3	45°	
			IN	SA0480033	1,00	46,07 x 37 x 8,3	45°
			SA0480033	0,00	47,07 x 37 x 8,3	45°	
			SA0480033	0,00	47,07 x 37 x 8,3	45°	

- 1 Manufacturer
- 2 Engine Name
Engine Data
Vehicles
Manufacturing Year
- 3 Cylinder number
- 4 Function
IN = Intake
EX = Exhaust
IN - EX = Common

- 5 Valve Seat Part Number
Ex.: SA 048 0033
 - Sequence Number
 - Engine Line
 - SA - Intake valve seat
 - SE - Exhaust valve seat
- 6 Sizes
- 7 Dimensions
- 8 Angle

Asientos de Válvulas

Los asientos de válvulas son fabricados con aceros fundidos de aleaciones elevadas y tratamientos térmicos en hornos de atmósfera controlada, que garantizan una estructura resistente al impacto, a la fricción y a las elevadas temperaturas provocadas por los turbomotores (que mezclan aire con combustible) y por las condiciones extremas de los motores a GNC/GLP.

Desde el uso de los alojamientos de aluminio, surgió la necesidad de incorporar insertos que sean capaces de soportar las solicitudes (cargas – tensiones) mecánicas que son producidas en la cámara de combustión.

Tipos y conceptos técnicos

SA - Asiento de válvula de admisión.

SE - Asiento de válvula de escape.

Función

- Impedir que la cabeza de la válvula y el alojamiento se hundan.
- Garantizar un cierre perfecto junto con la válvula para dejar hermética la cámara de combustión.
- Asegurar la conductividad térmica para la disipación de calor de la cabeza de la válvula, pues ésta saca aproximadamente un 80% del calor contenido a través del asiento de la misma.
- Mantener las superficies internas con coeficientes de deslizamiento elevados, para garantizar la correcta fluidez de los componentes de la mezcla.

Características indicadas en la columna de medidas

D) Diámetro exterior

d) Diámetro interior

h) Altura

a) Grados del asiento

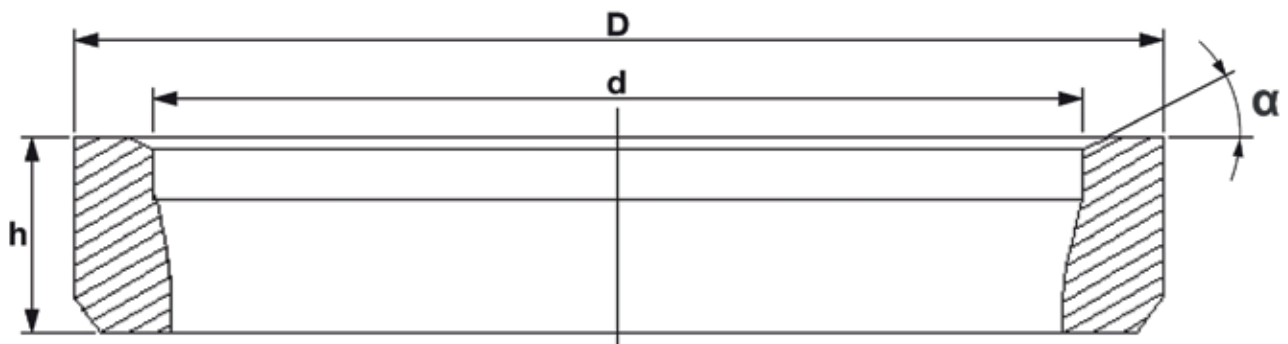



Configuración de las páginas y códigos de artículos



1 MERCEDES-BENZ						MAHLE	
2	3	4	5	6	7		
					D x d x h	8	
Motor OM 352A/314-L1517/18 Turbo, OM 352-L1114 No Turbo	6	EX	SE0480038	STD	38,08 x 28 x 8,45	45°	
Motor OM 352A-L1517, L1518 Turbo	6	EX	SE0480038	STD	38,08 x 28 x 8,45	45°	
Motor OM 366 - OM 364LA Turbo Intercooler	4	IN	SA0480112	STD	43,87 x 34,5 x 7,5	20°	
Motor OM 366 Turbo	4/6	IN	SA0480059	0,1	43,97 x 35 x 7,4	30°	
		IN	SA0480059	0,2	44,07 x 35 x 7,4	30°	
		IN	SA0480059	0,3	44,17 x 35 x 7,4	30°	
		EX	SE0480080	0,1	38,17 x 30 x 8	45°	
		EX	SE0480080	0,2	38,37 x 30 x 8	45°	
		IN	SA0480059	STD	43,87 x 35 x 7,4	30°	
		EX	SE0480080	STD	38,07 x 30 x 8	45°	
		IN	SA0480087	0,1	43,97 x 35 x 7,7	30°	
Motor OM 366, OM 364 Asp. Normal y Turbo	4/6	IN	SA0480087	0,5	44,37 x 35 x 7,7	30°	
		EX	SE0480038	0,1	38,17 x 28 x 8,5	45°	
		EX	SE0480038	0,2	38,27 x 28 x 8,5	45°	
		EX	SE0480038	0,5	38,57 x 28 x 8,5	45°	
		EX	SE0480038	1,00	39,07 x 28 x 8,5	45°	
		EX	SE0480038	2,00	40,07 x 28 x 8,5	45°	
		EX	SE0480038	STD	38,08 x 28 x 8,45	45°	
		IN	SA0480087	STD	43,87 x 35 x 7,7	30°	
Motor OM 447LA-449LA	5/6	IN	SA0480090	0,1	60,2 x 49,3 x 8,35	30°	
		IN	SA0480090	STD	60,1 x 49,3 x 8,35	30°	
		EX	SE0480092	STD	53,1 x 43 x 9,2	45°	
Motor OM 501LA V6 24v., OM 502LA V8 32v., OM 457	6	IN	SA0480070	STD	47,39 x 36,5 x 7,8	30°	
		EX	SE0480032	STD	43,09 x 34,3 x 8	45°	
OM 355 - OM 355 O (ónibus) aspirado	5/6	EX	SE0480044	0,1	40,17 x 31 x 7,47	45°	
		EX	SE0480044	0,2	40,27 x 31 x 7,47	45°	
		IN	SA0480056	STD	51,07 x 37 x 7,47	45°	
		EX	SE0480044	STD	40,07 x 31 x 7,47	45°	
OM314 - OM352 - OM352A (Aspirado/ Turbinado)	4/6	IN	SA0480033	0,1	45,17 x 37 x 8,3	45°	
		IN	SA0480033	0,2	45,27 x 37 x 8,3	45°	
		IN	SA0480033	1,00	46,07 x 37 x 8,3	45°	
		SA0480033	0,00	47,07 x 37 x 8,3	45°		

- 1 Fabricante
- 2 Descripción del motor
 - Datos del Motor
 - Vehículos
 - Año de Fabricación
- 3 Número de cilindros
- 4 Función
 - IN = Admisión
 - EX = Escape
 - IN - EX = Común

- 5 Número de Artículo del asiento de Válvula
 - Ex.: SA 048 0033
 - SA - Asiento de válvula de admisión
 - SE - Asiento de válvula de escape
- 6 Medidas
- 7 Dimensiones
- 8 Ángulo

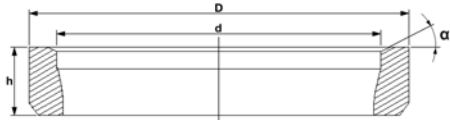

	Nº CIL.	TIPO TYPE	CÓD. MAHLE / METAL LEVE	MEDIDA		
					D x d x h	α
Motor B / BT - Ford F250, F350, F4000, VW 12170, 13170, 15170, 16170, 17210	4/6	IN	SA0210108	STD	47.07 x 37.95 x 6.9	30°
	0,67	EX	SE0210107	STD	43.73 x 34.5 x 6.72	45°
Motor C / CT / CTA / CTAA - VW 14220, 17220, 24220, 26300, 17300, 40300, 25250, Ford 2630, 4030, 2425, 1622, 2422	6	IN	SA0210071	STD	54 x 44.5 x 8.2	30°
		EX	SE0210072	STD	47.1 x 40 x 6.35	45°
		EX	SE0210072	0,10	47.2 x 40 x 6.35	45°

	Nº CIL.	TIPO TYPE	CÓD. MAHLE / METAL LEVE	MEDIDA		
					D x d x h	α
Motor 1.0 8v / 1.3 8v - Endura Nacional / Espanhol - Ká, Fiesta, Courier	4	EX	SE0590129	STD	31.6 x 25.5 x 6	45°
		EX	SE0590129	0,10	31.7 x 25.5 x 6	45°
Motor 6600 - Agrícola, Veicular - 1979->1980	3/4/6	IN	SA0260049	STD	48.25 x 41.8 x 6.45	45°
		EX	SE0260048	STD	40.65 x 34.3 x 7.7	45°

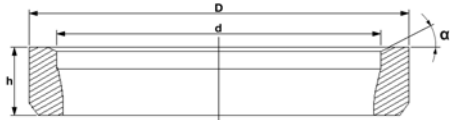
	Nº CIL.	TIPO TYPE	CÓD. MAHLE / METAL LEVE	MEDIDA		
					D x d x h	α
Motor OM314 / OM352 / OM352A	4/6	IN	SA0480033	STD	45.07 x 37 x 8.3	45°
		IN	SA0480033	0,10	45.17 x 37 x 8.3	45°
		IN	SA0480033	0,20	45.27 x 37 x 8.3	45°
		IN	SA0480033	1,00	46.07 x 37 x 8.3	45°
		IN	SA0480033	2,00	47.07 x 37 x 8.3	45°
		EX	SE0480038	STD	38.08 x 28 x 8.45	45°
		EX	SE0480038	0,10	38.17 x 28 x 8.5	45°
		EX	SE0480038	0,20	38.27 x 28 x 8.5	45°
		EX	SE0480038	0,50	38.57 x 28 x 8.5	45°
		EX	SE0480038	1,00	39.07 x 28 x 8.5	45°
Motor OM314 / OM352 / OM352A	4/6	EX	SE0480063	STD	38.07 x 30 x 8.5	45°
		EX	SE0480063	0,10	38.17 x 30 x 8.5	45°
		EX	SE0480063	0,20	38.27 x 30 x 8.5	45°
		EX	SE0480063	0,30	38.37 x 30 x 8.5	45°
		EX	SE0480063	0,40	38.47 x 30 x 8.5	45°
		EX	SE0480063	0,50	38.57 x 30 x 8.5	45°
		EX	SE0480063	1,00	39.07 x 30 x 8.5	45°
Motor OM314 - A partir Nº 132383 / Motor OM314, OM314O e OM352 - A partir Nº 7387373 / Motor OM352A - A partir Nº 738497	4/6	IN	SA0480074	STD	45.87 x 37 x 8.3	45°
		IN	SA0480074	0,10	45.97 x 37 x 8.3	45°
		IN	SA0480074	0,20	46.07 x 37 x 8.3	45°
		IN	SA0480074	0,30	46.17 x 37 x 8.3	45°
		IN	SA0480074	0,40	46.27 x 37 x 8.3	45°
Motor OM355 / OM355O (Ônibus)	5/6	IN	SA0480056	STD	51.07 x 37 x 7.47	45°
		EX	SE0480044	STD	40.07 x 31 x 7.47	45°
		EX	SE0480044	0,10	40.17 x 31 x 7.47	45°
		EX	SE0480044	0,20	40.27 x 31 x 7.47	45°
Motor OM355A / OM355LA	5/6	IN	SA0480079	STD*	51.07 x 37 x 7.69	30°
		IN	SA0480079	0,20	51.26 x 37 x 7.69	30°
Motor OM364LA	4	IN	SA0480112	STD	43.87 x 34.5 x 7.5	20°
Motor OM364A / OM364LA / OM366A / OM366LA	4/6	IN	SA0480059	STD	43.87 x 35 x 7.4	30°
		IN	SA0480059	0,10	43.97 x 35 x 7.4	30°
		IN	SA0480059	0,20	44.07 x 35 x 7.4	30°
		IN	SA0480059	0,30	44.17 x 35 x 7.4	30°
		EX	SE0480080	STD	38.07 x 30 x 8	45°
		EX	SE0480080	0,10	38.17 x 30 x 8	45°

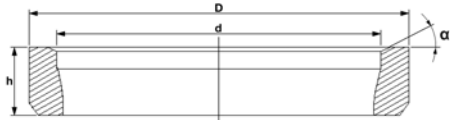
	Nº CIL.	TIPO TYPE	CÓD. MAHLE / METAL LEVE	MEDIDA		
					D x d x h	α
Motor OM364 / OM366	4/6	IN	SA0480087	STD	43.87 x 35 x 7.7	30°
		IN	SA0480087	0,10	43.97 x 35 x 7.7	30°
		IN	SA0480087	0,50	44.37 x 35 x 7.7	30°
		EX	SE0480038	STD	38.08 x 28 x 8.45	45°
		EX	SE0480038	0,10	38.17 x 28 x 8.5	45°
		EX	SE0480038	0,20	38.27 x 28 x 8.5	45°
		EX	SE0480038	0,50	38.57 x 28 x 8.5	45°
		EX	SE0480038	1,00	39.07 x 28 x 8.5	45°
		EX	SE0480038	2,00	40.07 x 28 x 8.5	45°
Motor OM447LA / OM449LA	5/6	IN	SA0480090	STD	60.1 x 49.3 x 8.35	30°
		IN	SA0480090	0,10	60.2 x 49.3 x 8.35	30°
		EX	SE0480092	STD	53.1 x 43 x 9.2	45°
Motor OM457LA Até Euro 3 / OM501LA 24v V6 / OM502LA 32v V8	6/8	IN	SA0480070	STD	47.39 x 36.5 x 7.8	30°
		EX	SE0480032	STD	43.09 x 34.3 x 8	45°

	Nº CIL.	TIPO TYPE	CÓD. MAHLE / METAL LEVE	MEDIDA		
					D x d x h	α
Motor D225 / D226 / D229 - Agrale 7500D, Fiat Trator - Esteira FD6, Pá-Carregadeira, Trator Valmet	3/4/6	IN	SA0130113	STD	43.15 x 36 x 7	45°
		IN	SA0130113	0,10	43.25 x 36 x 7	45°
		IN	SA0130113	0,20	43.35 x 36 x 7	45°
		EX	SE0130029	STD	39.1 x 33 x 7	45°
		EX	SE0130029	0,10	39.2 x 33 x 7	45°
		EX	SE0130029	0,20	39.3 x 33 x 7	45°
Motor D225 / D226 / TD229 / D229EC Aspirado Reforçado - Agrale 7500D, Fiat Trator - Esteira FD6, Pá-Carregadeira, Trator Valmet	3/4/6	IN	SA0130128	STD	43.15 x 36 x 7	30°
		EX	SE0130111	STD	39.1 x 33 x 7	45°
Motor 4.10 /4.10T / 6.10 / 6.10T / 6.10TCA / 6.10TCW - VW 14150, 16210CO, 15180, 13180, 17180, 17210, 17240, 17290, F1000, Ônibus 180A e 210LA, Grupo Gerador 50 Hz, 60/80 Hz	4/6	IN	SA0130085	STD	46.15 x 38.5 x 7.2	60°
		IN	SA0130085	0,10	46.25 x 38.5 x 7.2	60°
		EX	SE0130083	STD	43.1 x 34.4 x 7.4	45°
		EX	SE0130083	0,10	42.2 x 34.4 x 7.4	45°

	Nº CIL.	TIPO TYPE	CÓD. MAHLE / METAL LEVE	MEDIDA		
					D x d x h	α
Motor S4 / P4000	4	IN	SA0570093	STD	48.7 x 40.7 x 6	45°
		EX	SE0570095	STD	39.6 x 33 x 6	45°
		EX	SE0570095	0,10	39.7 x 33 x 6	45°
Motor S4T / S4T Plus / P4000T	4	IN	SA0570094	STD	48.7 x 40.5 x 6	30°
		EX	SE0570095	STD	39.6 x 33 x 6	45°
		EX	SE0570095	0,10	39.7 x 33 x 6	45°
Motor 4203	4	IN	SA0570109	STD	42.17 x 35.5 x 8.5	45°
		EX	SE0570110	STD	36.17 x 30 x 8.5	45°
Motor 4236 / T4236 / Q20B4236 / TQ20B4236 / 4248 / Q20B4236 / TQ20B4236	4/6	IN	SA0570050	STD	51.3 x 37.9 x 7.2	45°
		IN	SA0570050	0,10	51.4 x 37.9 x 7.2	45°
		IN	SA0570050	0,20	51.5 x 37.9 x 7.2	45°
		EX	SE0570053	STD	42.7 x 31.62 x 9.5	45°
		EX	SE0570053	0,10	42.8 x 31.62 x 9.5	45°
		EX	SE0570053	0,20	42.9 x 31.62 x 9.5	45°
Motor 6357 - Industrial / Veicular	6	IN	SA0570097	STD	53 x 41 x 10.5	45°
		EX	SE0570047	STD	47.66 x 34.86 x 9.55	45°

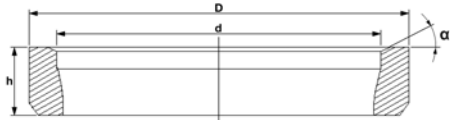
	Nº CIL.	TIPO TYPE	CÓD. MAHLE / METAL LEVE	MEDIDA		
					D x d x h	α
Motor antigo 45° D10 / DS11 - 1967-> / Motor D11, DS10, DS11 - L111	6	EX	SE0760100	STD	52.01 x 40.65 x 10.3	45°
		EX	SE0760100	0,10	52.11 x 40.65 x 10.3	45°
		EX	SE0760100	0,20	52.21 x 40.65 x 10.3	45°
Motor antigo 20° D10 / DS11 - 1967-> / Motor DN11 / DS11 - L112	6	IN	SA0760098	STD	56 x 47.5 x 7.4	20°
		IN	SA0760098	0,50	56.5 x 47.5 x 7.9	20°
Motor novo 20° DSC11 - 113H, K113 Ecológico	6	IN	SA0760103	STD	56.01 x 47.5 x 7.4	20°
Motor novo 45° DSC11 - 113H, K113 Ecológico	6	EX	SE0760104	STD	52 x 39 x 10.3	45°
		EX	SE0760104	0,10	52.1 x 39 x 10.3	45°
		EX	SE0760104	0,20	52.2 x 39 x 10.3	45°

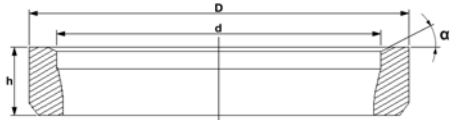
	N° CIL.	TIPO TYPE	CÓD. MAHLE / METAL LEVE	MEDIDA		
					D x d x h	α
Motor 1.3 - Kombi Moderna	4	EX	SE0700116	STD	32.14 x 26 x 8.5	45°
		EX	SE0700116	0,20	32.34 x 26 x 8.5	45°
		EX	SE0700116	0,50	32.64 x 26 x 8.5	45°
Motor 1.6 Refrigerado a Ar	4	IN	SA0700120	STD	37.14 x 31 x 8.5	45°
		IN	SA0700120	0,20	37.34 x 31 x 8.5	45°
		IN	SA0700120	0,50	37.64 x 31 x 8.5	45°
		EX	SE0700119	STD	34.14 x 28 x 8.5	45°
Motor 1.6 - Passat, Gol	4	EX	SE0700123	STD	33.1 x 27.5 x 7.3	45°
Motor 1.8 / 2.0 - Santana	4	IN	SA0700124	STD	39.1 x 33 x 7.8	45°
		IN	SA0700124	0,20	39.3 x 33 x 7.8	45°
		EX	SE0700126	STD	33.6 x 27.6 x 7.3	45°
		EX	SE0700126	0,20	33.8 x 27.6 x 7.3	45°

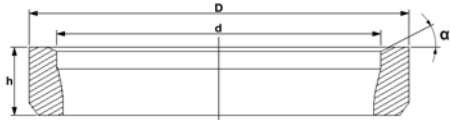
	N° CIL.	TIPO TYPE	CÓD. MAHLE / METAL LEVE	MEDIDA		
					D x d x h	α
Motor TD100B - F88, FB88, FL88, N10B, NL10	6	IN	SA0710058	STD	54.06 x 44.3 x 6.7	30°
		EX	SE0710057	STD	49.06 x 40 x 11.5	45°

MAHLE	ORIGINAL	RIOSULENSE	300 INDY	Linha Motora
SA0130085-STD	961003450033	23608080	A5411	MWM
SA0130085-0,10	961003450033	23608180	A5411-10	MWM
SA0130113-STD	93273450023 / 622603453033	25507080	A5422	MWM
SA0130113-0,10	-	25507180	A5422-10	MWM
SA0130113-0,20	-	25507280	A5422-20	MWM
SA0130128-STD	622603453023	25904080	A5423	MWM
SA0210071-STD	TE3-109.429	23540015	A5278	CUMMINS
SA0210108-STD	3906854	23835015	A5251	CUMMINS
SA0260049-STD	-	23521030	A5416	FORD
SA0480033-STD	3520533131	23514020	A5000	MERCEDES-BENZ
SA0480033-0,10	35820531631 / 3520532231 / 3520533131	23514120	A5000-10	MERCEDES-BENZ
SA0480033-0,20	35820531631 / 3520532231 / 3520533131	23514220	A5000-20	MERCEDES-BENZ
SA0480033-1,00	3520531631 / 3520532231 / 3520533131	23514620	A5000-100	MERCEDES-BENZ
SA0480033-2,00	3520531631 / 3520532231 / 3520533131	23514720	A5000-200	MERCEDES-BENZ
SA0480056-STD	3460530731 / 3550531131	23527020	A5005	MERCEDES-BENZ
SA0480059-STD	3660532031	23530020	A5093	MERCEDES-BENZ
SA0480059-0,10	3660532031 / 3660533531	23530120	A5093-10	MERCEDES-BENZ
SA0480059-0,20	3660532031 / 3660533531	23530220	A5093-20	MERCEDES-BENZ
SA0480059-0,30	3660532031 / 3660533531	23530320	A5093-30	MERCEDES-BENZ
SA0480070-STD	4570531631	23539020	A5372	MERCEDES-BENZ
SA0480074-STD	3520533531	23548020	A5357	MERCEDES-BENZ
SA0480074-0,10	3520533531 / 3520533831 / 352054031	23548120	A5357-10	MERCEDES-BENZ
SA0480074-0,20	3520533531 / 3520533831 / 352054031	23548220	A5357-20	MERCEDES-BENZ
SA0480074-0,30	3520533531 / 3520533831 / 352054031	23548320	A5357-30	MERCEDES-BENZ
SA0480074-0,40	3520533531 / 3520533831 / 352054031	23548420	A5357-40	MERCEDES-BENZ
SA0480079-STD	3450530131	23549220	A5415	MERCEDES-BENZ
SA0480079-0,20	3450530131	23549220	A5415-20	MERCEDES-BENZ
SA0480087-STD	3660530931	23651020	A5003	MERCEDES-BENZ
SA0480087-0,10	3660530931 / 3660531231 / 3660531431	23651120	A5003-10	MERCEDES-BENZ
SA0480087-0,50	3660530931 / 3660531231 / 3660531431	23651520	A5003-50	MERCEDES-BENZ
SA0480090-STD	4220530131	23654020	A5279	MERCEDES-BENZ
SA0480090-0,10	4220530131 / 4470530031	23654120	A5279-10	MERCEDES-BENZ
SA0480112-STD	3660533531 / 3660533931	23990020	A5016	MERCEDES-BENZ
SA0570050-STD	70470053	23523050	A5413	PERKINS (MAXION)
SA0570050-0,10	70470053 / 33152154	23523150	A5413-10	PERKINS (MAXION)
SA0570050-0,20	70470053 / 33152154	23523250	A5413-20	PERKINS (MAXION)
SA0570093-STD	70470095	23666050	A5271	PERKINS (MAXION)
SA0570094-STD	70470094	23667050	A5270	PERKINS (MAXION)
SA0570097-STD	70470052	23775050	A5448	PERKINS (MAXION)
SA0570109-STD	70470051	23870050	A5492	PERKINS (MAXION)
SA0700120-STD	-	25618010	A5296	VOLKSWAGEN
SA0700120-0,20	0401014314	25618210	A5429-20	VOLKSWAGEN
SA0700120-0,50	0401014314	25618510	A5429-50	VOLKSWAGEN
SA0700124-STD	-	25620010	A5217	VOLKSWAGEN
SA0700124-0,20	035103431	25620210	A5427-20	VOLKSWAGEN
SA0710058-STD	467474-3	23529060	A5159	VOLVO
SA0760098-STD	289517FH001	23785035	A5052	SCANIA
SA0760098-0,50	-	23785535	A5333D-50	SCANIA
SA0760103-STD	289517	23787035	A5052	SCANIA
SE0130029-STD	922903450013	23508080	A5090D	MWM
SE0130029-0,10	932703450033	23508180	A5090D-10	MWM
SE0130029-0,20	932703450033	23508280	A5090D-20	MWM
SE0130083-STD	961003450043	23607080	A5412D	MWM
SE0130083-0,10	961003450043	23607180	A5412D-10	MWM
SE0130111-STD	922903453013	23905080	A5424D	MWM
SE0210072-STD	TE3-109.431	23541015	A5273	CUMMINS

MAHLE	ORIGINAL	RIOSULENSE	300 INDY	Linha Motora
SE0210072-0,10	3929005	23541115	A5277-10	CUMMINS
SE0210107-STD	3904105	23834015	A5252	CUMMINS
SE0260048-STD	-	23520030	A5421	FORD
SE0480032-STD	5410530432	23511020	A5368	MERCEDES-BENZ
SE0480038-STD	3520532032	23515020	A5002	MERCEDES-BENZ
SE0480038-0,10	3520530032 / 3520531232 / 3520532032	23515120	A5002-10	MERCEDES-BENZ
SE0480038-0,20	3520530032 / 3520531232 / 3520532032	23515220	A5002-20	MERCEDES-BENZ
SE0480038-0,50	3520530032 / 3520531232 / 3520532032	23515520	A5002-50	MERCEDES-BENZ
SE0480038-1,00	3520530032 / 3520531232 / 3520532032	23515620	A5002-100	MERCEDES-BENZ
SE0480038-2,00	3520530032 / 3520531232	23515720	A5002-200	MERCEDES-BENZ
SE0480044-STD	3460530532 / 3550531032	23516020	A5006	MERCEDES-BENZ
SE0480044-0,10	3460530532 / 3550531032 / 3550531832	23516120	A5006-10	MERCEDES-BENZ
SE0480044-0,20	3460530632 / 3550531032	23516220	A5006-20	MERCEDES-BENZ
SE0480063-STD	3520531532	23531020	A5094	MERCEDES-BENZ
SE0480063-0,10	3520531532 / 3520532032	23531120	A5094-10	MERCEDES-BENZ
SE0480063-0,20	3520531532 / 3520532032	23531220	A5094-20	MERCEDES-BENZ
SE0480063-0,30	3520531532 / 3520532032	23531320	A5094-30	MERCEDES-BENZ
SE0480063-0,40	3520531532	23531420	A5094-40	MERCEDES-BENZ
SE0480063-0,50	3520531532 / 3520532032	23531520	A5094-50	MERCEDES-BENZ
SE0480063-1,00	3520531532 / 3520532032	23531620	A5094-100	MERCEDES-BENZ
SE0480080-STD	3660530432-3660530132	23559020	A5096	MERCEDES-BENZ
SE0480080-0,10	3660530132 / 3660530432 / 3660531232	23559120	A5096-10	MERCEDES-BENZ
SE0480080-0,20	3660530132 / 3660530432 / 3660531232	23559220	A5096-20	MERCEDES-BENZ
SE0480092-STD	4220530032	23655020	A5280	MERCEDES-BENZ
SE0570047-STD	70470004	23517050	A5019	PERKINS (MAXION)
SE0570053-STD	33152153 / 33152139	23524050	A5023	PERKINS (MAXION)
SE0570053-0,10	33152153 / 33152139	23524150	A5023-10	PERKINS (MAXION)
SE0570053-0,20	33152153 / 33152139	23524250	A5023-20	PERKINS (MAXION)
SE0570095-STD	70470096	23668050	A5285	PERKINS (MAXION)
SE0570095-0,10	70470096	23668150	A5285-10	PERKINS (MAXION)
SE0570110-STD	33124428	23871050	A5493	PERKINS (MAXION)
SE0590129-STD	97BM6057A1A	25950030	A5443	FORD
SE0590129-0,10	97BM6057A1A	25950130	A5443-10	FORD
SE0700116-STD	0401014415	25615010	A5490	VOLKSWAGEN
SE0700116-0,20	0401014415	25615210	A5940-20	VOLKSWAGEN
SE0700116-0,50	0401014415	25615510	A5490-50	VOLKSWAGEN
SE0700119-STD	-	25617010	A5297	VOLKSWAGEN
SE0700123-STD	056103441A	25619010	A5311	VOLKSWAGEN
SE0700126-STD	-	25621010	A5218	VOLKSWAGEN
SE0700126-0,20	26103441	-	A5218-20	VOLKSWAGEN
SE0710057-STD	467475-0	23528060	A5158	VOLVO
SE0760100-STD	242672	23786035	A5053	SCANIA
SE0760100-0,10	-	23786135	A5053-10	SCANIA
SE0760100-0,20	-	23786235	A5053-20	SCANIA
SE0760104-STD	372972	23788035	A5293	SCANIA
SE0760104-0,10	-	23788135	A5293-10	SCANIA
SE0760104-0,20	-	23788235	A5293-20	SCANIA

ORIGINAL	MAHLE	RIOSULENSE	300 INDY	LINHA MOTORA
035103431	SA0700124-0,20	25620210	A5427-20	VOLKSWAGEN
0401014314	SA0700120-0,20	25618210	A5429-20	VOLKSWAGEN
0401014314	SA0700120-0,50	25618510	A5429-50	VOLKSWAGEN
0401014415	SE0700116-STD	25615010	A5490	VOLKSWAGEN
0401014415	SE0700116-0,50	25615510	A5490-50	VOLKSWAGEN
0401014415	SE0700116-0,20	25615210	A5940-20	VOLKSWAGEN
056103441A	SE0700123-STD	25619010	A5311	VOLKSWAGEN
242672	SE0760100-STD	23786035	A5053	SCANIA
26103441	SE0700126-0,20	-	A5218-20	VOLKSWAGEN
289517	SA0760103-STD	23787035	A5052	SCANIA
289517FH001	SA0760098-STD	23785035	A5052	SCANIA
33124428	SE0570110-STD	23871050	A5493	PERKINS (MAXION)
33152153 / 33152139	SE0570053-STD	23524050	A5023	PERKINS (MAXION)
33152153 / 33152139	SE0570053-0,10	23524150	A5023-10	PERKINS (MAXION)
33152153 / 33152139	SE0570053-0,20	23524250	A5023-20	PERKINS (MAXION)
3450530131	SA0480079-0,20	23549220	A5415-20	MERCEDES-BENZ
3450530131	SA0480079-STD	23549220	A5415	MERCEDES-BENZ
3460530731 / 3550531131	SA0480056-STD	23527020	A5005	MERCEDES-BENZ
3460530532 / 3550531032	SE0480044-STD	23516020	A5006	MERCEDES-BENZ
3460530532 / 3550531032 / 3550531832	SE0480044-0,10	23516120	A5006-10	MERCEDES-BENZ
3460530632 / 3550531032	SE0480044-0,20	23516220	A5006-20	MERCEDES-BENZ
3520533131	SA0480033-STD	23514020	A5000	MERCEDES-BENZ
3520531631 / 3520532231 / 3520533131	SA0480033-1,00	23514620	A5000-100	MERCEDES-BENZ
3520531631 / 3520532231 / 3520533131	SA0480033-2,00	23514720	A5000-200	MERCEDES-BENZ
3520532032	SE0480038-STD	23515020	A5002	MERCEDES-BENZ
3520530032 / 3520531232 / 3520532032	SE0480038-0,10	23515120	A5002-10	MERCEDES-BENZ
3520530032 / 3520531232 / 3520532032	SE0480038-1,00	23515620	A5002-100	MERCEDES-BENZ
3520530032 / 3520531232 / 3520532032	SE0480038-0,20	23515220	A5002-20	MERCEDES-BENZ
3520530032 / 3520531232	SE0480038-2,00	23515720	A5002-200	MERCEDES-BENZ
3520530032 / 3520531232 / 3520532032	SE0480038-0,50	23515520	A5002-50	MERCEDES-BENZ
3520531532	SE0480063-STD	23531020	A5094	MERCEDES-BENZ
3520531532 / 3520532032	SE0480063-0,10	23531120	A5094-10	MERCEDES-BENZ
3520531532 / 3520532032	SE0480063-1,00	23531620	A5094-100	MERCEDES-BENZ
3520531532 / 3520532032	SE0480063-0,20	23531220	A5094-20	MERCEDES-BENZ
3520531532 / 3520532032	SE0480063-0,30	23531320	A5094-30	MERCEDES-BENZ
3520531532	SE0480063-0,40	23531420	A5094-40	MERCEDES-BENZ
3520531532 / 3520532032	SE0480063-0,50	23531520	A5094-50	MERCEDES-BENZ
3520533531	SA0480074-STD	23548020	A5357	MERCEDES-BENZ
3520533531 / 3520533831 / 352054031	SA0480074-0,10	23548120	A5357-10	MERCEDES-BENZ
3520533531 / 3520533831 / 352054031	SA0480074-0,20	23548220	A5357-20	MERCEDES-BENZ
3520533531 / 3520533831 / 3520534031	SA0480074-0,30	23548320	A5357-30	MERCEDES-BENZ
3520533531 / 3520533831 / 3520534031	SA0480074-0,40	23548420	A5357-40	MERCEDES-BENZ
35820531631 / 3520532231 / 3520533131	SA0480033-0,10	23514120	A5000-10	MERCEDES-BENZ
35820531631 / 3520532231 / 3520533131	SA0480033-0,20	23514220	A5000-20	MERCEDES-BENZ
3660530931	SA0480087-STD	23651020	A5003	MERCEDES-BENZ
3660530931 / 3660531231 / 3660531431	SA0480087-0,10	23651120	A5003-10	MERCEDES-BENZ
3660530931 / 3660531231 / 3660531431	SA0480087-0,50	23651520	A5003-50	MERCEDES-BENZ
3660533531 / 3660533931	SA0480112-STD	23990020	A5016	MERCEDES-BENZ
3660532031	SA0480059-STD	23530020	A5093	MERCEDES-BENZ
3660532031 / 3660533531	SA0480059-0,10	23530120	A5093-10	MERCEDES-BENZ
3660532031 / 3660533531	SA0480059-0,20	23530220	A5093-20	MERCEDES-BENZ
3660532031 / 3660533531	SA0480059-0,30	23530320	A5093-30	MERCEDES-BENZ
3660530432 / 3660530132	SE0480080-STD	23559020	A5096	MERCEDES-BENZ
3660530132 / 3660530432 / 3660531232	SE0480080-0,10	23559120	A5096-10	MERCEDES-BENZ
3660530132 / 3660530432 / 3660531232	SE0480080-0,20	23559220	A5096-20	MERCEDES-BENZ
372972	SE0760104-STD	23788035	A5293	SCANIA

ORIGINAL	MAHLE	RIOSULENSE	300 INDY	LINHA MOTORA
3904105	SE0210107-STD	23834015	A5252	CUMMINS
3906854	SA0210108-STD	23835015	A5251	CUMMINS
3929005	SE0210072-0,10	23541115	A5277-10	CUMMINS
4220530131	SA0480090-STD	23654020	A5279	MERCEDES-BENZ
4220530131 / 4470530031	SA0480090-0,10	23654120	A5279-10	MERCEDES-BENZ
4220530032	SE0480092-STD	23655020	A5280	MERCEDES-BENZ
4570531631	SA0480070-STD	23539020	A5372	MERCEDES-BENZ
467474-3	SA0710058-STD	23529060	A5159	VOLVO
467475-0	SE0710057-STD	23528060	A5158	VOLVO
5410530432	SE0480032-STD	23511020	A5368	MERCEDES-BENZ
622603453023	SA0130128-STD	25904080	A5423	MWM
70470004	SE0570047-STD	23517050	A5019	PERKINS (MAXION)
70470053	SA0570050-STD	23523050	A5413	PERKINS (MAXION)
70470053 / 33152154	SA0570050-0,10	23523150	A5413-10	PERKINS (MAXION)
70470053 / 33152154	SA0570050-0,20	23523250	A5413-20	PERKINS (MAXION)
70470094	SA0570094-STD	23667050	A5270	PERKINS (MAXION)
70470095	SA0570093-STD	23666050	A5271	PERKINS (MAXION)
70470096	SE0570095-STD	23668050	A5285	PERKINS (MAXION)
70470096	SE0570095-0,10	23668150	A5285-10	PERKINS (MAXION)
70470052	SA0570097-STD	23775050	A5448	PERKINS (MAXION)
70470051	SA0570109-STD	23870050	A5492	PERKINS (MAXION)
922903450013	SE0130029-STD	23508080	A5090D	MWM
922903453013	SE0130111-STD	23905080	A5424D	MWM
932703450033	SE0130029-0,10	23508180	A5090D-10	MWM
932703450033	SE0130029-0,20	23508280	A5090D-20	MWM
93273450023 / 622603453033	SA0130113-STD	25507080	A5422	MWM
961003450033	SA0130085-STD	23608080	A5411	MWM
961003450033	SA0130085-0,10	23608180	A5411-10	MWM
961003450043	SE0130083-STD	23607080	A5412D	MWM
961003450043	SE0130083-0,10	23607180	A5412D-10	MWM
97BM6057A1A	SE0590129-STD	25950030	A5443	FORD
97BM6057A1A	SE0590129-0,10	25950130	A5443-10	FORD
TE3-109.429	SA0210071-STD	23540015	A5278	CUMMINS
TE3-109.431	SE0210072-STD	23541015	A5273	CUMMINS

RIOSULENSE	MAHLE	ORIGINAL	300 INDY	LINHA MOTORA
23508080	SE0130029-STD	922903450013	A5090D	MWM
23508180	SE0130029-0,10	932703450033	A5090D-10	MWM
23508280	SE0130029-0,20	932703450033	A5090D-20	MWM
23511020	SE0480032-STD	5410530432	A5368	MERCEDES-BENZ
23514020	SA0480033-STD	3520533131	A5000	MERCEDES-BENZ
23514120	SA0480033-0,10	35820531631 / 3520532231 / 3520533131	A5000-10	MERCEDES-BENZ
23514220	SA0480033-0,20	35820531631 / 3520532231 / 3520533131	A5000-20	MERCEDES-BENZ
23514620	SA0480033-1,00	3520531631 / 3520532231 / 3520533131	A5000-100	MERCEDES-BENZ
23514720	SA0480033-2,00	3520531631 / 3520532231 / 3520533131	A5000-200	MERCEDES-BENZ
23515020	SE0480038-STD	3520532032	A5002	MERCEDES-BENZ
23515120	SE0480038-0,10	3520530032 / 3520531232 / 3520532032	A5002-10	MERCEDES-BENZ
23515220	SE0480038-0,20	3520530032 / 3520531232 / 3520532032	A5002-20	MERCEDES-BENZ
23515520	SE0480038-0,50	3520530032 / 3520531232 / 3520532032	A5002-50	MERCEDES-BENZ
23515620	SE0480038-1,00	3520530032 / 3520531232 / 3520532032	A5002-100	MERCEDES-BENZ
23515720	SE0480038-2,00	3520530032 / 3520531232	A5002-200	MERCEDES-BENZ
23516020	SE0480044-STD	3460530532 / 3550531032	A5006	MERCEDES-BENZ
23516120	SE0480044-0,10	3460530532 / 3550531032 / 3550531832	A5006-10	MERCEDES-BENZ
23516220	SE0480044-0,20	3460530632 / 3550531032	A5006-20	MERCEDES-BENZ
23517050	SE0570047-STD	70470004	A5019	PERKINS (MAXION)
23520030	SE0260048-STD	-	A5421	FORD
23521030	SA0260049-STD	-	A5416	FORD
23523050	SA0570050-STD	70470053	A5413	PERKINS (MAXION)
23523150	SA0570050-0,10	70470053 / 33152154	A5413-10	PERKINS (MAXION)
23523250	SA0570050-0,20	70470053 / 33152154	A5413-20	PERKINS (MAXION)
23524050	SE0570053-STD	33152153 / 33152139	A5023	PERKINS (MAXION)
23524150	SE0570053-0,10	33152153 / 33152139	A5023-10	PERKINS (MAXION)
23524250	SE0570053-0,20	33152153 / 33152139	A5023-20	PERKINS (MAXION)
23527020	SA0480056-STD	3460530731 / 3550531131	A5005	MERCEDES-BENZ
23528060	SE0710057-STD	467475-0	A5158	VOLVO
23529060	SA0710058-STD	467474-3	A5159	VOLVO
23530020	SA0480059-STD	3660532031	A5093	MERCEDES-BENZ
23530120	SA0480059-0,10	3660532031 / 3660533531	A5093-10	MERCEDES-BENZ
23530220	SA0480059-0,20	3660532031 / 3660533531	A5093-20	MERCEDES-BENZ
23530320	SA0480059-0,30	3660532031 / 3660533531	A5093-30	MERCEDES-BENZ
23531020	SE0480063-STD	3520531532	A5094	MERCEDES-BENZ
23531120	SE0480063-0,10	3520531532 / 3520532032	A5094-10	MERCEDES-BENZ
23531220	SE0480063-0,20	3520531532 / 3520532032	A5094-20	MERCEDES-BENZ
23531320	SE0480063-0,30	3520531532 / 3520532032	A5094-30	MERCEDES-BENZ
23531420	SE0480063-0,40	3520531532	A5094-40	MERCEDES-BENZ
23531520	SE0480063-0,50	3520531532 / 3520532032	A5094-50	MERCEDES-BENZ
23531620	SE0480063-1,00	3520531532 / 3520532032	A5094-100	MERCEDES-BENZ
23539020	SA0480070-STD	4570531631	A5372	MERCEDES-BENZ
23540015	SA0210071-STD	TE3-109.429	A5278	CUMMINS
23541015	SE0210072-STD	TE3-109.431	A5273	CUMMINS
23541115	SE0210072-0,10	3929005	A5277-10	CUMMINS
23548020	SA0480074-STD	3520533531	A5357	MERCEDES-BENZ
23548120	SA0480074-0,10	3520533531 / 3520533831 / 352054031	A5357-10	MERCEDES-BENZ
23548220	SA0480074-0,20	3520533531 / 3520533831 / 352054031	A5357-20	MERCEDES-BENZ
23548320	SA0480074-0,30	3520533531 / 3520533831 / 3520534031	A5357-30	MERCEDES-BENZ
23548420	SA0480074-0,40	3520533531 / 3520533831 / 3520534031	A5357-40	MERCEDES-BENZ
23549220	SA0480079-0,20	3450530131	A5415-20	MERCEDES-BENZ
23549220	SA0480079-STD	3450530131	A5415	MERCEDES-BENZ
23559020	SE0480080-STD	3660530432-3660530132	A5096	MERCEDES-BENZ
23559120	SE0480080-0,10	3660530132 / 3660530432 / 3660531232	A5096-10	MERCEDES-BENZ
23559220	SE0480080-0,20	3660530132 / 3660530432 / 3660531232	A5096-20	MERCEDES-BENZ
23607080	SE0130083-STD	961003450043	A5412D	MWM

RIOSULENSE	MAHLE	ORIGINAL	300 INDY	LINHA MOTORA
23607180	SE0130083-0,10	961003450043	A5412D-10	MWM
23608080	SA0130085-STD	961003450033	A5411	MWM
23608180	SA0130085-0,10	961003450033	A5411-10	MWM
23651020	SA0480087-STD	3660530931	A5003	MERCEDES-BENZ
23651120	SA0480087-0,10	3660530931 / 3660531231 / 3660531431	A5003-10	MERCEDES-BENZ
23651520	SA0480087-0,50	3660530931 / 3660531231 / 3660531431	A5003-50	MERCEDES-BENZ
23654020	SA0480090-STD	4220530131	A5279	MERCEDES-BENZ
23654120	SA0480090-0,10	4220530131 / 4470530031	A5279-10	MERCEDES-BENZ
23655020	SE0480092-STD	4220530032	A5280	MERCEDES-BENZ
23666050	SA0570093-STD	70470095	A5271	PERKINS (MAXION)
23667050	SA0570094-STD	70470094	A5270	PERKINS (MAXION)
23668050	SE0570095-STD	70470096	A5285	PERKINS (MAXION)
23668150	SE0570095-0,10	70470096	A5285-10	PERKINS (MAXION)
23775050	SA0570097-STD	70470052	A5448	PERKINS (MAXION)
23785035	SA0760098-STD	289517FH001	A5052	SCANIA
23785535	SA0760098-0,50	-	A5333D-50	SCANIA
23786035	SE0760100-STD	242672	A5053	SCANIA
23786135	SE0760100-0,10	-	A5053-10	SCANIA
23786235	SE0760100-0,20	-	A5053-20	SCANIA
23787035	SA0760103-STD	289517	A5052	SCANIA
23788035	SE0760104-STD	372972	A5293	SCANIA
23788135	SE0760104-0,10	-	A5293-10	SCANIA
23788235	SE0760104-0,20	-	A5293-20	SCANIA
23834015	SE0210107-STD	3904105	A5252	CUMMINS
23835015	SA0210108-STD	3906854	A5251	CUMMINS
23870050	SA0570109-STD	70470051	A5492	PERKINS (MAXION)
23871050	SE0570110-STD	33124428	A5493	PERKINS (MAXION)
23905080	SE0130111-STD	922903453013	A5424D	MWM
23990020	SA0480112-STD	3660533531 / 3660533931	A5016	MERCEDES-BENZ
25507080	SA0130113-STD	93273450023 / 622603453033	A5422	MWM
25507180	SA0130113-0,10	-	A5422-10	MWM
25507280	SA0130113-0,20	-	A5422-20	MWM
25615010	SE0700116-STD	0401014415	A5490	VOLKSWAGEN
25615210	SE0700116-0,20	0401014415	A5940-20	VOLKSWAGEN
25615510	SE0700116-0,50	0401014415	A5490-50	VOLKSWAGEN
25617010	SE0700119-STD	-	A5297	VOLKSWAGEN
25618010	SA0700120-STD	-	A5296	VOLKSWAGEN
25618210	SA0700120-0,20	0401014314	A5429-20	VOLKSWAGEN
25618510	SA0700120-0,50	0401014314	A5429-50	VOLKSWAGEN
25619010	SE0700123-STD	056103441A	A5311	VOLKSWAGEN
25620010	SA0700124-STD	-	A5217	VOLKSWAGEN
25620210	SA0700124-0,20	035103431	A5427-20	VOLKSWAGEN
25621010	SE0700126-STD	-	A5218	VOLKSWAGEN
25904080	SA0130128-STD	622603453023	A5423	MWM
25950030	SE0590129-STD	97BM6057A1A	A5443	FORD
25950130	SE0590129-0,10	97BM6057A1A	A5443-10	FORD

300 INDY	MAHLE	ORIGINAL	RIOSULENSE	LINHA MOTORA
A5000	SA0480033-STD	3520533131	23514020	MERCEDES-BENZ
A5000-10	SA0480033-0,10	35820531631 / 3520532231 / 3520533131	23514120	MERCEDES-BENZ
A5000-100	SA0480033-1,00	3520531631 / 3520532231 / 3520533131	23514620	MERCEDES-BENZ
A5000-20	SA0480033-0,20	35820531631 / 3520532231 / 3520533131	23514220	MERCEDES-BENZ
A5000-200	SA0480033-2,00	3520531631 / 3520532231 / 3520533131	23514720	MERCEDES-BENZ
A5002	SE0480038-STD	3520532032	23515020	MERCEDES-BENZ
A5002-10	SE0480038-0,10	3520530032 / 3520531232 / 3520532032	23515120	MERCEDES-BENZ
A5002-100	SE0480038-1,00	3520530032 / 3520531232 / 3520532032	23515620	MERCEDES-BENZ
A5002-20	SE0480038-0,20	3520530032 / 3520531232 / 3520532032	23515220	MERCEDES-BENZ
A5002-200	SE0480038-2,00	3520530032 / 3520531232	23515720	MERCEDES-BENZ
A5002-50	SE0480038-0,50	3520530032 / 3520531232 / 3520532032	23515520	MERCEDES-BENZ
A5003	SA0480087-STD	3660530931	23651020	MERCEDES-BENZ
A5003-10	SA0480087-0,10	3660530931 / 3660531231 / 3660531431	23651120	MERCEDES-BENZ
A5003-50	SA0480087-0,50	3660530931 / 3660531231 / 3660531431	23651520	MERCEDES-BENZ
A5005	SA0480056-STD	3460530731 / 3550531131	23527020	MERCEDES-BENZ
A5006	SE0480044-STD	3460530532 / 3550531032	23516020	MERCEDES-BENZ
A5006-10	SE0480044-0,10	3460530532 / 3550531032 / 3550531832	23516120	MERCEDES-BENZ
A5006-20	SE0480044-0,20	3460530632 / 3550531032	23516220	MERCEDES-BENZ
A5016	SA0480112-STD	3660533531 / 3660533931	23990020	MERCEDES-BENZ
A5019	SE0570047-STD	70470004	23517050	PERKINS (MAXION)
A5023	SE0570053-STD	33152153 / 33152139	23524050	PERKINS (MAXION)
A5023-10	SE0570053-0,10	33152153 / 33152139	23524150	PERKINS (MAXION)
A5023-20	SE0570053-0,20	33152153 / 33152139	23524250	PERKINS (MAXION)
A5052	SA0760098-STD	289517FH001	23785035	SCANIA
A5052	SA0760103-STD	289517	23787035	SCANIA
A5053	SE0760100-STD	242672	23786035	SCANIA
A5053-10	SE0760100-0,10	-	23786135	SCANIA
A5053-20	SE0760100-0,20	-	23786235	SCANIA
A5090D	SE0130029-STD	922903450013	23508080	MWM
A5090D-10	SE0130029-0,10	932703450033	23508180	MWM
A5090D-20	SE0130029-0,20	932703450033	23508280	MWM
A5093	SA0480059-STD	3660532031	23530020	MERCEDES-BENZ
A5093-10	SA0480059-0,10	3660532031 / 3660533531	23530120	MERCEDES-BENZ
A5093-20	SA0480059-0,20	3660532031 / 3660533531	23530220	MERCEDES-BENZ
A5093-30	SA0480059-0,30	3660532031 / 3660533531	23530320	MERCEDES-BENZ
A5094	SE0480063-STD	3520531532	23531020	MERCEDES-BENZ
A5094-10	SE0480063-0,10	3520531532 / 3520532032	23531120	MERCEDES-BENZ
A5094-100	SE0480063-1,00	3520531532 / 3520532032	23531620	MERCEDES-BENZ
A5094-20	SE0480063-0,20	3520531532 / 3520532032	23531220	MERCEDES-BENZ
A5094-30	SE0480063-0,30	3520531532 / 3520532032	23531320	MERCEDES-BENZ
A5094-40	SE0480063-0,40	3520531532	23531420	MERCEDES-BENZ
A5094-50	SE0480063-0,50	3520531532 / 3520532032	23531520	MERCEDES-BENZ
A5096	SE0480080-STD	3660530432-3660530132	23559020	MERCEDES-BENZ
A5096-10	SE0480080-0,10	3660530132 / 3660530432 / 3660531232	23559120	MERCEDES-BENZ
A5096-20	SE0480080-0,20	3660530132 / 3660530432 / 3660531232	23559220	MERCEDES-BENZ
A5158	SE0710057-STD	467475-0	23528060	VOLVO
A5159	SA0710058-STD	467474-3	23529060	VOLVO
A5217	SA0700124-STD	-	25620010	VOLKSWAGEN
A5218	SE0700126-STD	-	25621010	VOLKSWAGEN
A5218-20	SE0700126-0,20	26103441	-	VOLKSWAGEN
A5251	SA0210108-STD	3906854	23835015	CUMMINS
A5252	SE0210107-STD	3904105	23834015	CUMMINS
A5270	SA0570094-STD	70470094	23667050	PERKINS (MAXION)
A5271	SA0570093-STD	70470095	23666050	PERKINS (MAXION)
A5273	SE0210072-STD	TE3-109.431	23541015	CUMMINS
A5277-10	SE0210072-0,10	3929005	23541115	CUMMINS

300 INDY	MAHLE	ORIGINAL	RIOSULENSE	LINHA MOTORA
A5278	SA0210071-STD	TE3-109.429	23540015	CUMMINS
A5279	SA0480090-STD	4220530131	23654020	MERCEDES-BENZ
A5279-10	SA0480090-0,10	4220530131 / 4470530031	23654120	MERCEDES-BENZ
A5280	SE0480092-STD	4220530032	23655020	MERCEDES-BENZ
A5285	SE0570095-STD	70470096	23668050	PERKINS (MAXION)
A5285-10	SE0570095-0,10	70470096	23668150	PERKINS (MAXION)
A5293	SE0760104-STD	372972	23788035	SCANIA
A5293-10	SE0760104-0,10	-	23788135	SCANIA
A5293-20	SE0760104-0,20	-	23788235	SCANIA
A5296	SA0700120-STD	-	25618010	VOLKSWAGEN
A5297	SE0700119-STD	-	25617010	VOLKSWAGEN
A5311	SE0700123-STD	056103441A	25619010	VOLKSWAGEN
A5333D-50	SA0760098-0,50	-	23785535	SCANIA
A5357	SA0480074-STD	3520533531	23548020	MERCEDES-BENZ
A5357-10	SA0480074-0,10	3520533531 / 3520533831 / 352054031	23548120	MERCEDES-BENZ
A5357-20	SA0480074-0,20	3520533531 / 3520533831 / 352054031	23548220	MERCEDES-BENZ
A5357-30	SA0480074-0,30	3520533531 / 3520533831 / 3520534031	23548320	MERCEDES-BENZ
A5357-40	SA0480074-0,40	3520533531 / 3520533831 / 3520534031	23548420	MERCEDES-BENZ
A5368	SE0480032-STD	5410530432	23511020	MERCEDES-BENZ
A5372	SA0480070-STD	4570531631	23539020	MERCEDES-BENZ
A5411	SA0130085-STD	961003450033	23608080	MWM
A5411-10	SA0130085-0,10	961003450033	23608180	MWM
A5412D	SE0130083-STD	961003450043	23607080	MWM
A5412D-10	SE0130083-0,10	961003450043	23607180	MWM
A5413	SA0570050-STD	70470053	23523050	PERKINS (MAXION)
A5413-10	SA0570050-0,10	70470053 / 33152154	23523150	PERKINS (MAXION)
A5413-20	SA0570050-0,20	70470053 / 33152154	23523250	PERKINS (MAXION)
A5415	SA0480079-STD	3450530131	23549220	MERCEDES-BENZ
A5415-20	SA0480079-0,20	3450530131	23549220	MERCEDES-BENZ
A5416	SA0260049-STD	-	23521030	FORD
A5421	SE0260048-STD	-	23520030	FORD
A5422	SA0130113-STD	93273450023 / 622603453033	25507080	MWM
A5422-10	SA0130113-0,10	-	25507180	MWM
A5422-20	SA0130113-0,20	-	25507280	MWM
A5423	SA0130128-STD	622603453023	25904080	MWM
A5424D	SE0130111-STD	922903453013	23905080	MWM
A5427-20	SA0700124-0,20	035103431	25620210	VOLKSWAGEN
A5429-20	SA0700120-0,20	0401014314	25618210	VOLKSWAGEN
A5429-50	SA0700120-0,50	0401014314	25618510	VOLKSWAGEN
A5443	SE0590129-STD	97BM6057A1A	25950030	FORD
A5443-10	SE0590129-0,10	97BM6057A1A	25950130	FORD
A5448	SA0570097-STD	70470052	23775050	PERKINS (MAXION)
A5490	SE0700116-STD	0401014415	25615010	VOLKSWAGEN
A5490-50	SE0700116-0,50	0401014415	25615510	VOLKSWAGEN
A5492	SA0570109-STD	70470051	23870050	PERKINS (MAXION)
A5493	SE0570110-STD	33124428	23871050	PERKINS (MAXION)
A5940-20	SE0700116-0,20	0401014415	25615210	VOLKSWAGEN

MAHLE

MAHLE Metal Leve S.A.
Rodovia Eng. João Tosello (SP 147), km 96
Limeira (SP), Brasil
Telefone: +55 (19) 3404-7761

www.mahle-aftermarket.com

PUBLICAÇÃO PARA O BRASIL

Versão: Abril 2019